



Preliminary Servicing & Stormwater Management Report for:

Ainley Farm Subdivision
Township of Centre Wellington (Elora)

GMBP File: 411009
July 3, 2019

TABLE OF CONTENTS

1.0	INTRODUCTION	1
2.0	SITE INFORMATION	1
3.0	EXISTING CONDITIONS	2
3.1	LAND USE	2
3.2	TOPOGRAPHY	2
3.3	SOILS	2
4.0	PROPOSED DEVELOPMENT	3
4.1	SITE GRADING	3
4.2	STREETS	3
4.3	WATER SUPPLY	3
4.4	SANITARY SEWER	4
4.5	STORM SEWER	4
4.6	DEWATERING	4
4.7	FOUNDATION DRAINAGE	5
5.0	STORMWATER MANAGEMENT	5
5.1	DESIGN CRITERIA	5
5.2	STORMWATER MANAGEMENT APPROACH	6
5.3	STORMWATER MANAGEMENT PLAN	7
5.3.1	<i>LOT LEVEL CONTROLS</i>	7
5.3.2	<i>CONVEYANCE CONTROLS</i>	7
5.3.3	<i>END-OF-PIPE CONTROLS</i>	8
5.3.4	<i>MINOR / MAJOR DRAINAGE SYSTEM</i>	21
5.4	WATER BUDGET	22
6.0	SEDIMENT AND EROSION CONTROL PLAN	23
7.0	MAINTENANCE PLAN	23
8.0	CONCLUSIONS	24

LIST OF FIGURES

	After Page
1. Key Map	1
2. Draft Plan of Subdivision	3
3. Existing Conditions Storm Drainage Area Plan	9
4. Post-Development Storm Drainage Area Plan	13
5. Major Drainage Plan	19

APPENDICES

Appendix A	Preliminary Geotechnical Investigation – CMT Engineering Inc. (March 29, 2006)
Appendix B	Groundwater Elevation Monitoring – CMT Engineering Inc. (October 12, 2012)
Appendix C	Stormwater Management Analysis
Appendix D	Water Budget Analysis

**PRELIMINARY SERVICING &
STORMWATER MANAGEMENT REPORT
AINLEY FARM SUBDIVISION
TOWNSHIP OF CENTRE WELLINGTON (ELORA)
July 3, 2019
Our File: 411009**

1.0 INTRODUCTION

In support of the Draft Plan of Subdivision Application for Part of Lots 17 and 18, Concession 12 in the Township of Centre Wellington (Geographic Township of Nichol) herein after referred to as the Ainley Farm Subdivision, GM BluePlan Engineering Limited have prepared this report to address the preliminary servicing and stormwater management requirements for the site and to address the comments received from Grand River Conservation Authority (dated July 31, 2018).

The servicing and stormwater management techniques were derived from the recommendations presented in the following reports:

- Stormwater Management Plan for The North Valley Subdivision (Cambridge Engineering and Planning Consultants Limited, January 1994),
- Design Report, Ville Lora Downs North Subdivision, Phase III (Gamsby and Mannerow Limited, July 2004),
- Design Report, Ville Lora Downs Subdivision, Stage VI (Gamsby and Mannerow Limited, April 1998),
- Preliminary Geotechnical Investigation completed CMT Engineering Inc. (March 29, 2006), and
- Environmental Impact Study completed by North-South Environmental Inc. (June 2006).

Together, these reports form the overview for the development of these lands while maintaining the adjacent natural features.

2.0 SITE INFORMATION

Figure 1 shows the location of the Ainley Farm Subdivision and the surrounding area. The 21.46-hectare site is bound by existing agricultural and future development lands to the north, Gerrie Road to the east, existing residential lands to the south (Ville Lora Downs Subdivision, Phase V and Phase VI) and existing wetland and residential lands to the west (Ville Lora Downs North Subdivision, Phase III).

411009
AINLEY FARM
SUBDIVISION
TOWNSHIP OF CENTRE
WELLINGTON (ELORA)

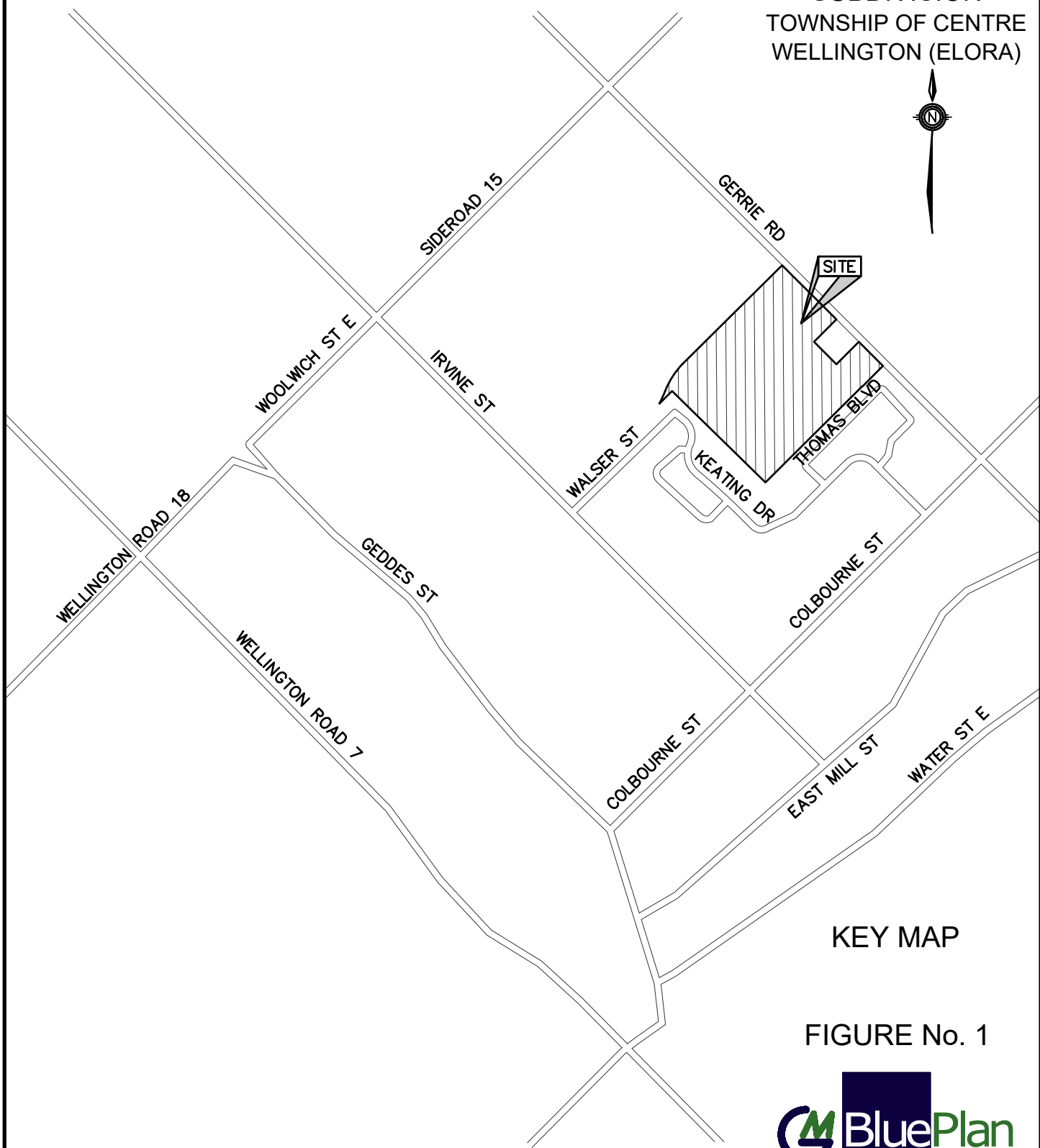

KEY MAP

FIGURE No. 1



JOB NUMBER 411009
FEBRUARY 2019
NOT TO SCALE

3.0 EXISTING CONDITIONS

3.1 LAND USE

The site is currently comprised of agricultural fields and a natural heritage feature consisting of a woodlot and wetland. The existing site features are shown on the General Plans (GM BluePlan Engineering Limited Drawing No. 1 to 4).

3.2 TOPOGRAPHY

The topography throughout the Ainley Farm Subdivision is undulating and consists of rolling slopes with gradients ranging from 0.5% to 20%. Original ground elevations on site range from approximately 410.0m to approximately 416.0m. The northeastern portion of the site generally drains in a northeast direction towards Gerrie Road. The remainder of the site generally drains in a southwest direction towards the existing wetland, ultimately discharging to the existing channel located immediately south of the wetland. The northwestern portion of the site, adjacent to the existing Walser Street right-of-way, drains in a southerly direction towards Walser Street.

3.3 SOILS

The predominant surface soil type on the site is Harriston Loam (Soil Survey of Wellington County Report No. 35). Harriston Loam has a hydrologic soil classification of BC and generally has good drainage characteristics.

The Preliminary Geotechnical Investigation by CMT Engineering Inc. (March 2006) established the characteristics of the underlying soils. The boreholes identified the underlying soils as topsoil overlying organic silt, silt or sandy silt, silt till or sandy silt till, sand or silty sand and clayey silt. The results of the geotechnical investigation are included in Appendix 'A'.

4.0 PROPOSED DEVELOPMENT

The Draft Plan of Subdivision, prepared by Black, Shoemaker, Robinson & Donaldson Limited (December 11, 2018) (Figure 2), illustrates the proposed lot fabric, internal roads, park block, and open space areas and stormwater management blocks.

Access to the 21.46-hectare development will be provided via Gerrie Road and the extension of Walser Street.

Within the development, there are 116 single family lots, one (1) multi-family block, one (1) apartment block, one (1) open space block, one (1) park block and two (2) stormwater management blocks.

In addition, three (3) future single detached lots will be created on the north side of Walser Avenue through the extension of Walser Avenue into the Ainsley Farm property (Future Development Block 124).

4.1 SITE GRADING

The site layout and internal road network for the Ainley Farm Subdivision are shown on the General Plans (GM BluePlan Engineering Limited Drawing No. 1 to 4). The grade and elevation of the internal streets are controlled by the existing centre line elevations of Walser Street and Gerrie Road, the major overland flow route to the stormwater management facilities and the elevation of the existing sanitary sewers on Walser Street and Keating Drive.

The site has been graded to match the existing elevations along the property boundary of the adjacent lands. Minor grading on the adjacent lands located along the north boundary of the site is required. The adjacent lands along the north boundary of the site are owned by the Developer (James Keating Construction (2004) Limited).

4.2 STREETS

All streets will be constructed with a minimum grade of 0.5% and a maximum grade of 8.0% as per Township of Centre Wellington standards. An urban road cross-section (20 m right-of-way width), with concrete curb and gutter will be provided for Street No.1, 2, 3, 4 and the extension of Walser Street, as per Township of Centre Wellington Standard Drawing STD R1.

Concrete sidewalks (1.5 metre wide) will be constructed along both sides of the Walser Street extension and Street No. 1, 2, 3 and 4.

4.3 WATER SUPPLY

As part of the Ville Lora Downs North Subdivision Phase III, a 200mm diameter watermain was terminated at the easterly limit of Walser Street. There is currently no watermain on Gerrie Road across the frontage of the Ainley Farm Subdivision.

Water supply for the Ainley Farm Subdivision will be provided via the extension of a 200mm diameter watermain, along the Walser Street extension, Street No. 2 and a portion of Street No. 1. A 150mm diameter watermain will also be extended along the remainder of Street No. 1, Street No. 3, and Street No. 4.

411009
AINLEY FARM
SUBDIVISION
TOWNSHIP OF CENTRE
WELLINGTON (ELORA)

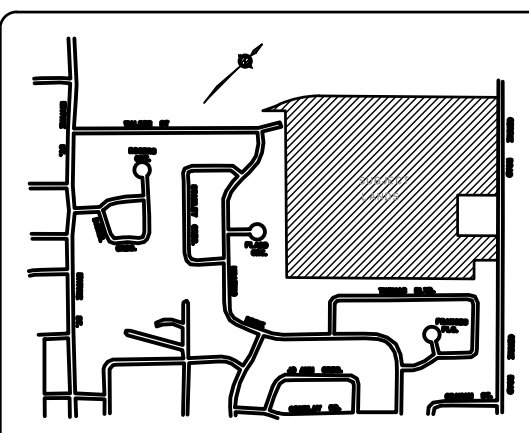
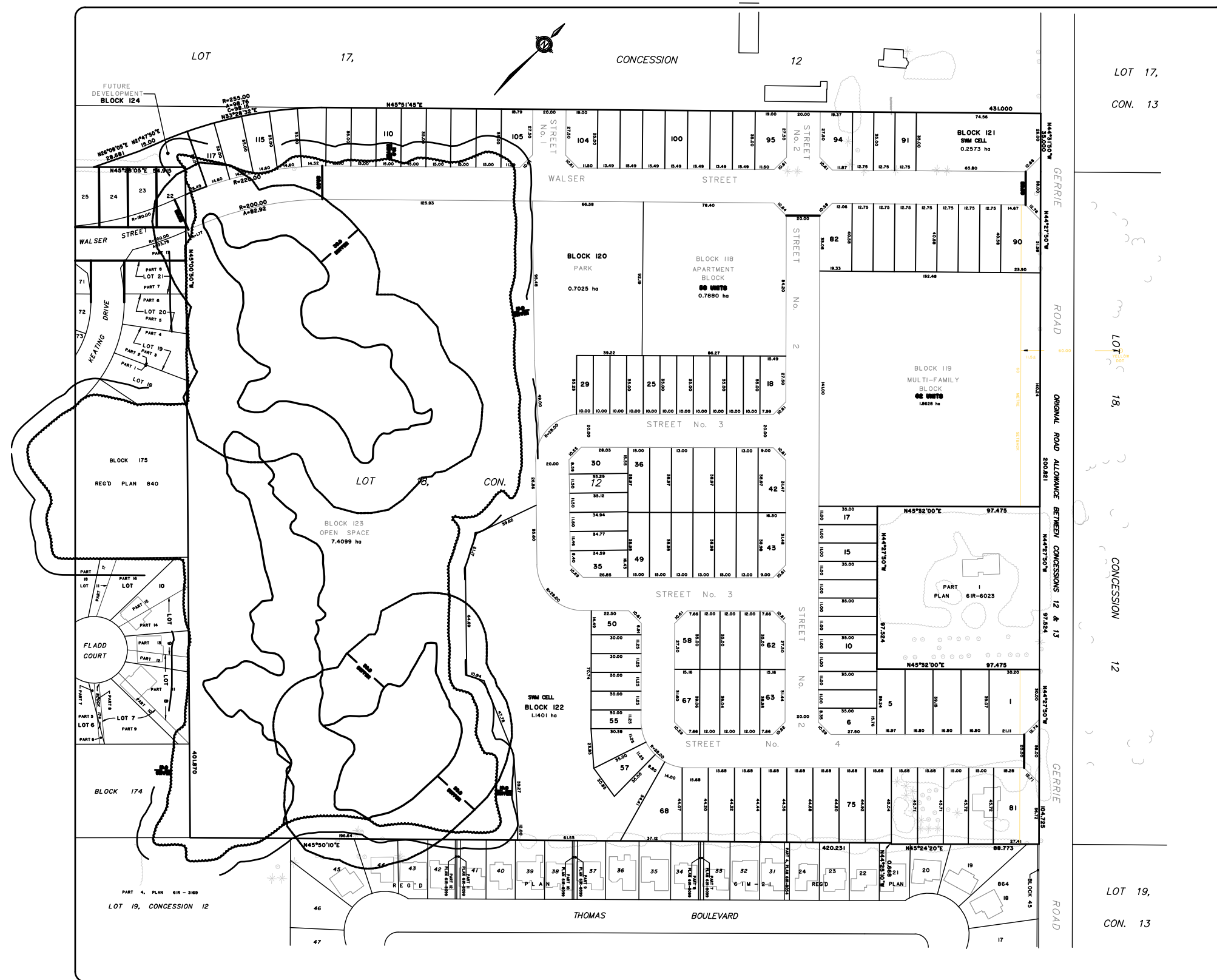

KEY PLAN N.T.S.

ADDITIONAL INFORMATION REQUIRED UNDER SECTION 51 (17) OF THE PLANNING ACT

- 51 (17) (a) - (c) AS SHOWN
- (d) SEE SCHEDULE
- (e) AS SHOWN
- (f) MUNICIPAL WATER SUPPLY
- (g) HARRISTON LOAM
- (h) AS SHOWN
- (i) MUNICIPAL STORM AND SANITARY SEWERS
- (j) NONE KNOWN

OWNERS CERTIFICATE

WE HEREBY AUTHORIZE BLACK, SHOEMAKER, ROBINSON, AND DONALDSON LIMITED, ONTARIO LAND SURVEYORS, URBAN AND RURAL PLANNERS TO SUBMIT THIS DRAFT PLAN OF PROPOSED SUBDIVISION.

DATE _____ JAMES KEATING CONSTRUCTION (2004) LTD.

SURVEYOR'S CERTIFICATE

I HEREBY CERTIFY THAT THE BOUNDARIES OF THE LANDS TO BE SUBDIVIDED AND THEIR RELATIONSHIP TO THE ADJACENT LANDS ARE ACCURATELY AND CORRECTLY SHOWN.

DATE _____ IAN D. ROBINSON
ONTARIO LAND SURVEYOR

METRIC
DISTANCES SHOWN ON THIS PLAN ARE IN METRES AND CAN BE CONVERTED TO FEET BY DIVIDING BY 0.3048

RELEVANT INFORMATION

LOTS/BLOCKS	LAND USE	UNITS	AREAS (ha)
LOTS 1 TO 117	SINGLE-DETACHED RESIDENTIAL	117	6.0442
BLOCK 118	APARTMENT SITE	58	0.7880
BLOCK 119	CLUSTER TOWNHOUSES	18628	1.8628
BLOCK 120	PARK	62	0.7059
BLOCKS 121 & 122	STORMWATER MANAGEMENT		1.3974
BLOCK 123	OPEN SPACE		7.3820
STREETS		4	5.2004
BLOCK 124	FUTURE DEVELOPMENT		0.0816
TOTAL		241	21.4603

NOTES:
ELEVATIONS AND RELEVANT INFORMATION TAKEN FROM

DRAFT PLAN OF SUBDIVISION
OF PART OF
LOTS 17 & 18, CONCESSION 12
TOWNSHIP OF CENTRE WELLINGTON
(GEOGRAPHIC TOWNSHIP OF NICHOL)
COUNTY OF WELLINGTON
SCALE 1:1000

BLACK, SHOEMAKER, ROBINSON & DONALDSON LIMITED
101-257 Woodsm Rd. W. Guelph, Ontario N1H 8J1
TEL: (519) 822-4031 FAX: (519) 822-1220 WWW.BSRD.COM

DATE: OCTOBER 9, 2018
DRAWN BY: KS
PROJECT: 04-5865-18

DRAFT PLAN OF SUBDIVISION

FIGURE No. 2



4.4 SANITARY SEWER

During the municipal servicing of the Ville Lora Downs North Subdivision Phase III, a 200mm diameter sanitary sewer was designed, approved and constructed on Walser Street. The existing 200mm diameter sanitary sewer is currently terminated at the easterly limit of Walser Street. As part of the Ville Lora Downs Subdivision, Phase VI, a 200mm diameter sanitary sewer was also designed, approved and constructed on Keating Drive. There are currently no sanitary sewers on Gerrie Road across the frontage of the Ainley Farm.

Sanitary service for the Ainley Farm Subdivision will be provided via connections to both the existing 200mm diameter sanitary sewer on Walser Street and the existing 200mm diameter sanitary sewer on Keating Drive.

The extension of a 200mm diameter sanitary sewer along the Walser Street extension will service the lots fronting on to Walser Street, as well as a portion of the lots fronting onto Street No. 2. The extension of a 200mm diameter sanitary sewer on easement through Drimmie Part to Street No. 1, from the existing 200mm diameter sanitary sewer on Keating Drive, will service the remainder of the subdivision (Street No. 2, Street No. 3 and Street No. 4).

4.5 STORM SEWER

The storm sewer system for the Ainley Farm Subdivision will be sized to convey the 5-year design storm event and the storm sewer system will discharge to the two (2) proposed stormwater management facilities or to the existing storm sewer on Walser Street.

The storm sewers on Street No. 1, Street No. 3, Street No. 4, a portion of Street No. 2 and a portion of the Walser Street extension will discharge to the proposed Stormwater Management Facility No. 1 located to the east of the existing wetland.

The storm sewers on the remainder of Street No. 2, along with a portion of the Walser Street extension, will discharge to the proposed Stormwater Management Facility No. 2 located to the west of Gerrie Road.

The storm sewers on the remainder of the Walser Street extension will discharge directly to the existing storm sewer system on Walser Street, ultimately discharging to the existing storm sewers on Keating Drive.

4.6 DEWATERING

Dewatering may be required during the installation of sanitary sewer, storm sewer and watermain. A Permit to Take Water (PTTW) or an Environmental Activity and Sector Registry (EASR) from the Ministry of Environment, Conservation and Parks (MECP) will be required if dewatering activities will involve the removal of more than 400,000 litres of groundwater per day from the site.

If dewatering activities are required during the installation of sewers and watermain, all discharge will be directed to the interim sediment control pond prior to discharge from the site.

As part of the area grading of the site, the interim stormwater management facility will be constructed and will act as an interim sedimentation control pond for the remainder of the municipal servicing and home building construction. This will prevent sediment from being discharged to the wetland. Upon build-out, accumulated sediment will be collected and removed from the interim sediment control pond before it is constructed on Stormwater Management Facility No. 1.

4.7 FOUNDATION DRAINAGE

As per the Township of Centre Wellington municipal standards, foundation drainage will be provided via sump pits and sump pumps in each residential unit, ultimately discharging via individual storm sewer lateral connections to the storm sewer system located within the municipal right-of-way.

5.0 STORMWATER MANAGEMENT

5.1 DESIGN CRITERIA

The studies, policies and guidelines used to develop the stormwater management plan for this development were as follows:

- 1) Stormwater Management Planning and Design Manual, 2003
- 2) Design Principles for Stormwater Management Facilities, 1996
- 3) The Interim Stormwater Quality Control Guidelines, 1991
- 4) The Stormwater Quality Best Management Practices Manual, 1991
- 5) The MTO Drainage Management Technical Guidelines, 1989
- 6) The Ontario Urban Design Guidelines, 1987

The objectives of the stormwater management plan are as follows:

- a) Provide Enhanced (80% Total Suspended Solids) water quality control prior to discharge to the existing wetland and to an existing tributary of the Grand River.
- b) Provide quantity control for the full range of design storms to attenuate post-development runoff to the existing condition level.
- c) Match pre- and post-development infiltration rates.
- d) Route the Regional Storm to minimize flood damage.

A three-hour duration rainfall event was used to generate the mass rainfall data required for the 2, 5, 10, 25, 50 and 100-year design storms. The Fergus Shand Dam Chicago parameters and the total depth of rainfall for each storm are as follows:

Table No. 1: Chicago Rainfall Distribution Parameters

	2-Year	5-Year	10-Year	25-Year	50-Year	100-Year
a =	695.047	1459.072	2327.596	3701.648	5089.418	6933.019
b =	6.387	13.690	19.500	25.500	30.000	34.699
c =	0.793	0.850	0.894	0.937	0.967	0.998
r =	0.38	0.38	0.38	0.38	0.38	0.38
Duration = (minutes)	180	180	180	180	180	180
Rainfall Depth = (mm)	33.014	49.792	61.359	75.581	86.737	97.921

The SCS infiltration method was used in the runoff calculations. The CN parameters used in the MIDUSS modelling are as follows:

Table No. 2: SCS Curve Number Parameters

	IMPERVIOUS AREAS	PERVIOUS AREAS
Residential	98	78
Agricultural	98	74
Wetland/Forest	98	50

The hydrologic model MIDUSS was used to create the runoff hydrographs and to route the flows through the storage structures.

5.2 STORMWATER MANAGEMENT APPROACH

In line with current practices and guidelines, the stormwater management plan for the Ainley Farm Subdivision is a “treatment train” to attenuate post-development flows and to provide Enhanced (80% total suspended solids removal) water quality control treatment prior to discharge from the site. The “treatment train” will include a combination of lot level, conveyance and end-of-pipe best management practices.

Lot level controls will simply consist of directing roof leaders to grassed areas and grassed swales.

Conveyance controls will include the use of storm sewers, grassed swales, four (4) oil/grit separator structures for Stormwater Management Facility No.1 and Stormwater Management Facility No.2.

End-of-pipe controls will be provided by two (2) extended detention stormwater management facilities designed to attenuate post-development runoff prior to discharge from the site. Runoff generated from Stormwater Management Facility No.1 will discharge to the existing wetland, ultimately discharging to the existing swale in Drimmie Park and the existing storm sewers on Keating Drive. The stormwater management facility has been designed as a wetland with 5,464m³ of storage, discharging via a multi-stage outlet consisting of a minor outlet with a 300mm diameter orifice plate and a major outlet with a 350mm diameter orifice place, as well as a 20m wide overflow weir.

Runoff generated from Stormwater Management Facility No.2 will discharge to the roadside ditch along Gerrie Road, ultimately discharging to a tributary of the Grand River. The stormwater management facility has been designed as a wetland with 1,195m³ of storage, discharging via a multi-stage outlet consisting of a 120mm knockout for minor storms and a 260mm orifice plate for major storms, as well as a 10m wide overflow weir.

A small portion of runoff from the westerly portion of Walser Street will discharge uncontrolled to the existing storm sewer system on Walser Street.

Major storm flows from the development will sheetflow overland via the municipal right-of-ways to either Stormwater Management Facility No.1 or Stormwater Management Facility No. 2.

This combination of lot-level, conveyance and end-of-pipe controls will control the release of the runoff from the site.

5.3 STORMWATER MANAGEMENT PLAN

The best management practices (BMP's) in the Stormwater Management Planning and Design Manual (2003) were screened. Those found to be applicable to this development are discussed in the following sections.

5.3.1 LOT LEVEL CONTROLS

Stormwater management practices recommended to provide lot level control on this site are as follows:

a) Roof Drainage to Ground Surface

The driveways and front yards will drain to the street. The roof and rear yard will generally drain to the rear of the lot with exception for lots with back to front drainage.

The roof runoff will be filtered across the grassed surface and some will infiltrate. The runoff for any event large enough to generate flow to the swale system will be adequately filtered by the grass enroute.

b) Rear Yard Swales

The lots will be graded to current Township of Centre Wellington Standards. Where practical, the length of the rear lot swales between catch basins will be increased to extend the contact time with the grassed surfaces.

To promote infiltration on the lots and in the swales, it is recommended that the average depth of graded topsoil be 300 mm.

5.3.2 CONVEYANCE CONTROLS

The storm conveyance system for the development will consist of grassed swales, storm sewers, major overland channel and four (4) oil/grit separator structures. Conveyance controls will be achieved through the regular maintenance of the grassed swales, storm sewers, major overland channel, and oil/grit separator structures as part of the Township's annual maintenance program. Maintenance requirements will include the annual removal of accumulated sediments and debris from manholes, catch basins, and oil/grit separator structures.

5.3.3 END-OF-PIPE CONTROLS

a) Existing Conditions

Under existing conditions, the majority of the site is utilized for agricultural purposes. For hydrologic modelling purposes, the 21.46-hectare site and 1.24 hectares of external areas was modelled as seven (7) catchments. These catchments are shown on the Existing Conditions Storm Drainage Area Plan (Figure 3).

Catchment 10 (7.76 hectares, 0% impervious) consists primarily of agricultural lands and an existing residential lot.

Catchment 11 (0.13 hectares, 0% impervious) represents the external lands, which consists primarily of agricultural lands of an existing residential lot.

Runoff generated from Catchment 10 and 11 currently sheetflows overland in an east to west direction, ultimately discharging to the existing wetland.

Catchment 20 (6.65 hectares, 0% impervious) consists primarily of agricultural lands and an existing residential lot.

Catchment 21 (0.82 hectares, 0% impervious) represents external lands consisting of an undeveloped residential lot.

Runoff generated from Catchment 20 and 21 currently sheetflows overland to the existing roadside ditch along Gerrie Road and ultimately to a tributary of the Grand River.

Catchment 30 (0.22 hectares, 0% impervious) represents the external lands, which consists primarily of an existing wetland and agricultural lands.

Runoff generated from Catchment 30 currently sheetflows overland, ultimately discharging to the existing wetland.

Catchment 40 (7.12 hectares, 0% impervious) represents the south-westerly portion of the site, consisting of a natural heritage feature (wetland and woodlot).

Runoff generated from Catchment 40 currently sheetflows overland in an east to west direction, discharging to an existing swale in Drimmie Park and ultimately the existing storm sewer system on Keating Drive.

411009
 AINLEY FARM
 SUBDIVISION
 TOWNSHIP OF CENTRE
 WELLINGTON (ELORA)

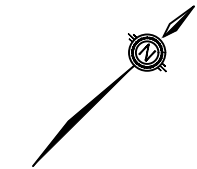

LEGEND

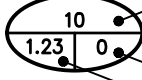
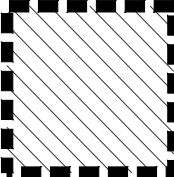
-  DRAINAGE AREA BOUNDARY
-  CATCHMENT NUMBER
% IMPERVIOUS AREA IN HECTARES
-  EXTERNAL LANDS

EXISTING
 CONDITIONS STORM
 DRAINAGE AREA
 PLAN

FIGURE No. 3

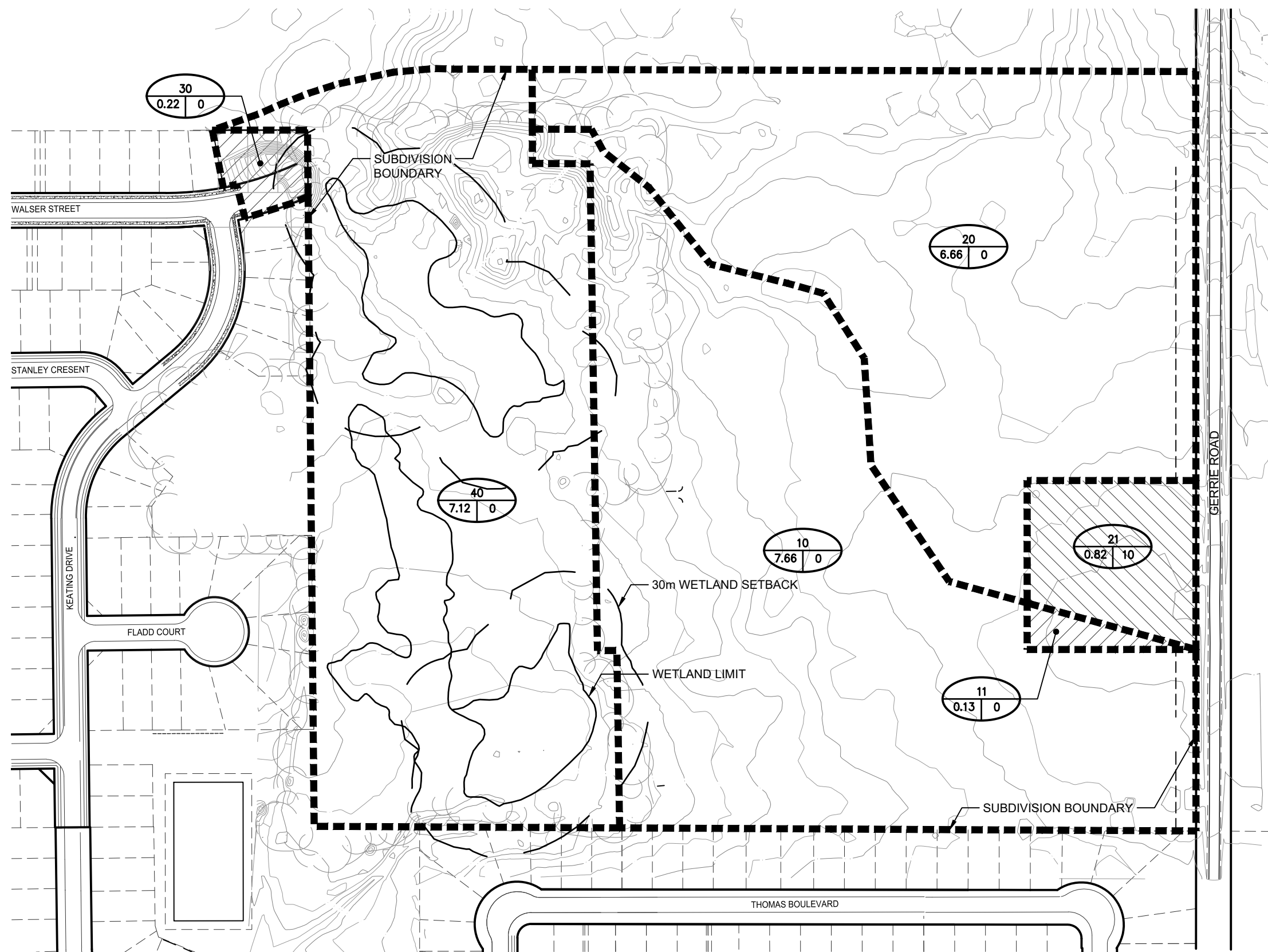

Table No. 3 summarizes the existing condition flow rates and runoff volumes from the site for the full range of design storm events.

Table No. 3: Existing Condition Flow Rates and Runoff Volumes

	CATCHMENTS									
	30	Total to Walsler	10	11	40	Total to Ex. Wetland	20	21	Total to Tributary of Grand River	Total from Site
2-Year										
Flow Rate (m ³ /s)	0.003	0.003	0.044	0.001	0.060	0.101	0.038	0.016	0.043	0.143
Runoff Volume (m ³)	11.3	11.3	397.3	6.7	364.5	779.7	340.5	60.4	400.9	1,180.5
5-Year										
Flow Rate (m ³ /s)	0.009	0.009	0.157	0.004	0.209	0.358	0.135	0.030	0.152	0.510
Runoff Volume (m ³)	28.2	28.2	995.9	16.7	913.0	1,953.8	853.4	130.5	983.9	2,937.7
10-Year										
Flow Rate (m ³ /s)	0.015	0.015	0.273	0.008	0.359	0.517	0.234	0.049	0.263	0.828
Runoff Volume (m ³)	42.6	42.6	1,505.1	25.2	1,380.7	2,759.8	1,289.8	188.3	1,478.1	4,431.8
25-Year										
Flow Rate (m ³ /s)	0.024	0.024	0.454	0.012	0.584	1.015	0.389	0.078	0.435	1.447
Runoff Volume (m ³)	62.5	62.5	2,210.7	37.0	2,027.3	4,337.4	1,894.4	266.6	2,161.0	6,498.4
50-Year										
Flow Rate (m ³ /s)	0.032	0.032	0.618	0.016	0.789	1.359	0.530	0.103	0.592	1.948
Runoff Volume (m ³)	79.6	79.6	2,811.2	47.1	2,577.4	5,515.2	2,409.1	332.7	2,741.8	8,257.0
100-Year										
Flow Rate (m ³ /s)	0.039	0.039	0.801	0.020	0.985	1.746	0.687	0.134	0.763	2.495
Runoff Volume (m ³)	97.5	97.5	3,447.0	57.6	3,160.5	6,762.6	2,953.9	401.7	3,355.6	10,118.2
Regional										
Flow Rate (m ³ /s)	0.024	0.024	0.881	0.014	0.772	1.688	0.755	0.087	0.840	2.528
Runoff Volume (m ³)	447.0	447.0	15,780.0	267.9	14,536.0	30,583.9	13,523.0	1,719.5	15,242.5	46,273.5

Table No. 4 gives the results of the ponding in the existing wetland.

Table No. 4: Wetland (Stage/Storage/Discharge)

	Available Capacity			Actual Capacity Used			Drawdown Time (hr)**
	Peak Flow m ³ /s	Storage Volume m ³	Storage Elevation m	Peak Flow m ³ /s	Storage Volume m ³	Storage Elevation m	
Wetland Bottom	0.000	0.0	409.63	---	---	---	---
2-Year	---	---	---	0.089	54	409.65	9.3
5-Year	---	---	---	0.324	197	409.69	5.6
10-Year	---	---	---	0.549	333	409.73	5.6
25-Year	---	---	---	0.886	539	409.77	5.5
50-Year	---	---	---	1.185	724	409.79	5.4
100-Year	---	---	---	1.513	924	409.82	5.4
Regional Storm	---	---	---	1.612	1,012	409.83	52.0
Overflow	18.965	15,227.7	410.75	---	---	---	---

**Drawdown time obtained from the hydrologic modelling software MIDUSS

Table No. 5 gives the results of the existing condition drainage channel routing downstream of the existing wetland.

Table No. 5: Wetland (Existing Condition Drainage Channel Downstream of Wetland – Section 1 of 2)

	Channel Design Capacity			Actual Channel Capacity Used		
	Peak Flow m ³ /s	Average Channel Depth m	Velocity m/s	Peak Flow m ³ /s	Average Channel Depth m	Velocity m/s
2-Year	---	---	---	0.089	0.158	0.532
5-Year	---	---	---	0.324	0.256	0.735
10-Year	---	---	---	0.549	0.312	0.839
25-Year	---	---	---	0.886	0.374	0.946
50-Year	---	---	---	1.183	0.417	1.016
100-Year	---	---	---	1.507	0.456	1.080
Regional Storm	---	---	---	1.612	0.468	1.098
Top of Bank	10.655	0.95	1.602	---	---	---

Table No. 6 gives the results of the existing condition drainage channel routing downstream of the existing wetland.

Table No. 6: Wetland (Existing Condition Drainage Channel Downstream of Wetland – Section 2 of 2)

	Channel Design Capacity			Actual Channel Capacity Used		
	Peak Flow m ³ /s	Average Channel Depth m	Velocity m/s	Peak Flow m ³ /s	Average Channel Depth m	Velocity m/s
2-Year	---	---	---	0.089	0.080	0.500
5-Year	---	---	---	0.323	0.167	0.774
10-Year	---	---	---	0.549	0.312	0.839
25-Year	---	---	---	0.880	0.291	1.055
50-Year	---	---	---	1.180	0.341	1.150
100-Year	---	---	---	1.499	0.386	1.232
Regional Storm	---	---	---	1.606	0.401	1.256
Top of Bank	9.246	0.95	1.966	---	---	---

b) Proposed Release Rates

In order to maintain the existing condition drainage pattern to the existing wetland and Grand River tributary, the release rates have been determined by the existing condition release rates. Under post-development conditions, runoff generated from the site will be attenuated to the existing condition levels conveyed to the existing wetland and the Grand River tributary.

The release rate to Walser Street under minor storm design events is determined by the capacity of the existing storm sewers in Ville Lora Downs North Subdivision Phase III, which were designed to incorporate a small contributing area from Walser Street. The capacity of the existing 300mm diameter storm sewer conveying a portion of the proposed development is approximately 0.110m³/s, based on a grade of 1.34%. Excluding the existing contributing area to this storm sewer (0.05ha), the proposed development's allotment of the pipe's capacity is 0.106m³/s. The allowable to Walser Street under major storm events has been determined based on the allotted area of 0.65ha, as per the Villa Lora Downs North Phase III storm drainage area plans.

Therefore, the proposed release rates from the site under post-development conditions are outlined in Table No. 7.

Table No. 7: Proposed Release Rates

Release Route	2-Year	5-Year	10-Year	25-Year	50-Year	100-Year	Regional
To Ex. Wetland	0.093m ³ /s	0.331m ³ /s	0.517m ³ /s	0.940m ³ /s	1.261m ³ /s	1.614m ³ /s	1.582m ³ /s
To Tributary of Grand River	0.043m ³ /s	0.152m ³ /s	0.263m ³ /s	0.435m ³ /s	0.592m ³ /s	0.763m ³ /s	0.840m ³ /s
To Walser Street	0.106m ³ /s		0.122m ³ /s	0.150m ³ /s	0.173m ³ /s	0.196m ³ /s	0.080m ³ /s

c) Post-Development Conditions

Under post-development conditions, the existing drainage patterns of the site will be maintained. Post-development flows from the site will be attenuated to existing condition levels through the use of two (2) stormwater management facilities. Stormwater Management Facility No. 1 will outlet to the existing wetland. Stormwater Management Facility No. 2 will outlet to the existing roadside ditch along Gerrie Road and ultimately a tributary of the Grand River.

For the post-development condition analysis, the 21.46-hectare site and 1.24 hectares of external areas was modelled as fourteen (14) drainage catchments. These catchments are shown on the Post-Development Storm Drainage Area Plan (Figure No. 4).

Catchment 1000 (6.76-hectares, 50% Impervious) represents the southwest portion of development, including Street No. 3, Street No. 4, and a portion of Street No. 2. Major and minor storm runoff generated from Catchment 1000 will be directed to Stormwater Management Facility No. 1.

Catchment 1100 (0.48-hectares, 0% Impervious) represents a portion of external lands including existing residential lot. Major and minor storm runoff generated from Catchment 1100 will be directed to Stormwater Management Facility No. 1.

Catchment 1200 (0.22-hectares, 50% Impervious) represents the rear yards of lots 50-57. Runoff generated from Catchment 1200 will be directed to Infiltration Gallery No. 1.

Catchment 1300 (0.84-hectares, 50% Impervious) represents the rear yards of lots 68-81. Runoff generated from Catchment 1300 will be directed to Infiltration Gallery No. 1.

Catchment 1400 (0.62-hectares, 20% Impervious) represents the park block. Runoff generated from Catchment 1400 will be directed to Infiltration Gallery No. 2. The clear stone infiltration gallery (80m L x 10m W x 0.70m D) with two (2) 300mm diameter perforated pipes which run the length of the gallery will provide approximately 192 m³ of storage. The clear stone infiltration gallery has been designed with sufficient capacity to infiltrate minor storm runoff generated by Catchment 1400. Flows exceeding the capacity of the clear stone infiltration gallery will be directed to Stormwater Management Facility No. 1.

Catchment 1500 (1.11-hectares, 50% Impervious) represents a portion of Walser Street and Street No. 1. Minor runoff generated from Catchment 1500 will be conveyed via storm sewers to Stormwater Management Facility No. 1, ultimately discharging to the existing wetland. Major runoff generated from Catchment 1500 will sheetflow uncontrolled to the existing wetland.

Quality control treatment (80% TSS removal) for runoff generated from Catchment 1000, 1100, 1400, and 1500 will be provided by three (3) oil/grit separator structures. The first oil/grit separator structure (Stormceptor STC 6000 or approved equivalent) will be located north of the northerly inlet to Stormwater Management Facility No. 1 (Street 3). The second oil/grit separator structure (Stormceptor STC 4000 or approved equivalent) will be located south of the northerly inlet to Stormwater Management Facility No. 1 (Street 4). The third oil/grit separator structure (Stormceptor STC 3000 or approved equivalent) will be located at the southerly inlet to Stormwater Management Facility No. 1 (Street 1).

Catchment 1600 (0.36-hectares, 50% Impervious) represents the rear yards of lots 58-67. Runoff generated from Catchment 1600 will be directed to Infiltration Gallery No. 1. The clear stone infiltration gallery (145m L x 3.5-5m W x 0.87m D), receiving flows from Catchments 1200, 1300, and 1600 with four to six (4 to 6) 600mm diameter perforated pipes which run the length of the gallery will provide approximately 301.1 m³ of storage. Flows exceeding the capacity of the clear stone infiltration gallery will be directed to Stormwater Management Facility No. 1.

411009
 AINLEY FARM
 SUBDIVISION
 TOWNSHIP OF CENTRE
 WELLINGTON (ELORA)

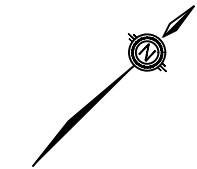

LEGEND

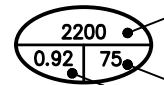
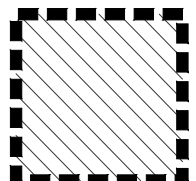
-  DRAINAGE AREA BOUNDARY
-  CATCHMENT NUMBER
% IMPERVIOUS AREA IN HECTARES
-  EXTERNAL LANDS

POST DEVELOPMENT
 STORM DRAINAGE
 AREA PLAN

FIGURE No. 4

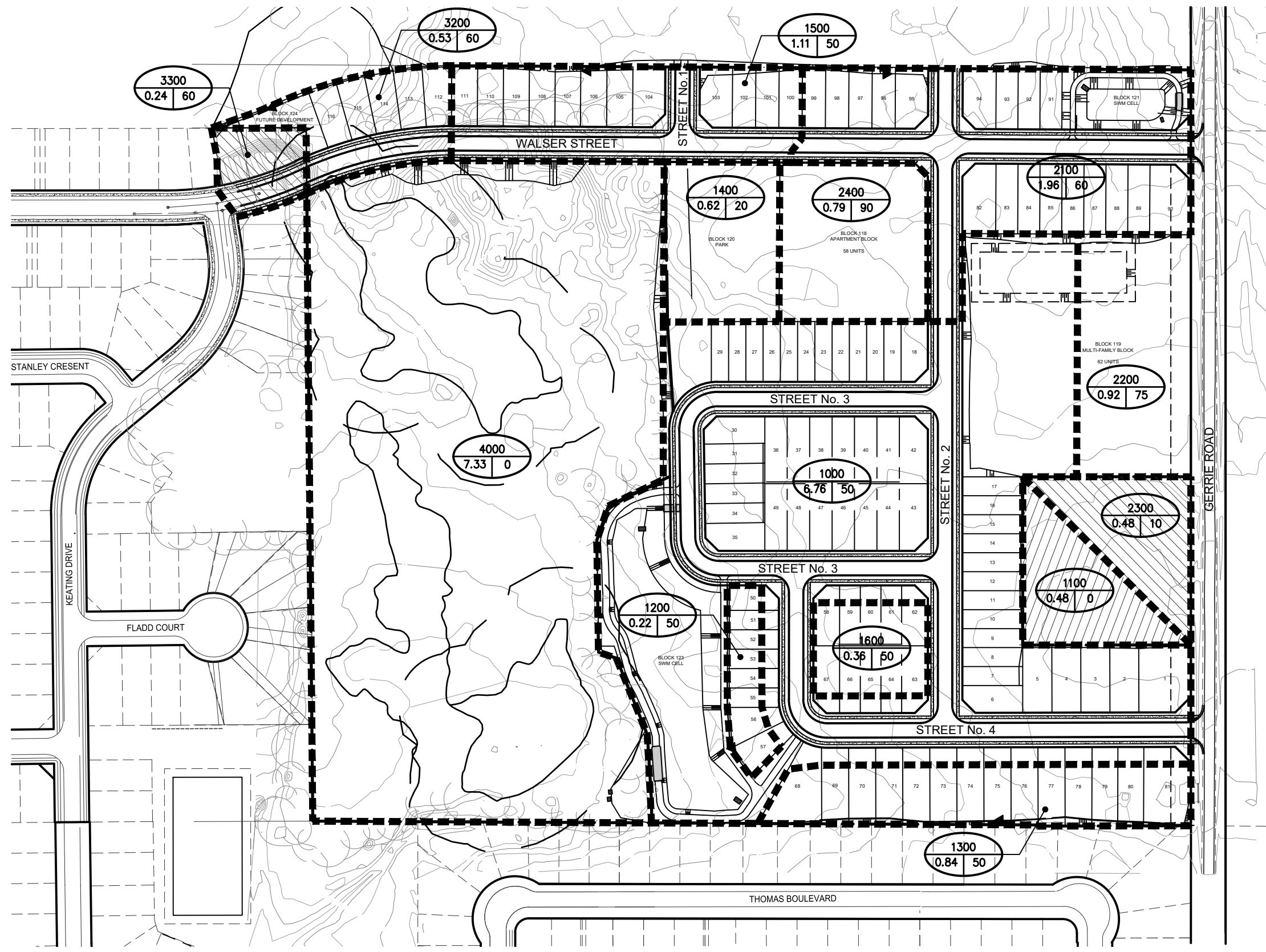

Stormwater Management Facility No. 1 has been designed as a dry pond with approximately 5,464 m³ of storage. Discharging from this pond will be via a multi-stage outlet consisting of a 150 mm knockout for minor storms and a 350mm diameter orifice for major storms, as well as a 20 m wide overflow weir.

Catchment 2100 (1.96-hectares, 60% Impervious) represents the north portion of development, including the remainder of Street 2, and a portion of Walser Street. Major and minor storm runoff generated from Catchment 2100 will be directed to Stormwater Management Facility No. 2, ultimately discharging to a tributary of the Grand River via the existing roadside ditch along Gerrie Road.

Catchment 2200 (0.92-hectares, 75% Impervious) represents the a portion of the multi-family residential block. Runoff generated from Catchment 2200 will discharge to the roadside ditch along Gerrie Road, and ultimately a tributary of the Grand River. At such time as development of Catchment 2200 proceeds, a privately owned and operated on-site quality and quantity control stormwater management facility will be required to attenuate stormwater runoff to the existing condition level, prior to discharge to the existing roadside ditch along Gerrie Road.

The privately owned and operated on-site stormwater management facility will be designed, reviewed and approved as part of the site plan approval process for the development block. The on-site stormwater management controls which may be utilized include, but are not limited to, a stormwater management facility (i.e. SWM pond), rooftop storage, parking lot ponding (to a maximum depth of 0.3m), below grade storage (i.e. clear stone storage, superpipe storage, etc.) and oil/grit separators. A preliminary stormwater management facility with approximately 2,085 m³ of storage has been modelled to provide attenuation levels for the post-development runoff generated by Catchment 2200.

Catchment 2300 (0.48-hectares, 10% Impervious) represents the remainder of the existing residential lot on Gerrie Road. Major and minor storm runoff generated from Catchment 2300 will be directed to the existing roadside ditch on Gerrie Road, ultimately discharging to a tributary of the Grand River.

Catchment 2400 (0.79-hectares, 90% Impervious) represents the apartment block. Runoff generated from Catchment 2400 will be directed to Stormwater Management Facility No. 2, ultimately discharging to a tributary of the Grand River via the existing roadside ditch along Gerrie Road.

Stormwater Management Facility No. 2 has been designed as a dry pond with approximately 1,741 m³ of storage. Discharging from this pond will be via a multi-stage outlet consisting of a 150 mm knockout for minor storms and a 300mm diameter orifice for major storms, as well as a 10 m wide overflow weir.

Quality control treatment (80% TSS removal) for runoff generated from Catchment 2100 and 2400 will be provided by one (1) oil/grit separator structure. The oil/grit separator structure (Stormceptor STC 6000 or approved equivalent) will be located at the inlet to Stormwater Management Facility No. 2.

Catchment 3200 (0.53-hectares, 60% Impervious) represents five (5) new single family lots and a portion of Walser Street that form part of the Ville Lora Downs North Phase III development. Minor storm runoff generated from Catchment 3200 will be directed to the existing storm sewers on Walser Street. Major storm runoff generated from Catchment 3200 will sheetflow overland to the existing Walser Street right-of-way.

Catchment 3300 (0.24-hectares, 60% Impervious) represents three (3) new single family lots and a portion of Walser Street that form part of the Ville Lora Downs North Phase III development. Minor storm runoff generated from Catchment 3300 will be directed to the existing storm sewers on Walser Street. Major storm runoff generated from Catchment 3300 will discharge overland to the existing Walser Street right-of-way.

Quality and quantity control for stormwater runoff generated from Catchments 3200 and 3300 will be provided by the existing stormwater management facilities approved and constructed as part of the Villa Lora Downs North Phase II development.

Catchment 4000 (7.33 hectares, 0% impervious) represents the remainder of the site, which is a natural heritage feature consisting of a woodlot and wetland area. Runoff generated from Catchment 4000 will continue to sheetflow overland, ultimately discharging to the existing swale in Drimmie Park and the existing storm sewers on Keating Drive.

Table No. 8 lists the uncontrolled flow rate and runoff volumes generated from each catchment area shown on Figure No. 4, for the 2, 5, 10, 25, 50 and 100-year design storm events and the Regional storm.

Table No. 8: Post-Development Uncontrolled Flow Rate and Runoff Volume

	CATCHMENTS																
	1000	1100	1200	1300	1400	1500	1600	4000	To Ex. Wetland	2100	2200	2300	2400	To Roadside Ditch	3200	3300	To Walser Street
2-Year																	
Flow Rate (m ³ /s)	0.641	0.009	0.021	0.076	0.024	0.105	0.033	0.001	0.899	0.223	0.130	0.011	0.127	0.488	0.057	0.026	0.083
Runoff Volume (m ³)	1,175.5	32.9	37.6	144.9	68.2	190.9	62.0	16.2	1,728.2	377.7	205.8	42.8	202.0	828.3	102.4	46.4	148.8
5-Year																	
Flow Rate (m ³ /s)	0.905	0.028	0.029	0.111	0.038	0.146	0.048	0.019	1.288	0.304	0.176	0.030	0.175	0.676	0.082	0.037	0.119
Runoff Volume (m ³)	2,031.5	76.2	65.1	251.4	133.2	330.9	107.5	156.6	3,152.3	638.8	338.3	89.7	325.2	1,392.0	173.5	78.6	252.1
10-Year																	
Flow Rate (m ³ /s)	1.059	0.043	0.037	0.137	0.056	0.174	0.060	0.050	1.538	0.359	0.206	0.045	0.205	0.802	0.099	0.045	0.144
Runoff Volume (m ³)	2,665.0	111.7	85.4	330.0	184.0	434.9	141.1	326.8	4,278.9	830.1	433.4	127.0	411.7	1,802.2	225.2	102.0	327.2
25-Year																	
Flow Rate (m ³ /s)	1.251	0.065	0.047	0.173	0.082	0.213	0.076	0.114	1.870	0.435	0.245	0.067	0.242	0.972	0.122	0.055	0.178
Runoff Volume (m ³)	3,471	160.0	111.3	430.8	251.3	568.2	183.8	606.6	5,783.0	1,073.0	552.8	177.2	518.7	2,321.7	290.9	131.7	422.6
50-Year																	
Flow Rate (m ³ /s)	1.406	0.082	0.055	0.203	0.105	0.242	0.089	0.183	2.147	0.491	0.275	0.086	0.270	1.103	0.141	0.064	0.205
Runoff Volume (m ³)	4,119.0	200.4	132.0	512.1	306.8	675.6	218.5	874.1	7,038.3	1,267.8	647.8	218.8	603.0	2,737.4	343.5	155.5	499.0
100-Year																	
Flow Rate (m ³ /s)	1.559	0.101	0.063	0.233	0.129	0.277	0.102	0.268	2.433	0.554	0.306	0.105	0.297	1.241	0.160	0.072	0.232
Runoff Volume (m ³)	4,779.0	242.1	152.9	594.6	363.6	785.9	253.9	1,180.1	8,352.2	1,466.7	744.1	261.6	687.8	3,160.3	396.7	179.7	576.4
Regional Storm																	
Flow Rate (m ³ /s)	0.744	0.055	0.027	0.102	0.071	0.129	0.044	0.619	1.676	0.232	0.112	0.055	0.100	0.500	0.065	0.029	0.094
Runoff Volume (m ³)	15,873.0	1031.7	490.7	1,915.0	1,379.9	2,555.4	811.9	9,470.4	33,528.3	4,559.9	2,173.8	1,044.2	1,883.5	9,661.4	1,222.1	553.4	1,775.5

d) Routing

Table No. 9 compares the routing results through the proposed Infiltration Gallery No. 1.

Table No. 9: Catchment 1200, 1300 & 1600 – Infiltration Gallery No. 1 Available Stage/Storage/Discharge

CONTROL	Available Capacity			Actual Capacity Used		
	Peak Flow m ³ /s	Storage Volume m ³	Storage Elevation m	Peak Flow m ³ /s	Storage Volume m ³	Storage Elevation m
Bottom of Stone	0.000	0.0	411.83	---	---	---
2-Year	---	---	---	0.000	240.5	412.47
Top of Stone	0.000	301.1	412.70	---	---	---
CB Lip (1)	0.000	301.4	413.23	---	---	---
5-Year	---	---	---	0.045	301.8	413.45
10-Year	---	---	---	0.127	302.6	413.66
25-Year	---	---	---	0.254	303.5	413.85
50-Year	---	---	---	0.313	304.2	413.95
100-Year	---	---	---	0.378	304.8	414.04
Regional Storm	---	---	---	0.173	302.8	413.70
CB Lip (2)	0.433	305.2	414.09	---	---	---
Overflow	0.919	309.6	414.49	---	---	---

Table No. 10 compares the routing results through the proposed Infiltration Gallery No. 2.

Table No. 10: Catchment 1400 – Infiltration Gallery No. 2 Available Stage/Storage/Discharge

CONTROL	Available Capacity			Actual Capacity Used		
	Peak Flow m ³ /s	Storage Volume m ³	Storage Elevation m	Peak Flow m ³ /s	Storage Volume m ³	Storage Elevation m
Bottom of Stone	0.000	0.0	413.92	---	---	---
2-Year	---	---	---	0.001	54.7	414.12
5-Year	---	---	---	0.001	123.5	414.37
10-Year	---	---	---	0.001	138.5	414.42
Top of Stone	0.001	191.8	414.62	---	---	---
Pipe Invert	0.001	191.8	414.72	---	---	---
25-Year	---	---	---	0.017	191.9	414.83
50-Year	---	---	---	0.046	192.2	415.12
Top of Grate	0.053	192.1	415.12	---	---	---
Regional Storm	---	---	---	0.070	192.9	415.13
100-Year	---	---	---	0.090	193.7	415.14
Weir	1.244	304.7	415.42	---	---	---

Table No. 11 compares the routing results through the proposed Stormwater Management Facility No. 1.

Table No. 11: Catchment 1000, 1100, 1200, 1300, 1400, 1500 (minor) & 1600 – Stormwater Management Facility No. 1 Available Stage/Storage/Discharge

CONTROL	Available Capacity			Actual Capacity Used		
	Peak Flow m ³ /s	Storage Volume m ³	Storage Elevation m	Peak Flow m ³ /s	Storage Volume m ³	Storage Elevation m
CB Lip 1 Elevation	0.00	0.0	411.00	---	---	---
2-Year	---	---	---	0.089	802.9	411.17
5-Year	---	---	---	0.124	1,636.3	411.33
CB Lip 2 Elevation	0.133	1,994.3	411.40	---	---	---
10-Year	---	---	---	0.214	2,228.2	411.44
25-Year	---	---	---	0.337	2,841.1	411.55
50-Year	---	---	---	0.368	3,461.1	411.66
100-Year	---	---	---	0.399	4,174.8	411.79
Weir	0.415	4,554.3	411.85	---	---	---
Regional Storm	---	---	---	1.028	4,908.1	411.91
Top of Bank	2.088	5,463.6	412.00	---	---	---

Table No. 12 gives the results of the post-development condition of the existing wetland.

Table No. 12: Wetland Available Stage/Storage/Discharge

CONTROL	Available Capacity			Actual Capacity Used			Drawdown Time (hr)**
	Peak Flow m ³ /s	Storage Volume m ³	Storage Elevation m	Peak Flow m ³ /s	Storage Volume m ³	Storage Elevation m	
Wetland Bottom	0.000	0.0	409.63	---	---	---	---
2-Year	---	---	---	0.089	54.3	409.65	9.3
5-Year	---	---	---	0.142	86.7	409.66	11.4
10-Year	---	---	---	0.256	156.2	409.68	12.5
25-Year	---	---	---	0.437	266.7	409.71	12.9
50-Year	---	---	---	0.525	317.7	409.73	13.3
100-Year	---	---	---	0.633	383.7	409.74	13.8
Regional Storm	---	---	---	1.555	1,016.4	409.83	60.0
Overflow	18.965	15,227.7	410.75	---	---	---	---

Table No. 13 gives the results of the post-development condition drainage channel routing downstream of the existing wetland.

Table No. 13: Wetland (Post-Development Condition Drainage Channel Downstream of Wetland – Section 1 of 2)

	Channel Design Capacity			Actual Channel Capacity Used		
	Peak Flow m ³ /s	Average Channel Depth m	Velocity m/s	Peak Flow m ³ /s	Average Channel Depth m	Velocity m/s
2-Year	---	---	---	0.089	0.158	0.532
5-Year	---	---	---	0.142	0.188	0.598
10-Year	---	---	---	0.256	0.235	0.693
25-Year	---	---	---	0.437	0.287	0.792
50-Year	---	---	---	0.525	0.307	0.830
100-Year	---	---	---	0.633	0.330	0.869
Regional Storm	---	---	---	1.555	0.462	1.088
Top of Bank	10.655	0.95	1.602	---	---	---

Table No. 14 gives the results of the post-development condition drainage channel routing downstream of the existing wetland.

Table No. 14: Wetland (Post-Development Condition Drainage Channel Downstream of Wetland – Section 2 of 2)

	Channel Design Capacity			Actual Channel Capacity Used		
	Peak Flow m ³ /s	Average Channel Depth m	Velocity m/s	Peak Flow m ³ /s	Average Channel Depth m	Velocity m/s
2-Year	---	---	---	0.089	0.080	0.500
5-Year	---	---	---	0.142	0.104	0.589
10-Year	---	---	---	0.256	0.146	0.718
25-Year	---	---	---	0.437	0.198	0.852
50-Year	---	---	---	0.524	0.219	0.902
100-Year	---	---	---	0.632	0.243	0.955
Regional Storm	---	---	---	1.546	0.393	1.243
Top of Bank	9.246	0.950	1.966	---	---	---

Table No. 15 compares the routing results through the proposed Stormwater Management Facility No. 2.

Table No. 15: Catchment 2100, 2400 – Stormwater Management Facility No. 2 Available Stage/Storage/Discharge

CONTROL	Available Capacity			Actual Capacity Used		
	Peak Flow m ³ /s	Storage Volume m ³	Storage Elevation m	Peak Flow m ³ /s	Storage Volume m ³	Storage Elevation m
120mm Knockout	0.00	0.0	410.65	---	---	---
2-Year	---	---	---	0.027	397.2	411.06
CB Lip Elevation	0.029	439.4	411.10	---	---	---
5-Year	---	---	---	0.119	549.3	411.19
10-Year	---	---	---	0.139	691.0	411.30
25-Year	---	---	---	0.158	910.4	411.46
50-Year	---	---	---	0.171	1,094.5	411.58
Weir	0.178	1,201.7	411.65	---	---	---
Regional Storm	---	---	---	0.268	1,222.6	411.66
100-Year	---	---	---	0.289	1,227.0	411.66
Top of bank	2.575	1,741.7	411.95	---	---	---

Table No. 16 summarizes the post-development flow rates from the site.

Table No. 16: Summary of Post-Development Flow Rates and Runoff Volumes from the Site

	CATCHMENTS										
	1000, 1100, 1200, 1300, 1400, 1500 (minor), 1600 (controlled)	1500 (major) (uncontrolled)	4000 (uncontrolled)	To Ex. Wetland	2100, 2400 (controlled)	2200 (controlled)	2300 (uncontrolled)	To Roadside Ditch	3200 (uncontrolled)	3300 (uncontrolled)	To Walsler Street
2-Year											
Flow Rate (m ³ /s)	0.089	0.000	0.001	0.089	0.027	0.008	0.011	0.043	0.061	0.026	0.087
Runoff Volume (m ³)	1,399.2	0.0	16.2	1,415.4	579.7	205.8	42.8	828.3	101.7	46.4	148.1
5-Year											
Flow Rate (m ³ /s)	0.124	0.000	0.019	0.142	0.119	0.012	0.030	0.149	0.084	0.037	0.121
Runoff Volume (m ³)	2,799.3	0.0	156.6	2,955.9	964.0	338.3	89.7	1,392.0	172.5	78.6	251.1
10-Year											
Flow Rate (m ³ /s)	0.213	0.028	0.050	0.263	0.139	0.014	0.045	0.189	0.098	0.045	0.143
Runoff Volume (m ³)	3,686.0	10.7	326.8	4,023.5	1,241.8	433.4	127.0	1802.2	224.1	102.0	326.1
25-Year											
Flow Rate (m ³ /s)	0.337	0.067	0.114	0.449	0.158	0.026	0.067	0.225	0.115	0.055	0.170
Runoff Volume (m ³)	4,898.9	46.1	606.6	5,551.6	1,591.7	552.8	177.2	2,321.7	288.9	131.7	420.6
50-Year											
Flow Rate (m ³ /s)	0.368	0.096	0.183	0.543	0.171	0.058	0.086	0.260	0.129	0.064	0.193
Runoff Volume (m ³)	5,795.6	90.8	874.1	6,760.5	1,870.8	647.8	218.8	2,737.4	341.6	155.5	497.1
100-Year											
Flow Rate (m ³ /s)	0.401	0.131	0.268	0.653	0.289	0.093	0.105	0.431	0.144	0.072	0.217
Runoff Volume (m ³)	6,819.0	145.5	1,180.1	8,144.6	2,154.5	744.1	261.6	3,160.2	395.1	179.7	574.8
Regional Storm											
Flow Rate (m ³ /s)	1.058	0.000	0.619	1.677	0.268	0.096	0.055	0.406	0.062	0.029	0.091
Runoff Volume (m ³)	23,614.6	0.0	9,470.4	33,085.0	6,443.4	2,173.8	1,044.2	9,661.4	1,238.7	553.4	1,792.1

The following table compares the proposed release rates to the post-development flow rates for the site.

Table No. 17: Comparison of Release Rates and Post-Development Conditions Flow Rates

DESIGN STORM	To Ex. Wetland		To Tributary of Grand River		To Walsler Street	
	Proposed Release Rate (m ³ /s)	Post Flow Rate (m ³ /s)	Proposed Release Rate (m ³ /s)	Post Flow Rate (m ³ /s)	Proposed Release Rate (m ³ /s)	Post Flow Rate (m ³ /s)
2 Year	0.093	0.090	0.043	0.043	0.106	0.087
5 Year	0.331	0.142	0.152	0.149		0.121
10 Year	0.517	0.263	0.263	0.189	0.122	0.143
25 Year	0.940	0.449	0.435	0.225	0.150	0.170
50 Year	1.261	0.543	0.592	0.260	0.173	0.193
100 Year	1.614	0.671	0.763	0.431	0.196	0.217
Regional	1.582	1.674	0.840	0.406	0.080	0.094

Therefore, the post-development runoff generated from the site will be attenuated to the less than the proposed release rates to the existing wetland and to the Grand River tributary. Minor runoff generated from the site and conveyed to existing storm sewers on Walsler Street is within 15% of the previously identified release rate. Based on our review of the flow rates, surcharged hydraulic grade lines, and storm sewer depth along Walsler Street, the surcharge during the 5-year design storm event is minimal and is contained below ground. Therefore, in our opinion the existing storm sewer on Walsler Street has capacity to convey the proposed 5-year post-development flow rates. In addition, major stormwater flows to Walsler Street exceed the release rate included in the Ville Lora Downs Subdivision by approximately 0.020m³/s under the major design storm events, equivalent to a 35% increase in contributing area. The increased runoff under major storms is minimal enough to be conveyed within the Walsler Street and Keating Drive right-of-way.

5.3.4 MINOR / MAJOR DRAINAGE SYSTEM

Minor storm drainage will be conveyed to the proposed stormwater management facilities and the existing storm sewers on Walsler Street via storm sewers with the capacity to convey the 5-year design storm event.

The major storm runoff generated from Street 1, and a portion of Street 2, Street 3 and Street 4 will discharge to the proposed stormwater management facility located east of the existing wetland (Stormwater Management Facility No. 1), which outlets to the existing wetland, ultimately discharging to the existing storm sewers on Keating Drive.

The major storm runoff generated from the remainder of Street 2 and a portion of the Walsler Street extension will discharge to the proposed stormwater management facility (Stormwater Management Facility No. 2), ultimately discharging to a tributary of the Grand River.

The major storm runoff generated from the remainder of the Walsler Street extension will discharge directly to the existing Walsler Street Right-of-Way, ultimately discharging to the Keating Drive Right-of-Way.

Preliminary analysis indicates that the municipal right-of-way has the capacity to convey the runoff from a major design storm event.

The major design storm drainage patterns expected for the Ainley Farm Subdivision are shown on Figure 5.

411009
 AINLEY FARM
 SUBDIVISION
 TOWNSHIP OF CENTRE
 WELLINGTON (ELORA)

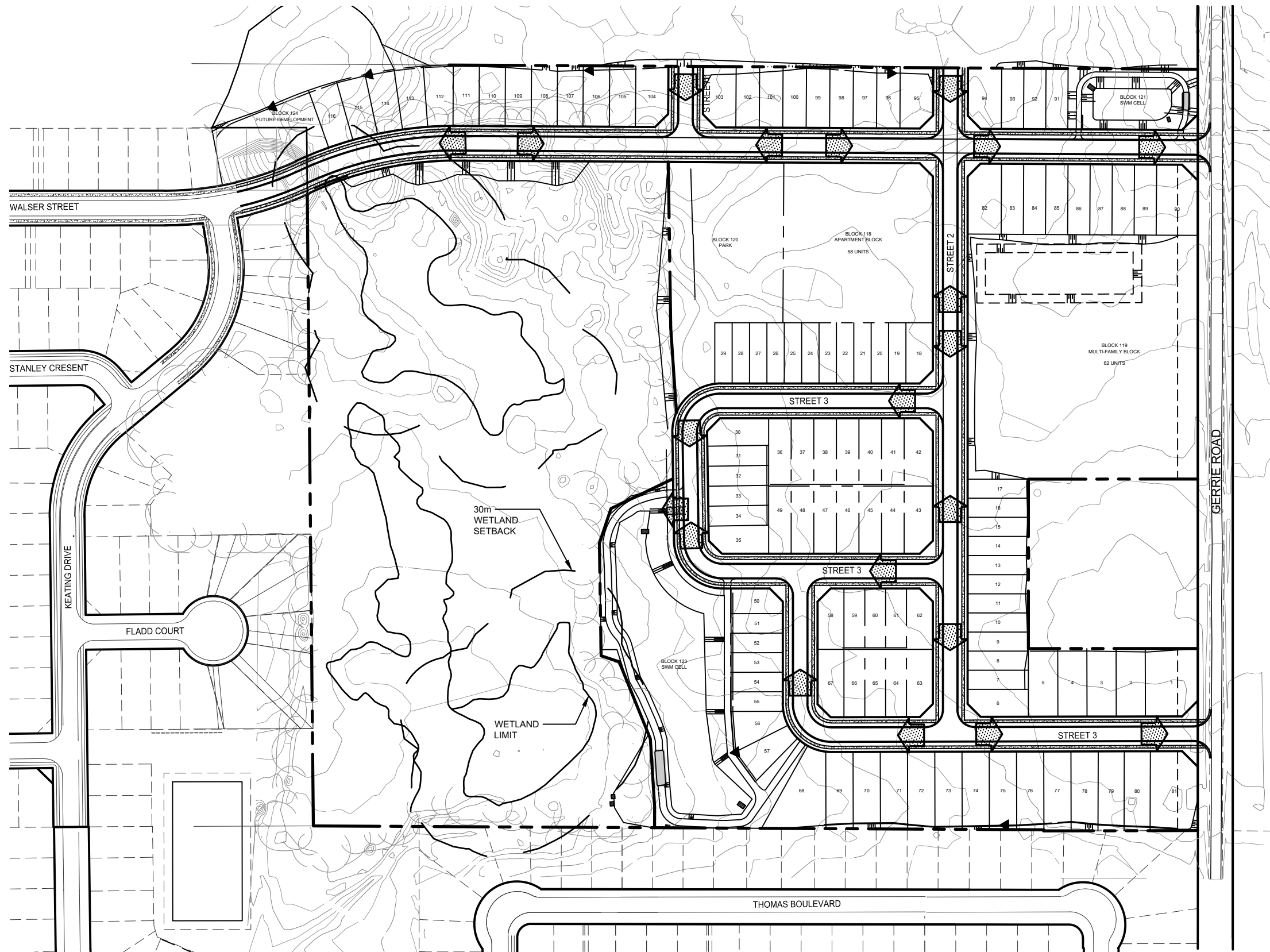

LEGEND

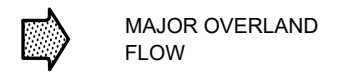

MAJOR STORM
 DRAINAGE PATTERN
 PLAN

FIGURE No. 5



5.4 WATER BUDGET

The average annual precipitation for the site is estimated to be 945.9 mm. This amount is based on precipitation data recorded at the Fergus Shand Dam meteorological station for the period from 1981 to 2010.

From the Preliminary Geotechnical Investigation (CMT Engineering Inc., March 26, 2006), the surficial deposits across the majority of the site are described as native silt tills, with some sandy silt tills. As there are no areas of consistent sandy soils across the site, the characteristics of the silt tills will be used to develop the water budget analysis across the site.

The potential for evapotranspiration for this area is estimated to be 557.8 mm for the pervious surfaces. Therefore, 388.1 mm remain available for infiltration and runoff from the silt till.

Per Table 3.1 of the Stormwater Management Planning and Design Manual (Ministry of Environment, dated 2003), a silt till, which acts similar to clay (hence the low conductivity values), in flat cultivated land has an approximate infiltration rate of 87 mm/yr. Therefore, the runoff is estimated to be 301.1 mm/yr.

Based on the annual infiltration rates, the existing annual average groundwater recharge occurring within the 21.46-hectare site, and 1.24 hectares of external areas discharging to the site, is estimated to be 12,719 m³. Under post-development conditions, the annual average groundwater recharge occurring on-site and within the external areas naturally is estimated to be 5,492 m³. The additional annual recharge that will occur on-site via the two (2) proposed infiltration galleries is estimated to be 7,438 m³, resulting in a total post-development annual recharge rate of 12,930 m³. Therefore, the infiltration rates from existing conditions have been maintained under post-development conditions via two (2) infiltration galleries.

Under existing conditions, the annual average runoff from the site and external areas is estimated to be 68,350 m³. As a result of the proposed development the impervious area (rooftop and paved surfaces) of the site increases, the annual potential evapotranspiration for impervious surfaces decreases to 200 mm and the runoff from the site increases. The runoff from the site and external areas under post-development conditions is estimated to be 97,261 m³ per year.

The estimated existing and post-development recharge and runoff volumes for the Ainley Farm Subdivision are detailed in Table No. 18. The estimations take into account the surficial geology, which is comprised mainly of glacial tills. The net recharge values are for the uppermost overburden aquifer. The water budget analysis has been included in Appendix D.

Table No. 18: Summary of Recharge and Runoff Volume

	Existing Condition	Post-Development Condition	Percent Change
Total Estimated Recharge	12,719 m ³	12,930 m ³	+1.7%
Total Estimated Runoff	68,350 m ³	97,261 m ³	+42.3%

6.0 SEDIMENT AND EROSION CONTROL PLAN

A silt fence will be installed along the property boundary. The silt fence will serve to minimize the opportunity for water borne sediments to be transported from the site to the adjacent properties.

Temporary straw bale check dams will be installed in rear yard swales after the initial grading has been completed to slow the flow rates and promote the settlement of water borne sediments before they reach the silt fences and stormwater management facilities.

Upon completion of the grading, any area not subject to active construction within 30 days will be top soiled and seeded as per OPSS 572.

Once catch basins have been installed, the grates will be wrapped in filter cloth. This feature will be maintained until all building and landscaping has been completed.

Inspection and maintenance of all silt fencing and sediment and erosion controls will start after installation is complete. These features will be inspected on a weekly basis or after a rainfall event of 13 mm or greater. Maintenance will be carried out, within 48 hours, on any part of the controls found to need repair.

Once construction and landscaping within the limits of the subdivision has been substantially completed (75% house building construction is complete), the silt fence will be removed, any accumulated sediment will be collected, and the area will be restored.

After construction of the subdivision, erosion and sediment transport will be minimal.

7.0 MAINTENANCE PLAN

A two-phase maintenance plan is recommended. Phase I will address the short-term more intensive maintenance necessary during and immediately after construction. Once all landscaping has been completed, maintenance will shift to Phase II.

As outlined in the section on Sediment and Erosion Control, Phase I will include weekly inspection of all sediment and erosion control devices plus “as needed” inspection after significant rainfall, with the repair of any damaged works and collection of captured sediment.

Phase II will be the maintenance carried out by the Township of Centre Wellington after all construction has been completed. This work will involve a yearly visual inspection of the stormwater management facilities and catch basins to determine the amount of sediment accumulation. Sediment should be removed as required and the recommended vegetation replanted.

8.0 CONCLUSIONS

From the foregoing analysis, the following conclusions are drawn:

- Water supply for the Ainley Farm Subdivision will be provided via the extension of a 200 mm diameter watermain along the Walser Street extension, Street No. 2 and a portion of Street No. 1. A 150 mm diameter watermain will be extended along the remainder of Street No. 1, Street No. 3, and Street No. 4.
- Sanitary service for the proposed lots along the Walser Street extension and a portion of Street No. 2 will be provided by the extension of a 200 mm diameter sanitary sewer from the existing 200 mm diameter sanitary sewer on Walser Street. Sanitary service for the remainder of the site will be provided by the extension of a 200 mm diameter sanitary sewer on easement from the existing 200 mm diameter sanitary sewer on Keating Drive.
- Storm sewers will be designed to convey the 5-year design storm event and will discharge to the two (2) stormwater management facilities and the existing storm sewer on Walser Street.
- Major storm runoff will be conveyed within the limits of the street right-of-ways to the two (2) stormwater management facilities and the existing Walser Street right-of-way.
- As per the Township of Centre Wellington municipal standards, foundation drainage will be collected in sump pits in each residential unit and pumped to the storm sewer system located within the municipal right-of-way.
- Quantity control for runoff generated from the development will be provided by two (2) stormwater management facilities,
- Quality control for runoff generated from the development will be provided by four (4) oil/grit separators (Stormceptor or approved equivalent).
- The post-development runoff generated from the site will be attenuated to the less than the proposed release rates to the existing wetland and to the Grand River tributary.
- Minor runoff generated from the site and conveyed to existing storm sewers on Walser Street is within 15% of the previously identified release rate and is contained below grade. Therefore, the existing storm sewer on Walser Street has capacity to convey the proposed 5-year post-development flow rates. Major stormwater flows to Walser Street exceed the release rate included in the Ville Lora Downs Subdivision by approximately 0.020m³/s under the major design storm events, equivalent to a 35% increase in contributing area. The increased runoff under major storms is minimal enough to be conveyed within the Walser Street and Keating Drive right-of-way.
- Infiltration rates from existing conditions have been maintained under post-development conditions via two (2) infiltration galleries.
- During the construction phase, the erosion control measures will minimize the transport of sediment off-site during the construction period.

All of which is respectfully submitted.

GM BLUEPLAN ENGINEERING LIMITED

Per:



Sarah Primmer, P. Eng.

SP/pw

W:\Kitchener\411-2011\411009\Documents\Reports, Manuals, Contracts\411009 Prelim Servicing and SWM Report_revised_2019-07-03.docx





APPENDIX A
PRELIMINARY GEOTECHNICAL INVESTIGATION
CMT ENGINEERING INC.
MARCH 29, 2006

**PRELIMINARY GEOTECHNICAL
INVESTIGATION**

**AINLEY SUBDIVISION
TOWNSHIP OF CENTRE WELLINGTON
VILLAGE OF ELORA, ONTARIO**

CMT Project 06-004

Prepared For:

Gamsby and Mannerow Limited

March 29, 2006





CMT Engineering Inc.
1011 Industrial Crescent, Unit 1
P.O. Box 159
St. Clements, Ontario N0B 2M0
Tel: 519-699-5775
Fax: 519-699-4664
www.cmtinc.net

March 29, 2006

06-004.R01

Gamsby and Mannerow Limited
255 Woodlawn Road West, Suite 210
Guelph, Ontario
N1H 8J1

Attention: Mr. Glenn Anderson, C.E.T.

Dear Sir:

**Re: Preliminary Geotechnical Investigation
Ainley Subdivision
Township of Centre Wellington
Village of Elora, Ontario**

As requested, CMT Engineering Inc. conducted a subsoil investigation at the above-referenced site, and we are pleased to present the enclosed report.

We trust that this information meets your present requirements and we thank you for this opportunity to have been of service. Should you have any questions, please do not hesitate to contact our office.

Yours very truly,

A handwritten signature in black ink, appearing to read 'Robert Koopmans', written over a series of horizontal, wavy lines that serve as a background for the signature.

Robert Koopmans, P.Eng.

ks

TABLE OF CONTENTS

	<u>Page</u>
1.0 INTRODUCTION.....	1
2.0 SITE CONDITIONS.....	1
3.0 FIELD AND LABORATORY PROCEDURES.....	1
4.0 SUBSOIL CONDITIONS.....	2
4.1 Topsoil.....	2
4.2 Organic Silt	2
4.3 Silt or Sandy Silt	2
4.4 Silt Till or Sandy Silt Till	2
4.5 Sand or Silty Sand	3
4.6 Clayey Silt	3
4.7 Groundwater Conditions	3
5.0 DISCUSSION	4
5.1 Site Grading	4
5.2 Site Dewatering	6
5.3 Excavations	6
5.4 Service Pipe Bedding	7
5.5 Trench Backfill	8
5.6 Sensitivity of Subsoils	9
5.7 Road Construction and Pavement Design	9
5.8 Bearing Capacity / Settlement	11
5.9 Residential Drainage Considerations	11
5.10 Potential Storm Water Management Facility	12
6.0 SITE INSPECTIONS	12
7.0 LIMITATIONS OF THE INVESTIGATION.....	13

Drawing 1 - Site Plan Showing Borehole Locations

Appendix A - Borehole Logs 101 to 108

Appendix B - Cross-Sections

Appendix C - Grain Size Analyses

Appendix D - Laboratory Proctor Test

Appendix E - Well Record

1.0 INTRODUCTION

The services of CMT Engineering Inc. were retained by Mr. Glenn Anderson of Gamsby and Mannerow Limited to carry out a subsurface investigation for the proposed Ainley Subdivision in the Township of Centre Wellington (Village of Elora).

It is our understanding that single-family and multi-family residences are proposed to be built on the eastern two-thirds of the property. The western one-third of the property is proposed for open space and may contain a storm water management pond.

The purpose of the investigation was to determine the subsurface soil profile, the water levels in the boreholes and provide recommendations with respect to site grading, bearing capacity for house foundations, trench excavations, bedding and backfilling for service pipes, site dewatering, road construction, pavement design recommendations and soil hydraulic conductivity for storm water management design.

2.0 SITE CONDITIONS

The geotechnical investigation was conducted on Part Lot 18, Concession 12 of the Township of Centre Wellington. In general, the eastern two-thirds of the property is currently farm land, while the western one-third is treed. The site topography undulates slightly and the ground surface elevation drops towards the southwest corner of the property.

3.0 FIELD AND LABORATORY PROCEDURES

On January 25, 2006, a track-mount CME 55 drillrig operated by Aardvark Drilling Inc. was used to drill eight (8) boreholes (referenced as Boreholes 101 to 108) to depths of between 3.5 m (11.5 ft) and 5.0 m (16.4 ft) below the existing ground surface elevation. Standard penetration tests were conducted at 0.76 m (2.5 ft) intervals to depths of 3.0 m (10.0 ft) and at 1.5 m (5.0 ft) intervals below 3.0 m (10.0 ft) in all boreholes. Monitoring wells were installed in all eight boreholes to determine the presence and depth of the groundwater table.

Technical staff from CMT Engineering Inc. observed the drilling operation and collected and logged the recovered soil samples. Soil samples taken from Borehole 102 (3.05 to 3.51 m), Borehole 103 (4.57 to 5.03 m), Borehole 105 (2.29 to 2.74 m) and Borehole 107 (2.29 to 2.74 m) were placed in marked sample bags for grain size analyses (refer to Appendix C for laboratory test results). A bulk sample from Borehole 103 (1.5 to 2.0 m) was submitted for laboratory Proctor testing (refer to Appendix D for the laboratory test results). A small portion of each sample was placed in a sealed marked jar for moisture content determinations.

Gamsby and Mannerow Limited surveyed the ground surface elevations for all boreholes, as well as the tops of the monitoring wells.

Drawing 1 shows the site plan with all of the borehole locations.

4.0 SUBSOIL CONDITIONS

The soil conditions at the borehole locations are summarized briefly below, while a more detailed stratigraphic description is provided in the borehole logs in Appendix A. Cross-section profiles through Boreholes 101-103-102-104 and Boreholes 105-106-107-108 are provided in Appendix B.

4.1 Topsoil

Dark brown silt topsoil was found at the top of all eight boreholes. The topsoil was frozen at the time of the investigation. The thickness of the topsoil ranged from 30 mm to 60 mm (average 42 mm).

4.2 Organic Silt

Organic silt was found underlying the topsoil in Borehole 103. The organic silt was saturated, loose and brown with some sand and occasional topsoil nodules. The moisture content of the organic silt was 83.5% and the N-count was 8 blows per 0.30 m.

4.3 Silt or Sandy Silt

Silt was found underlying the sandy silt in Borehole 105. The silt was very moist, loose and brown with some clay, trace sand and trace gravel. The moisture content of the silt was 18.5% and the N-count was 8 blows per 0.30 m.

Sandy silt was found underlying the topsoil in Borehole 102. In general, the sandy silt was moist, compact and brown with a trace of clay and a trace of gravel. The moisture content was 10.4% and the N-count was 12 blows per 0.30 m.

4.4 Silt Till or Sandy Silt Till

Glacial till comprising silt or sandy silt was found in all boreholes (101 to 108). In general, the silt till was moist, compact to very dense and brown with trace to some sand,

gravel and clay. The moisture content ranged from 6.8% to 20.4% (average 11.7%) and the N-count ranged from 14 to 100 blows per 0.30 m (average 37 blows per 0.30 m). The sandy silt fill was generally moist, compact to very dense and brown with trace to some sand, gravel and clay. The moisture content ranged from 7.6% to 26.7% (average 13.4%) and the N-count ranged from 7 to 100 blows per 0.30 m (average 36 blows per 0.30 m).

4.5 Sand or Silty Sand

Sand was found in Boreholes 101, 102, 105 and 107. In general, the sand was very moist to wet, compact and brown with trace silt and/or trace gravel. The moisture content ranged from 14.3% to 20.0% (average 17.2%) and the N-count ranged from 7 to 22 blows per 0.30 m (average 15 blows per 0.30 m).

Silty sand was found in Boreholes 101, 103, 104, 105, 106 and 108. In general, the silty sand was wet to saturated, compact and brown with occasional trace gravel. The moisture content ranged from 10.5% to 27.7% (average 20.8%) and the N-count ranged from 1 to 25 blows per 0.30 m (average 10 blows per 0.30 m).

4.6 Clayey Silt

A localized layer of clayey silt was found in Borehole 107. The clayey silt was moist, compact and brown with trace sand and trace gravel. The moisture content was 13.6% and the N-count was 11 blows per 0.30 m.

4.7 Groundwater Conditions

Monitoring wells were installed in all boreholes. The monitoring wells were constructed utilizing 50 mm Schedule 40 PVC pipe with a 3 m long slot 10 screen surrounded by the sand filter comprising #3 industrial sand. The boreholes were backfilled with 3/8" bentonite holeplug from the top of the sand filter to the existing ground surface. For protection and security purposes, locking steel protective covers were installed on all of the monitoring wells.

A copy of the well record has been included in Appendix E. It is a requirement of Regulation 903 of the Ontario Water Resources Act that the monitoring well installations be abandoned within 180 days after they are no longer in use.

At the time of writing, the static water levels in the monitoring wells had been read on February 8, 2006, February 20, 2006, March 9, 2006, March 25, 2006 and March 29, 2006. A summary showing the ground surface, borehole bottom and water level elevations for Boreholes 101 to 108 are provided below:

Borehole No.	Ground Surface Elevation (m)	Elevation of Borehole Bottom (m)	Elevation of Water Table (m) (F) - Frozen				
			Feb 8, 2006	Feb 20, 2006	Mar 9, 2006	Mar 25, 2006	Mar 29, 2006
101	413.64	408.64	413.07	413.11	412.83	412.96	--
102	414.37	409.37	411.57	411.96	411.91	412.48	--
103	414.89	409.89	412.65	412.98	412.88	412.77	--
104	410.93	407.43	410.36	410.60	410.17	410.66	--
105	414.05	409.28	414.05	414.07 (F)	414.15 (F)	414.15 (F)	414.68
106	410.91	405.94	410.67	410.86 (F)	410.93 (F)	410.75	--
107	409.58	406.08	409.43	409.06 (F)	409.12 (F)	409.41	--
108	410.32	406.82	409.06	409.21	408.82	409.01	--

Due to the close proximity of the groundwater to the ground surface, some of the monitoring wells were frozen at the time of the water level readings.

The groundwater levels will be measured on a monthly basis in an effort to try and establish extreme (high and low) groundwater elevations.

5.0 DISCUSSION

It is our understanding that the property owner is proposing to develop a residential subdivision on the property investigated. The subdivision will be fully serviced with municipal sewers and water supply. A storm water management facility is proposed to be constructed in the western portion of the site.

5.1 Site Grading

Prior to the commencement of any site grading, all topsoil and organic silt soils (Borehole 103) must be removed from the proposed building envelopes (including extended zone of influence areas), road allowance and driveways.

Due to the high water table and isolated wet surface conditions, it may be necessary to utilize an excavator during topsoil stripping to minimize over-excavation as a result of soil disturbance from heavy construction traffic.

At this time, the proposed founding elevations for the residences are not available. However, it would appear that some cut and fill operations will be required to level the building site.

Prior to any placement of structural fill, the subgrade for the building envelope must be prepared large enough to accommodate a 1:1 slope commencing at a distance of 1.0 m beyond the outside edge of the proposed foundation down to approved native founding soils.

Soils approved for use as structural fill must be placed in loose lifts not exceeding 0.3 m (1 ft) in depth for granular soils and 0.2 m (8") in depth for fine grained (silt and clay) soils and compacted using adequate heavy vibratory padfoot compaction equipment to a minimum of 98% standard Proctor maximum dry density (SPMDD). The approved structural fill materials must be free of frozen materials, organics or other deleterious materials and must not contain particles exceeding 150 mm (6") in diameter. The soils must be at moisture contents suitable to achieve the specified compaction.

A laboratory Proctor moisture-density test was performed on a bulk sample of the silt till from Borehole 103 (depth 1.5 to 2.0 m). The results of the laboratory Proctor test indicate that the optimum moisture content of the sample is 8.3%. Since the insitu moisture contents of the split spoon sample of silt till ranged from 6.8% to 20.4% (average 11.7%), it should be anticipated that the majority of the silt till will require air-drying in order to achieve the specified compaction during construction.

The fine grained soils encountered in the geotechnical investigation are highly susceptible to strength losses if subjected to frequent disturbance by construction traffic. Therefore, it is recommended to minimize construction traffic on subgrade soils.

It would be recommended that the site grading and underground service installation be undertaken during drier warm weather conditions in order to minimize dewatering operations, eliminate frost problems and most importantly improve the placement and compaction of structural fill and backfill materials. Proper compaction and backfilling operations are imperative in order to provide adequate support for structures, service pipes, driveway and roadways.

If site grading and site servicing is undertaken during cold or wet weather conditions, projected overall costs would be anticipated to be higher and the project would be expected to take longer to complete.

5.2 Site Dewatering

Based on this geotechnical investigation and similar high water tables encountered during the construction of the neighbouring Ville Lora Downs Subdivision, water concerns should be anticipated for this project. Static water levels measured in the monitoring wells suggest that perched groundwater can be expected at the locations of Boreholes 101, 102, 103, 105 and 106 which were advanced within the proposed residential development area. The water appears to be surface water that has perched on top of the relatively impermeable sandy silt till, sandy silt and silt till soils. Furthermore, artesian conditions can also be expected at the locations of Boreholes 101, 102 and 103. The artesian water appears to be located between the upper sandy silt till and lower silt till in Borehole 101, between the upper and lower silt tills in Borehole 102 and below the silt till layer in Borehole 103.

Provisions for site dewatering should be part of the site development and construction process. Normally, it would be recommended that well points be installed in order to dewater the site so that site services and residential foundations could be installed. However, based on past experience, the installation of a well point dewatering system by qualified contractors can be very expensive and not necessarily guaranteed. It is probably most cost-effective to install a series of inverted drainage pipes in advance of the service (sanitary, storm and water) trench excavations and also at the locations of the manholes. Water pumps should be utilized to pump water from the inverted pipes on a continuous basis in order to keep the water table drawn down below the excavation level. Temporary drainage trenches should be constructed to remove the site water to a storm water retention pond (or reasonable alternative). The removal of considerable amounts of fine soil particles from the pumping operation can be anticipated. As such, the drainage trenches, storm water pond, pumps and hoses will most likely require regular cleanout. It might be cost-effective in regard to road construction and house construction to investigate the possibility of installing a permanent deep drainage system to lower the water table in the immediate area. Caution would be necessary with this option, since it could affect wells and building structures on adjacent properties.

The dewatering conditions may improve if work is conducted during the drier summer months as well as following the installation of the services.

5.3 Excavations

The anticipated sanitary, storm and water pipe invert elevations are all expected to be well below the water table and therefore site dewatering will be required (see Section 5.2 above). Based on observations from the neighbouring Ville Lora Downs Subdivision, the water levels in the summer are generally lower and therefore dewatering requirements

may be less. However, the anticipated effects of the artesian water conditions are still expected to be of concern.

All excavations must be carried out in accordance with Ontario Regulation 213/91 (Reg 213/91) of the Occupational Health and Safety Act and Regulations for Construction Projects.

Type 2 Soils: The native glacial till soils would be classified as Type 2 soils under Reg 213/91 and must be sloped to within 1.2 m of the bottom of the excavation at a minimum gradient of 1 horizontal to 1 vertical. Where excavations expose glacial till soils underlain by wet sand or silt soils, the recommendations for Type 4 soils below must be adhered to.

Type 3 Soils: The native sand and silt soils in an unsaturated condition (above the water table) would be classified as Type 3 soils under Reg 213/91 and must be sloped from the bottom of the excavation at a minimum gradient of 1 horizontal to 1 vertical.

Type 4 Soils: All native sand or silt soils in a saturated condition (below the water table) would be classified as Type 4 soils under Reg 213/91. Excavations that expose the Type 2 and Type 3 soils noted above but are underlain by saturated sand or silt soils must be treated as Type 4 soils as well. Type 4 soils must be sloped at a minimum gradient of 3 horizontal to 1 vertical. The loose wet condition of the Type 4 soils makes them very susceptible to sloughing and slope failure during excavation.

If it is not practical to excavate according to the above requirements, then a trench box system (designed in accordance with the Ontario Health and Safety Act Regulations) may be utilized.

It should be noted that some of the native glacial till soils become very dense with depth (N-values in excess of 100 blows per 0.30 m) and may prove difficult to excavate with conventional excavating equipment. It is also imperative that when the very dense soils are utilized for backfilling of service trenches, the material must be broken down (pulverized) to minimize voids and reduce the potential for settlement.

5.4 Service Pipe Bedding

The native soils are generally considered to be suitable for indirect support of the proposed service pipes. Where water inflow is a concern and the soil conditions are not suitable to support the pipe, then 80 mm to 120 mm (3" to 5") river stone (or equivalent) with a 150 mm (6") layer of 19 mm clear stone should be used to create an adequate supporting base for the pipe.

Pipe embedment and backfill for flexible pipes should be undertaken in accordance with OPSD-802.010. Pipe embedment, cover and backfill for rigid pipes should be undertaken in accordance with OPSD-802.030 or OPSD-802.031. Trenching, backfilling and compaction with respect to storm sewer pipe installations should comply with OPSS 514.

Flexible Pipes: The pipe bedding should be shaped to receive the bottom of the pipe. If necessary, pipe culvert frost treatment should be undertaken in accordance with OPSD-803.030 and OPSD-803.031. The trench excavations should be symmetrical with respect to the centreline of the pipe. The granular material placed under the haunches of the pipe must be compacted to 95% SPMDD prior to the continued placement and compaction of the embedment material. The homogeneous granular material used for embedment should be placed and compacted uniformly around the pipe. Should wet conditions be encountered at the base of the trench, then the pipe should consist of 19 mm clear stone (meeting OPS Specifications). Normally, it would be advisable to wrap the clear stone with geotextile to prevent fine soils from entering the clear stone and thereby creating voids around the pipe. In wet conditions, this is not possible to do and generally not necessary since most of the void spaces are quickly filled with fine soils as water (with suspended fine soils) rapidly enters the excavation. It is imperative that the newly installed pipe be backfilled as soon as possible in order to prevent the potential for pipe uplift. This can occur due to buoyancy, as water enters the excavation. It is also advisable to check the elevation of the installed pipe at regular intervals to ensure that uplift has not occurred. Protection against heavy construction equipment should be undertaken in accordance with OPSD-808.010.

Rigid Pipes: In general, the pipe installation recommendations for rigid pipes are the same as those for flexible pipes except that the minimum depth of bedding below a rigid pipe should be $0.15 D$ (where D is the pipe diameter). In no case should this dimension be less than 150 mm or greater than 300 mm.

5.5 Trench Backfill

Native backfill material can be used to fill the trench from 12" (30 cm) above the pipe to the subgrade elevation provided that the material is free of organics, not frozen and is not overly wet (above the optimum moisture).

Based on the existing water table, the moisture contents determined from soil samples that were taken during the geotechnical investigation, and the laboratory Proctor test (see Appendix C), it can be assumed that most soils will be too wet to enable proper compaction. As such, these soils should be allowed to drain and air-dry as long as possible before backfilling.

If wet or frozen soils are used for backfill purposes, proper compaction of the backfill will not be possible and settlement of the trenches can be expected. Site assessments will be required to determine what options can be undertaken to construct a suitable road base. These options may include subexcavating and increasing the thickness of the granular subbase, the possible use of high strength geotextiles, or a combination of both.

5.6 Sensitivity of Subsoils

The silty nature of many of the soils encountered in the boreholes can make them highly susceptible to strength losses and will prove difficult to place and compact if they become overly wet as a result of inclement weather or water seepage. If the soils become overly wet and disturbed, they may become unsuitable for reuse and require subexcavation. As such, the following is recommended:

- provide proper measures for adequate drainage during construction
- use a smooth-lipped bucket while excavating to the subgrade elevation to reduce disturbance
- minimize construction traffic traveling over the subgrade soils

5.7 Road Construction and Pavement Design

In order to achieve a suitable subgrade for the construction of the pavement structure, the following recommendations are provided:

- a) If necessary, maintain the site dewatering system during preparation of the road subgrade. Once the road subgrade is completed, the drainage pipes should be removed or cut off at the subgrade elevation and infilled with lean concrete or a bentonite slurry.
- b) The design subgrade for the road should be proof-rolled using heavy rubber-tire equipment, such as a grader. Compactive effort should be applied and compaction tests should be undertaken. Areas requiring fill to achieve the subgrade elevation should be treated as indicated above prior to placement of any additional fill. The subgrade should be evaluated to determine if subexcavation and additional Granular 'B' will be required or if the installation of a reinforcing geotextile will be necessary.
- c) The road subgrade should be cut to grade using a smooth-lipped bucket. The subgrade should be graded smooth (with no depressions) and sloped at a minimum of 2%. Construction traffic should not be allowed onto the prepared road subgrade. Construction traffic should travel only on the Granular 'B' subbase. It may be necessary to temporarily

increase the thickness of the Granular 'B' during road construction to accommodate the truck traffic.

d) It is recommended that 100 mm diameter perforated subdrains fitted with a filter sock be installed along each curb line to collect and redirect water beneath the pavement surface. It is suggested that the subdrains be installed in a 0.3 m (1 ft) by 0.3 m (1 ft) trench and placed approximately 50 mm (2") from the trench bottom. In drier conditions, the perforated subdrain with a factory-installed filter sock can be installed in Granular 'A' bedding. In wet conditions, 19 mm clear stone wrapped completely in non-woven geotextile (such as Terrafix 270R or equivalent) is recommended. Rapid drainage of the pavement structure is critical to ensure long-term performance of the road.

Based on the anticipated loading and considering that the subsoils contain frost-susceptible soils, the following pavement design is recommended for the proposed roads:

Material	Recommended Thickness
Asphaltic Concrete	HL3 - 40 mm (1.5") HL4 or HL8 - 50 mm (2.0")
Granular 'A' Base	150 mm (6.0")
Granular 'B' Subbase	450 mm (18.0")

The granular subbase materials should be compacted to 100% SPMDD. Asphaltic concrete should be supplied, placed and compacted to 97% Marshall bulk relative density in accordance with OPSS 1150 and OPSS 310.

The pavement should be designed to ensure that water will not pond on the pavement surface. If the surface asphalt is not placed in a reasonable time following the placement of the binder asphalt, it is recommended that the catch basin lids be lowered or apertures provided to allow the surface water to drain rather than accumulating around the catch basins.

5.8 Bearing Capacity / Settlement

The proposed residential buildings may be supported on conventional spread and pier footings provided they are founded on undisturbed native soils at or below the elevations listed in the following table or structural fill prepared as detailed in Section 5.1 of this report:

Borehole No.	Existing Ground Surface Elevation (m)	Highest Recommended Footing Elevation (m)	Soil Type
101	413.64	413.01	sandy silt till
102	414.37	412.70	silt till
103	414.89	413.59	silt till
105	414.05	411.65	sandy silt till
106	410.91	408.51	silt till

It is ideally recommended that foundations be constructed above the water table. The native founding soils and structural fill in a drained condition would be considered suitable to support foundations designed with a safe net allowable bearing capacity of 150 kPa. It is anticipated that the water table may be within one footing width below the founding elevation. Therefore, a safe net allowable bearing capacity of 75 kPa should be used for design purposes.

With respect to the bearing capacities as determined above, total and differential settlements are estimated to be within the generally acceptable limits of 25 mm (1") and 19 mm (3/4") respectively.

A minimum of 1.2 m (4 ft) of soil cover above the footing grade must be provided for frost protection.

5.9 Residential Drainage Considerations

If high water conditions continue to exist during the construction of the residential foundations, and the foundations are constructed near or below the water table, then the following will be required:

- a granular drainage layer and sump pump will be required as per Section 9.14.4 of the current Ontario Building Code

- slab-on-grades constructed where groundwater levels may cause hydrostatic pressure must be designed to resist such pressures
- slab-on-grade and exterior walls must be waterproofed

If foundation construction occurs above the high water table, then conventional construction methods can be utilized.

5.10 Potential Storm Water Management Facility

Boreholes 104, 107 and 108 were all drilled in the open space area (west side of property) where a storm water management facility is proposed. In general, Borehole 104 has silt till underlain by silty sand. It would appear that artesian conditions are present in the silty sand layer below the more impermeable silt till layer. Based on the monitoring well readings, the water level fluctuates to just below the ground surface elevation.

In general, Borehole 107 has sand underlain by clayey silt and lower sandy silt till. Artesian conditions may be present in the sandy silt till below the more impermeable clayey silt layer. Based on the monitoring well readings, the water level was just below the ground surface elevation. The upper sand layer has a high moisture content due to the infiltration of surface water, which is in turn impeded by the lower clayey silt layer.

In general, Borehole 108 has silty sand underlain by sandy silt till. Artesian conditions may be present in the lower portion of the sandy silt layer below the more impermeable silty sand layer (higher density, lower moisture). Based on the monitoring well readings, the water level has fluctuated to within approximately 1.0 m of the ground surface elevation.

Based on the results of the geotechnical investigation, it can be concluded that the soil and groundwater conditions in the area of Boreholes 104, 107 and 108 are unsuitable for an inground storm water management facility.

6.0 SITE INSPECTIONS

Site grading, dewatering, trench excavations, backfilling and compaction of the service pipes should be supervised by qualified geotechnical personnel to ensure that a suitable subbase is prepared, proper backfill materials are used and that the specified compaction is achieved.

The construction of the pavement structure should also be supervised by qualified personnel to ensure that suitable materials are used and that the specified compaction is achieved. It is also

recommended that the residential foundation excavations be examined to ensure that the bearing capacity of the soil is suitable to support the structures.

CMT Engineering Inc. would be pleased to provide inspection, testing and consulting services for this project.

7.0 LIMITATIONS OF THE INVESTIGATION

This investigation was conducted to determine the subsurface conditions for this project and the comments are based on the information gathered at the borehole locations only. It is therefore assumed that the borehole information is representative of the subsoil conditions across the site. Should any conditions at the site be encountered which differ from those found at the borehole locations, we request that we be notified immediately.

This report is intended solely for the client named. Any use which a third party makes of this report, or any reliance on or decisions to be made based on it, are the responsibility of such third parties.

We trust that this report meets with your present requirements. Should you have any questions, please do not hesitate to contact our office.

Respectfully submitted,

Robert Koopmans, P.Eng.
Consulting Engineer



Tim Salter, C.E.T.



ks

Base plan provided by:



QUALITY AND PROFESSIONALISM
CONSULTING ENGINEERS AND ARCHITECTS



CMT ENGINEERING INC.

1011 Industrial Crescent, Unit 1
St. Clements, Ontario N0B 2M0
Tel.: 519-699-5775
Fax: 519-699-4664
www.cmtinc.net

BOREHOLE LOCATION

PLAN

Ainley Subdivision
Township of Centre
Wellington
Village of Elora, ON

Project: 06-004 Drawing: 2

Date: Mar. 2006 Sheet: 1

Scale: 1:2000

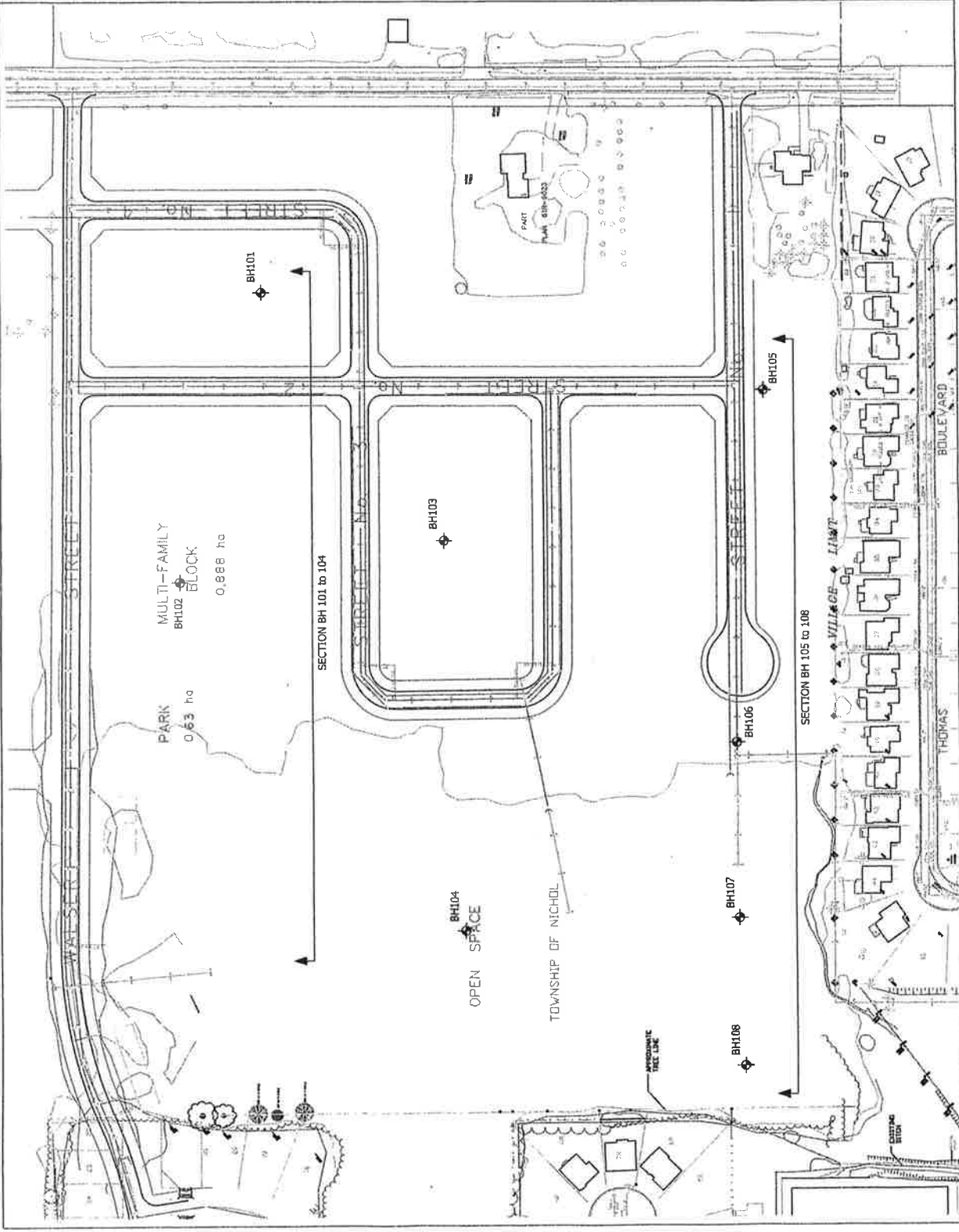

APPENDIX A

**BOREHOLE LOGS
Boreholes 101 to 108**

BOREHOLE 101

Date Drilled: Jan. 25, 2006
Rig: CME 55
Contractor: Aardvark
Drilling Method: HSA

Elevation: 413.64m
Logged by: CD

Project No.: 06-004
Project: Ainley Subdivision
 Township of Centre Wellington
Location: Elora

Depth (ft/m)	Sample Type	Recovery (%)	Sample Number	Symbols	SOIL DESCRIPTION	Well Installation	Moisture Content %		Pocket Penetrometer		
							Wp [---X---] Wl	SPT (N)	kPa	Blows/0.3 m	
0					Ground Surface (m) 413.64	<p>50mm schedule 40 PVC pipe with slot 10 screen Bentonite Seal #3 Sand Filter Feb 8/06 Stick up well with protective metal casing</p>					
0					<i>Topsoil</i> Dark brown silt, frozen 0.00						
1					413.31						
1					<i>Sandy Silt Till</i> Compact brown sandy silt till, some clay, some gravel, moist 0.33						
3	SS		1					9.7		22	
4											
5											
6	SS		2		411.84			20.7		20	
6					<i>Sand</i> Compact brown sand, very moist to wet 1.80						
7					411.54						
7					<i>Silty Sand</i> Compact brown silty sand, wet 2.10						
8	SS		3					24.9		14	
9											
10											
11	SS		4		spoon sank through silty sand under weight of rods			27.7		1	
12											
13					409.64						
13					<i>Sand</i> Dense brown sand, trace silt, wet 4.00						
14											
15					408.94		20.4		40		
15	SS		5		<i>Silt Till</i> Dense brown silt till, some sand, gravel and clay, moist 4.70						
16					408.64						
16					<i>Silt Till</i> Dense brown silt till, some sand, gravel and clay, moist 5.00						
17					End of Borehole						
18											
19											

CMT ENGINEERING INC.
 1011 Industrial Crescent, Unit 1
 St. Clements, Ontario N0B 2M0
 phone 519-899-5775 fax 519-899-4664
 www.cmtlinc.net



BOREHOLE 102

Date Drilled: Jan. 25, 2006
Rig: CME 55
Contractor: Aardvark
Drilling Method: HSA

Elevation: 414.37m
Logged by: CD

Project No.: 06-004
Project: Ainley Subdivision
 Township of Centre Wellington
Location: Elora

Depth (ft/m)	Sample Type	Recovery (%)	Sample Number	Symbols	SOIL DESCRIPTION	Well Installation	Moisture Content % Wp [---X---] Wl	Pocket Penetrometer
								kPa
								100 300
								SPT (N)
								Blows/0.3 m
								10 30 50 70 90
0					Ground Surface (m) 414.37			
0					Topsoil			
1					Dark brown silt, frozen 414.07			
1					Sandy Silt			
2					Compact mottled brown sandy silt till, trace clay, trace gravel, moist 413.00			
3	SS		1				10.4	12
4								
5					Silt Till			
6	SS		2		Compact brown silt till, trace sand, trace gravel, moist 411.77		17.6	15
7								
8	SS		3				4.8	30
9					Sand			
10					Compact brown sand, trace silt, trace gravel, moist to very moist 410.37			
11	SS		4				20.0	22
12								
13					Silt Till			
14					Dense grey silt till, trace sand gravel and clay, moist 409.37			
15							7.7	53
16	SS		5					
17					End of Borehole 5.00			
18								
19								

CMT ENGINEERING INC.
 1011 Industrial Crescent, Unit 1
 St. Clements, Ontario N0B 2M0
 phone 519-699-5775 fax 519-699-4684
 www.cmtinc.net



BOREHOLE 103

Date Drilled: Jan. 24, 2006
Rig: CME 55
Contractor: Aardvark
Drilling Method: HSA

Elevation: 414.89m
Logged by: CD

Project No.: 06-004
Project: Ainley Subdivision
 Township of Centre Wellington
Location: Elora

Depth (ft/m)	Sample Type	Recovery (%)	Sample Number	Symbols	SOIL DESCRIPTION	Well Installation	Moisture Content %		Pocket Penetrometer		
							Wp [---X---] Wl	SPT (N)	kPa	Blows/0.3 m	
0					Ground Surface (m) 414.89	<p>Bentonite Seal</p> <p>#3 Sand Filter</p> <p>50mm schedule 40 PVC pipe with slot 10 screen</p> <p>412.65m (Feb 8/06)</p> <p>Stick up well with protective metal casing</p>					
0					Topsoil Dark brown silt, frozen						
1					414.34						
2					Organic Silt Loose brown organic silt, some sand, occasional topsoil nodule, very moist						
3	SS		1		413.89						>508
4					Silt Till Compact brown silt till, trace sand, trace gravel, moist, becoming dense with depth						
5					411.54			13.6		20	
6	AS		2		3.35						
7					410.89						
8	SS		3		Becoming loose, trace clay, saturated			9.2		32	
9					411.54						
10					3.35						
11	SS		4		Silty Sand Dense brown silty sand, wet			13.1		37	
12					410.89						
13					4.00						
14					410.89						
15					4.00						
16	SS		5		End of Borehole			23.1		6	
17					409.89						
18					5.00						
19											

CMT ENGINEERING INC.
 1011 Industrial Crescent, Unit 1
 St. Clements, Ontario N0B 2M0
 phone 519-699-5775 fax 519-699-4664
 www.cmtinc.net



BOREHOLE 104

Date Drilled: Jan. 24, 2006
Rig: CME 55
Contractor: Aardvark
Drilling Method: HSA

Elevation: 410.93m
Logged by: CD

Project No.: 06-004
Project: Ainley Subdivision
 Township of Centre Wellington
Location: Elora

Depth (ft/m)	Sample Type	Recovery (%)	Sample Number	Symbols	SOIL DESCRIPTION	Well Installation	Moisture Content % Wp [---X---] Wl	Pocket Penetrometer kPa SPT (N) Blows/0.3 m
0					Ground Surface (m) 410.93			
0.00					<i>Topsail</i> Dark brown silt, frozen			
1					410.63			
1.30					<i>Silt Till</i> Compact dark brown silt till, some clay, trace sand, trace gravel, moist			
3	SS		1				10.2	14
4					409.56			
5					<i>Silty Sand</i> Compact brown silty sand, saturated			
5.137								
6	SS		2				23.0	14
7								
8	SS		3				17.8	8
9								
10								
10.3								
11	SS		4				25.9	10
12					407.43			
12.350					End of Borehole			
13								
14								

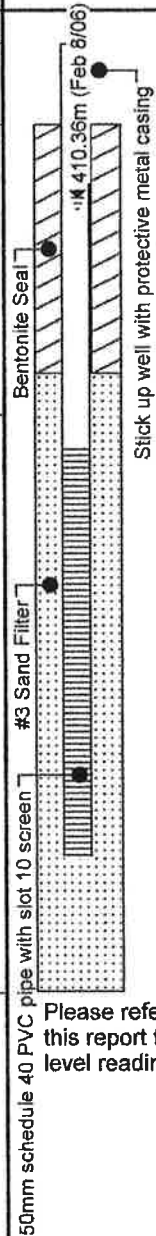

Please refer to section 4.7 of this report for additional water level readings



BOREHOLE 105

Date Drilled: Jan. 25, 2006
 Rig: CME 55
 Contractor: Aardvark
 Drilling Method: HSA

Elevation: 414.05m
 Logged by: CD

Project No.: 06-004
 Project: Ainley Subdivision
 Township of Centre Wellington
 Location: Elora

Depth (ft/m)	Sample Type	Recovery (%)	Sample Number	Symbols	SOIL DESCRIPTION	Well Installation (Feb 8/06)	Moisture Content % Wp [---X---] Wl 10 20 30 40	Pocket Penetrometer kPa 100 300 SPT (N) Blows/0.3 m 10 30 50 70 90
0					Ground Surface (m) 414.05			
0					Topsoil 0.00 Dark brown silt, frozen			
1					413.67			
2					Silty Sand 0.38 Loose red-brown silty sand, moist			
3	SS		1				18.5	4
4					412.68			
5					Silt 1.37 Loose brown silt, some clay, trace sand, trace gravel, very moist		18.5	8
6	SS		2					
7					412.05			
8					Sand 2.00 wet sand seam at 2.0m depth		7.7	26
9					Sandy Silt Till Very dense brown sandy silt till, some clay, trace gravel, moist			
10	SS		3				8.1	100
11	SS		4					
12								
13								
14								
15	SS		5				7.6	100
16					409.28			
17					End of Borehole 4.77			

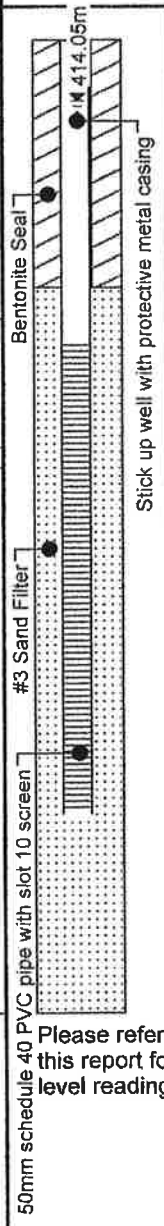

Please refer to section 4.7 of this report for additional water level readings

CMT ENGINEERING INC.
 1011 Industrial Crescent, Unit 1
 St. Clements, Ontario N0B 2M0
 phone 519-699-5775 fax 519-699-4664
 www.cmtinc.net



BOREHOLE 106

Date Drilled: Jan. 25, 2006
Rig: CME 55
Contractor: Aardvark
Drilling Method: HSA

Elevation: 410.91m
Logged by: CD

Project No.: 06-004
Project: Ainley Subdivision
 Township of Centre Wellington
Location: Elora

Depth (ft/m)	Sample Type	Recovery (%)	Sample Number	Symbols	SOIL DESCRIPTION	Well Installation 50mm schedule 40 PVC pipe with slot 10 screen Bentonite Seal #3 Sand Filter Stick up well with protective metal casing	Moisture Content %		Pocket Penetrometer	
							Wp [---X---] Wl	SPT (N)	kPa	Blows/0.3 m
							10 20 30 40	10 30 50 70 90		
0					Ground Surface (m) 410.91					
0					Topsoil Dark brown silt, frozen	0.00				
1					410.59					
2					Silty Sand Loose mottled grey silty sand, trace gravel, moist	0.32				
3	SS		1					24.0	9	
4										
5								12.1	9	
6	SS		2							
7					408.81					
8					Sandy Silt Till Dense to very dense grey sandy silt till, trace sand, trace gravel, moist	2.10				
9	SS		3					6.8	33	
10										
11	SS		4					8.3	28	
12										
13										
14										
15										
16	SS		5					9.0	100	
17					405.94					
18					End of Borehole	4.97				
19										

CMT ENGINEERING INC.
 1011 Industrial Crescent, Unit 1
 St. Clements, Ontario N0B 2M0
 phone 519-699-5775 fax 519-699-4664
 www.cmtinc.net



BOREHOLE 107

Date Drilled: Jan. 24, 2006
Rig: CME 55
Contractor: Aardvark
Drilling Method: HSA

Elevation: 409.58m
Logged by: CD

Project No.: 06-004
Project: Ainley Subdivision
 Township of Centre Wellington
Location: Elora

Depth (ft/m)	Sample Type	Recovery (%)	Sample Number	Symbols	SOIL DESCRIPTION	Well Installation	Moisture Content % Wp [---X---] Wl	Pocket Penetrometer
								kPa
0					Ground Surface (m) 409.58			
0					Topsoil Dark brown silt, frozen			
2					408.98			
2.60					Sand Loose red-brown sand, some silt, moist to wet			
3	SS		1				14.3	7
4					408.21			
4.137					Clayey Silt Compact brown clayey silt, trace sand, trace gravel, moist			
5	SS		2				13.6	11
6					407.48			
6.210					Sandy Silt Till Compact to loose brown sandy silt till, trace clay, saturated			
7	AS		3				19.1	25
8					406.08			
8.350					End of Borehole			
9	SS		4				17.3	7
10								
11								
12								
13								
14								

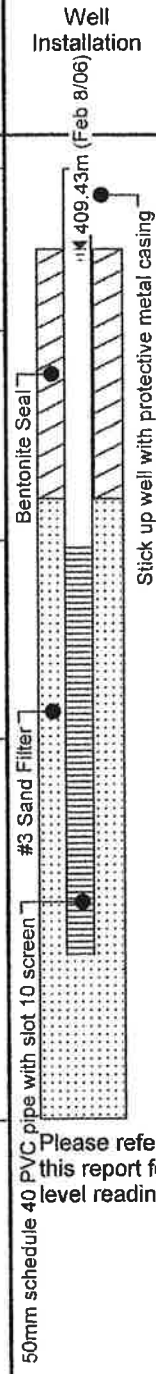

Please refer to section 4.7 of this report for additional water level readings

CMT ENGINEERING INC.
 1011 Industrial Crescent, Unit 1
 St. Clemente, Ontario N0B 2M0
 phone 519-699-5775 fax 519-699-4664
 www.cmlinc.net



BOREHOLE 108

Date Drilled: Jan. 25, 2006
 Rig: CME 55
 Contractor: Aardvark
 Drilling Method: HSA

Elevation: 410.32m
 Logged by: CD

Project No.: 06-004
 Project: Ainley Subdivision
 Township of Centre Wellington
 Location: Elora

Depth (ft/m)	Sample Type	Recovery (%)	Sample Number	Symbols	SOIL DESCRIPTION	Well Installation	Moisture Content % Wp [---X---] Wl 10 20 30 40	Pocket Penetrometer kPa 100 300 SPT (N) Blows/0.3 m 10 30 50 70 90
0					Ground Surface (m) 410.32			
0.00					<i>Topsoil</i> Dark brown silt, frozen			
2					409.74			
0.58					<i>Silty Sand</i> Compact mottled brown silty sand, trace gravel, moist			
3	SS		1				10.5	25
4					408.95			
1.37					<i>Sandy Silt Till</i> Dense to loose brown sandy silt till, wet			
5	SS		2				16.8	38
6								
7								
8	SS		3				19.9	18
9								
10								
3					406.82			
26.7	SS		4				26.7	7
11								
12					End of Borehole	3.50		
13								
4								
14								

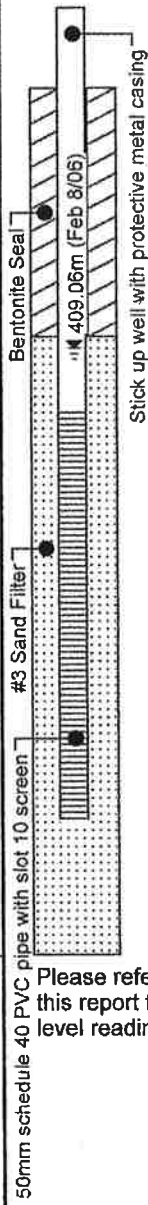

Please refer to section 4.7 of this report for additional water level readings

CMT ENGINEERING INC.
 1011 Industrial Crescent, Unit 1
 St. Clements, Ontario N0B 2M0
 phone 519-699-5775 fax 519-699-4664
 www.cmtinc.net



APPENDIX B
CROSS-SECTIONS

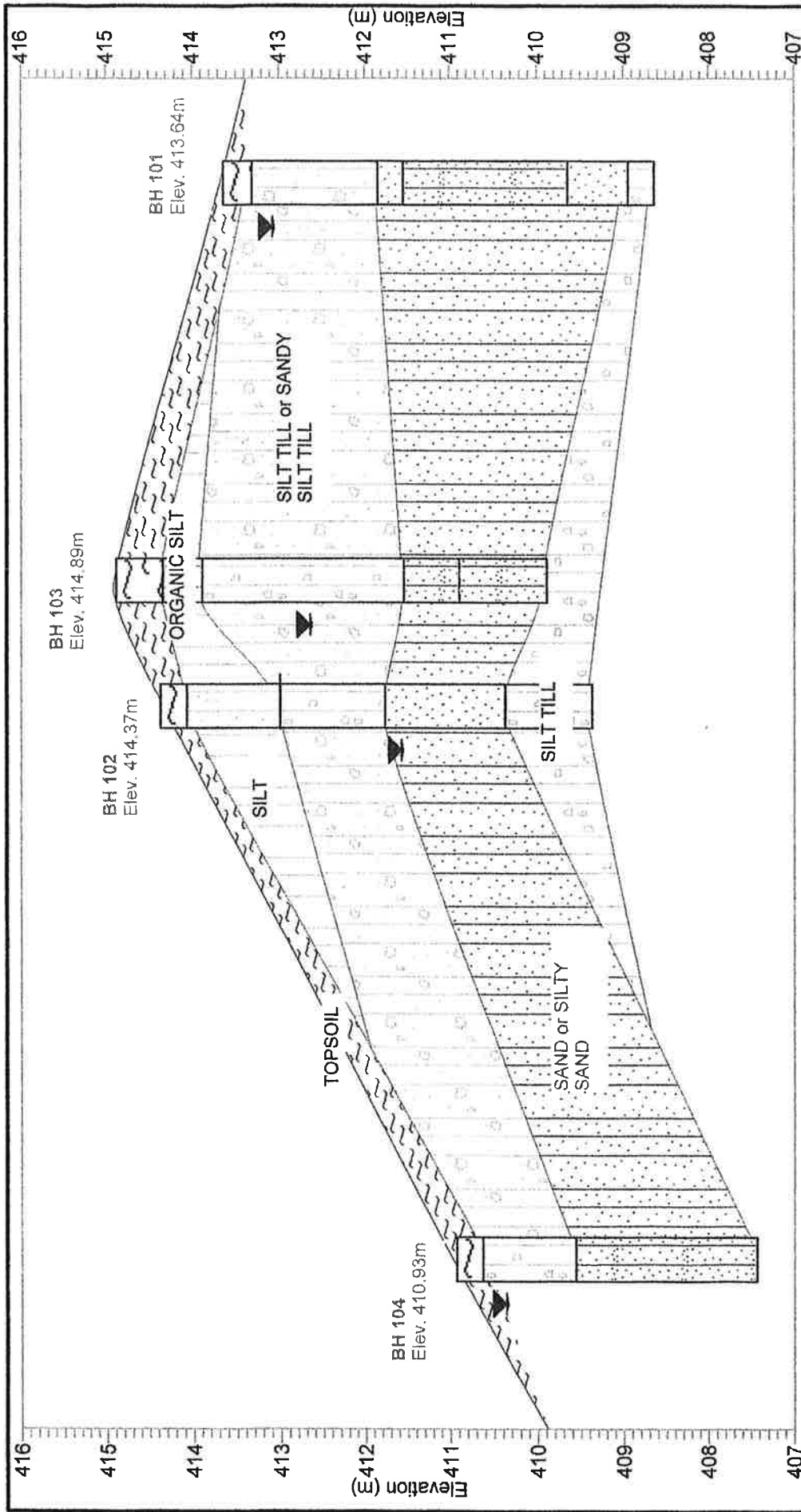

NOTE: Water levels shown were measured on Feb. 8, 2006. Please refer to Section 4.7 of this report for additional water levels.

Project: AINLEY SUBDIVISION
 Project Number: 06-004
 Location: Elora, Ontario
 Drawn By: JS
 Date: February, 2006

CMI ENGINEERING INC.
 1011 Industrial Cres.,
 Unit 1
 St. Clements, Ontario

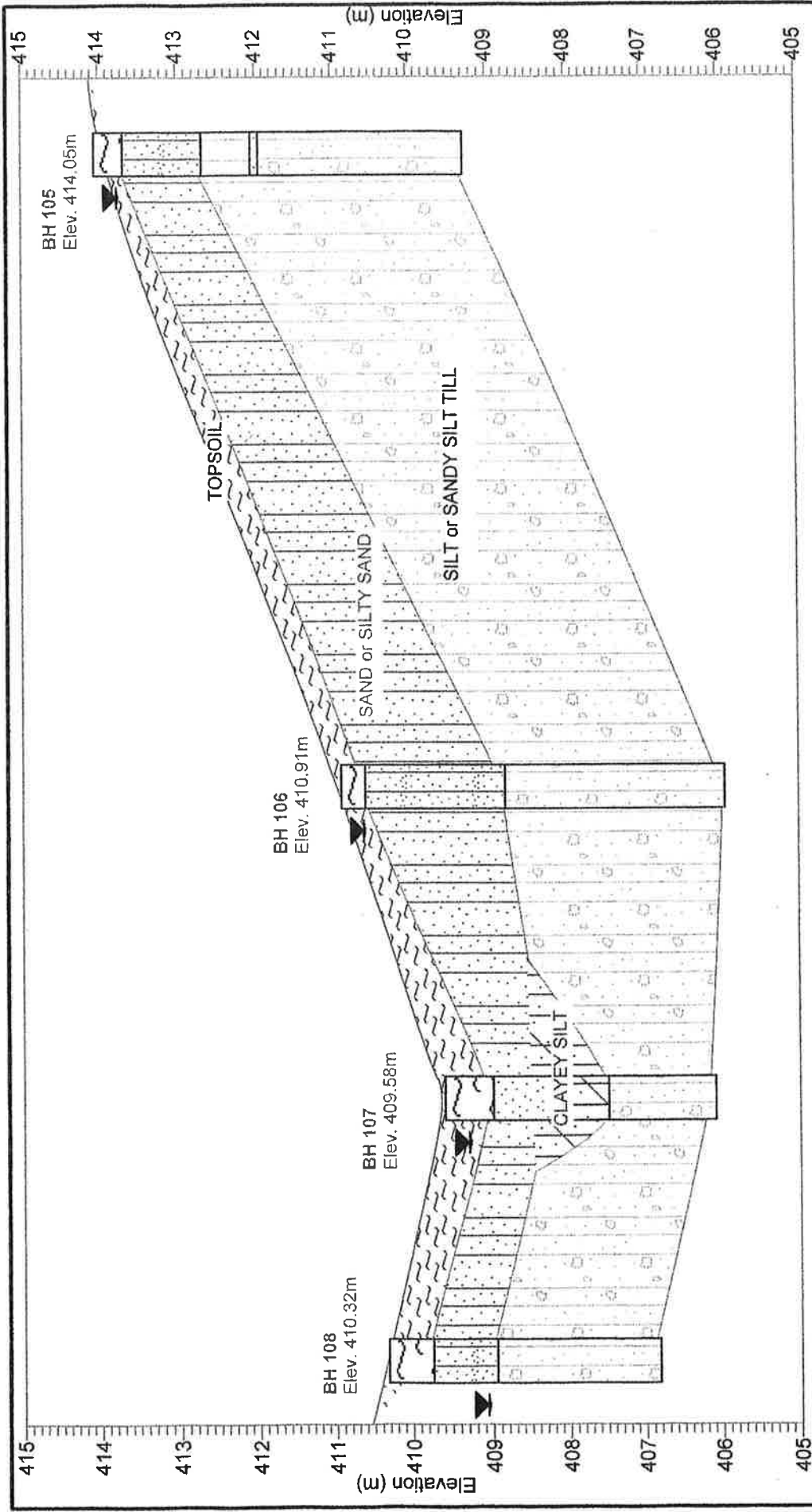

NOTE: Water levels shown were measured on Feb. 8, 2006. Please refer to Section 4.7 of this report for additional water levels.

 <p>1011 Industrial Cres., Unit 1 St. Clements, Ontario</p>	<p>Project: ANLEY SUBDIVISION</p>
	<p>Project Number: 06-004 Location: Elora, Ontario Drawn By: JS Date: February 2006</p>

APPENDIX C

GRAIN SIZE ANALYSES

Particle Size Distribution Report

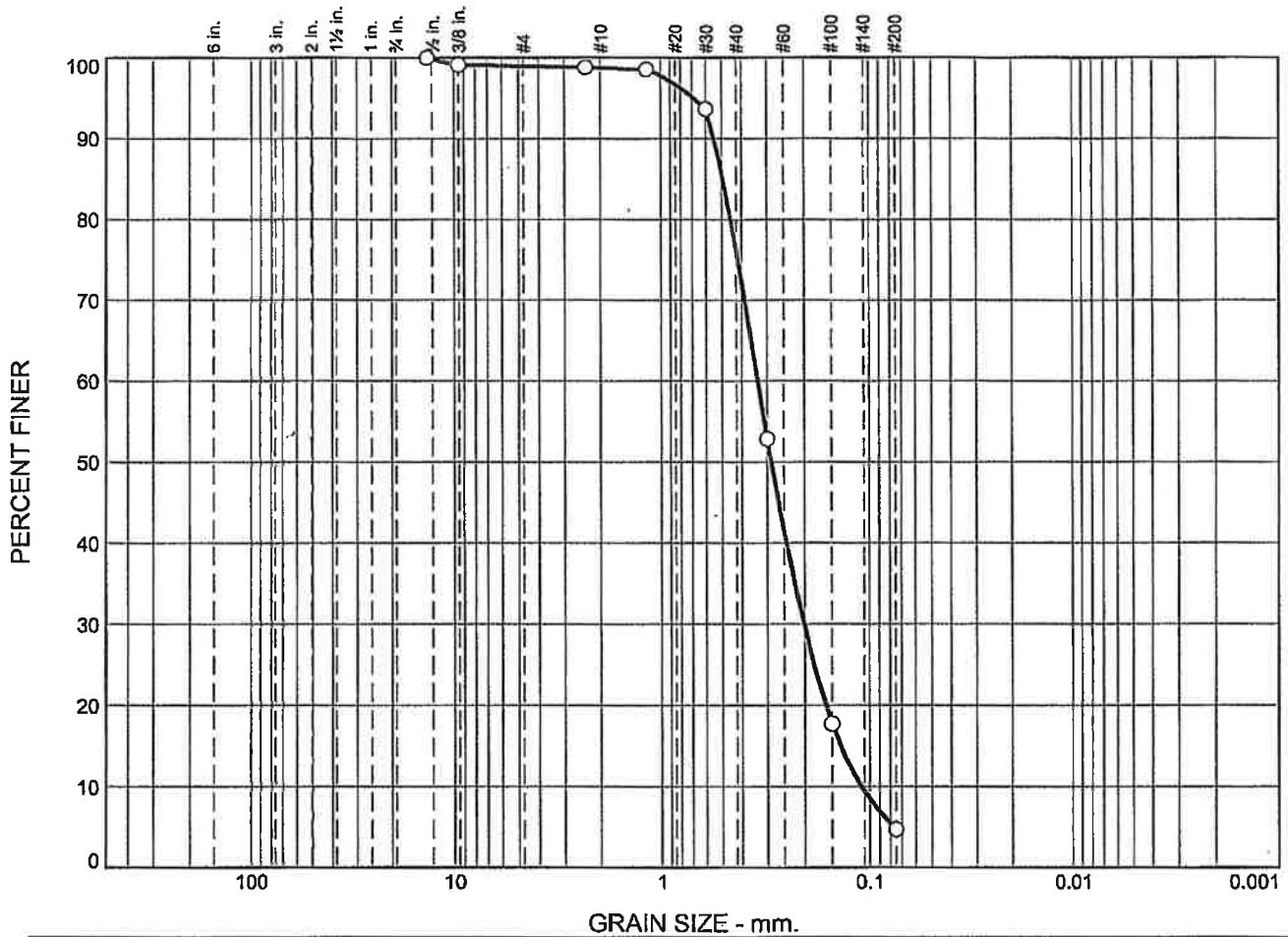

	% Cobbles	% Gravel		% Sand			% Fines	
		Coarse	Fine	Coarse	Medium	Fine	Silt	Clay
○	0.0	0.0	1.0	0.2	22.7	71.4	4.7	

SOIL DATA					
SYMBOL	SOURCE	SAMPLE NO.	DEPTH (ft.)	Material Description	USCS
○	BH102 - SS4	1	3.05-3.51m	Sand, trace silt, trace gravel	SP
				Tested by CMT - January 27, 2006	

CMT Engineering Inc.

St. Clements, ON

Client: Ainley Subdivision

Project: Township of Centre Wellington
Elora, Ontario

Project No.: 06-004

Figure 1

Particle Size Distribution Report

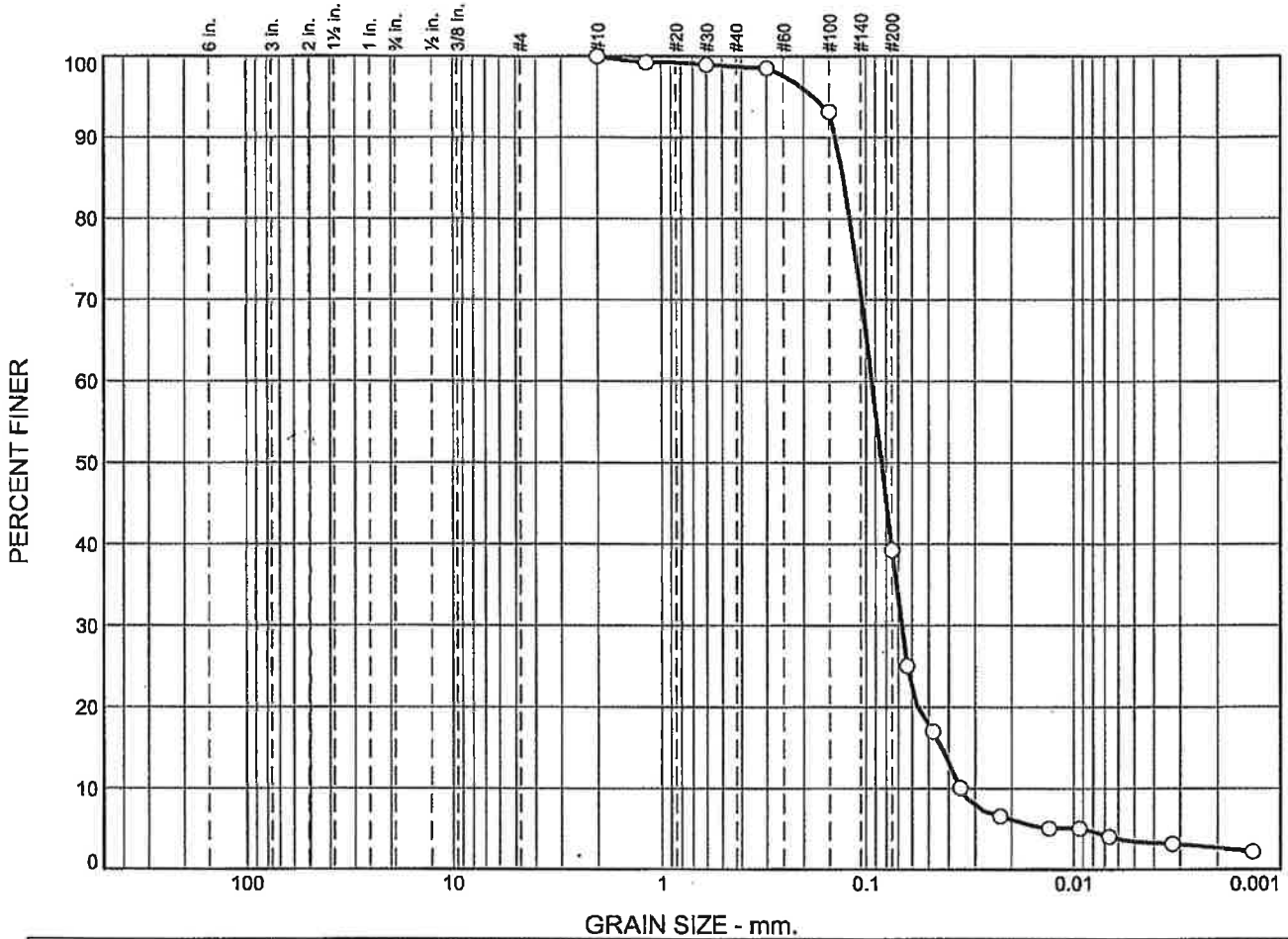

	% Cobbles	% Gravel		% Sand			% Fines	
		Coarse	Fine	Coarse	Medium	Fine	Silt	Clay
○	0.0	0.0	0.0	0.0	1.2	59.5	36.6	2.7

SOIL DATA					
SYMBOL	SOURCE	SAMPLE NO.	DEPTH (ft.)	Material Description	USCS
○	BH103 - SS5	1	4.57-5.03m	Silty sand, trace clay	SM
Tested by CMT - January 27, 2006					

CMT Engineering Inc.

St. Clements, ON

Client: Ainley Subdivision
 Project: Township of Centre Wellington
 Elora, Ontario
 Project No.: 06-004

Figure 2

Particle Size Distribution Report

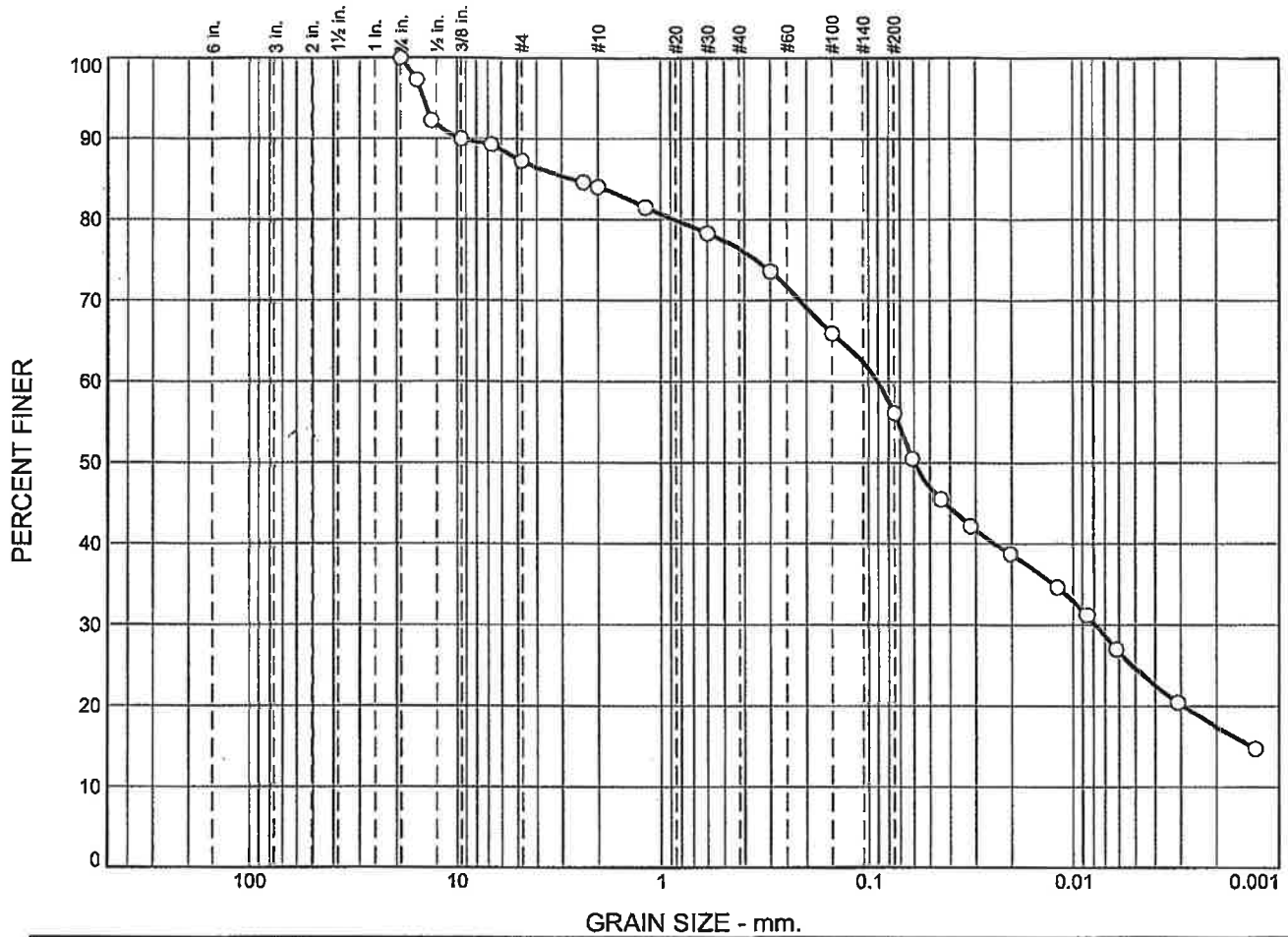

	% Cobbles	% Gravel		% Sand			% Fines	
		Coarse	Fine	Coarse	Medium	Fine	Silt	Clay
○	0.0	0.0	12.8	3.2	7.6	20.3	38.7	17.4

SOIL DATA

SYMBOL	SOURCE	SAMPLE NO.	DEPTH (ft.)	Material Description	USCS
○	BH105 - SS3	1	2.29-2.74m	Sandy silt, some clay, some gravel	ML
				Tested by CMT - January 27, 2006	

CMT Engineering Inc.

St. Clements, ON

Client: Ainley Subdivision

Project: Township of Centre Wellington
Elora, Ontario

Project No.: 06-004

Figure 3

Particle Size Distribution Report

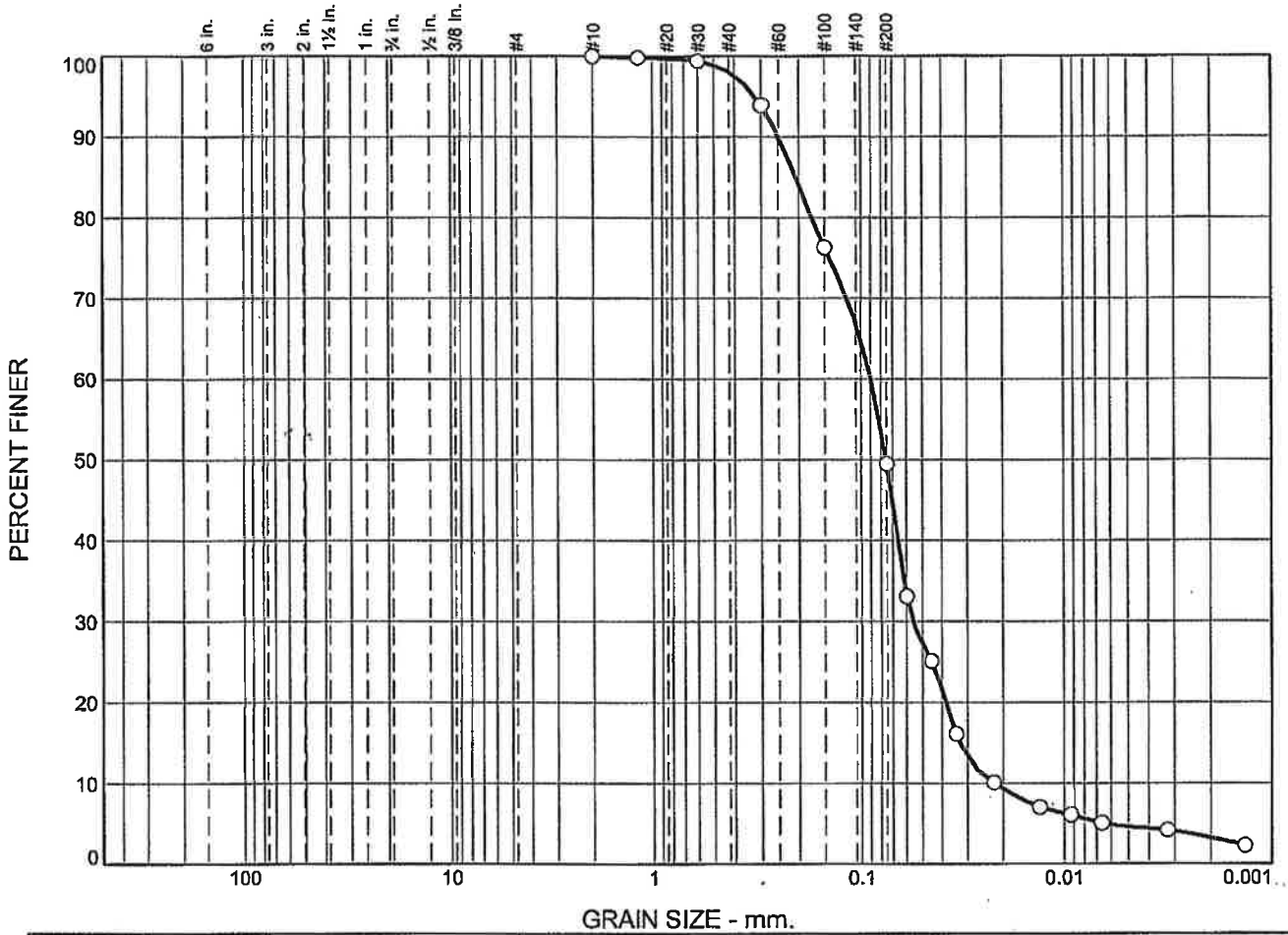

Symbol	% Cobbles	% Gravel		% Sand			% Fines	
		Coarse	Fine	Coarse	Medium	Fine	Silt	Clay
○	0.0	0.0	0.0	0.0	1.9	48.6	46.3	3.2

SOIL DATA					
SYMBOL	SOURCE	SAMPLE NO.	DEPTH (ft.)	Material Description	USCS
○	BH107 - SS3	1	2.29-2.74m	Sand and silt, trace clay	SM
Tested by CMT - January 27, 2006					

CMT Engineering Inc.

St. Clements, ON

Client: Ainley Subdivision

Project: Township of Centre Wellington
Elora, Ontario

Project No.: 06-004

Figure 4

APPENDIX D
LABORATORY PROCTOR TEST

CMT ENGINEERING INC.

LABORATORY PROCTOR TEST

PROJECT NO.: 06-004

PROJECT: Ainley Subdivision

PROJECT LOCATION: Township of Centre Wellington (Elora)

SAMPLED FROM: Borehole 103, BS, depth 1.5 to 2.0 m

DATE SAMPLED/BY: January 25, 2006 by C.D. of CMT Inc.

DATE TESTED/BY: January 26, 2006 by J.S. of CMT Inc.

SOIL TYPE: silt till

REMARKS:

TEST STANDARD:

ASTM D698

PROCEDURE - A B C

ASSUMED SPECIFIC GRAVITY: 2.65

MAXIMUM DRY DENSITY: 2.085 t/m³

OPTIMUM MOISTURE CONTENT: 8.3%

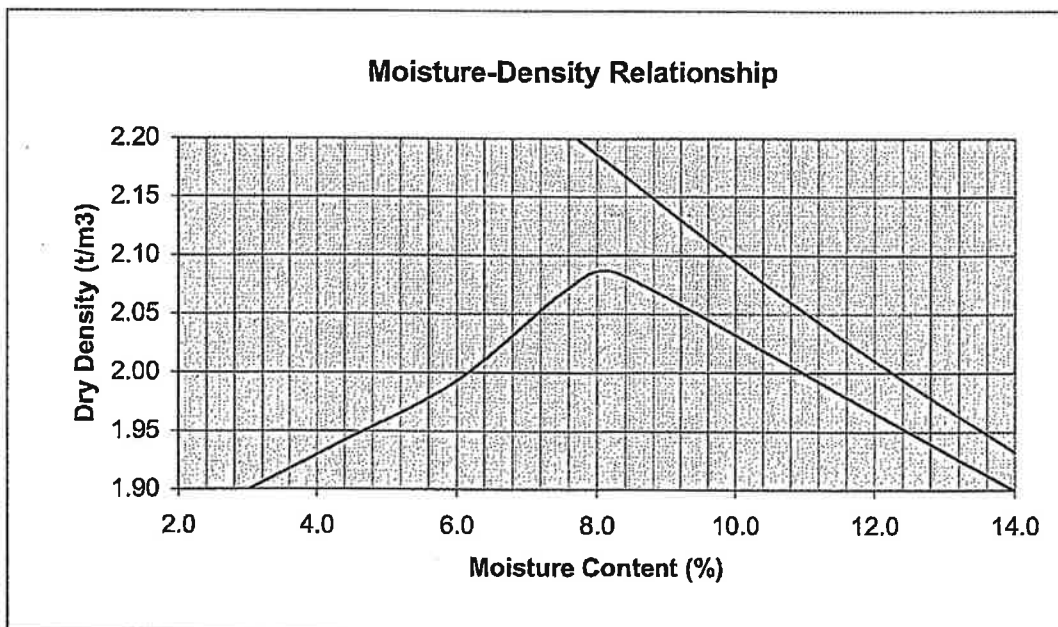

APPENDIX E

WELL RECORD

Instructions for Completing Form

- For use in the Province of Ontario only. This document is a permanent legal document. Please retain for future reference.
- All Sections must be completed in full to avoid delays in processing. Further instructions and explanations are available on the back of this form.
- Questions regarding completing this application can be directed to the Water Well Management Coordinator at 416-235-8203.
- All metre measurements shall be reported to 1/10th of a metre.
- Please print clearly in blue or black ink only.

Well Owner's Information and Location of Well Information						Ministry Use Only		
First Name James		Last Name Keating		Mailing Address (Street Number/Name, RR, Lot, Concession) Matheson St.		MUN	CON	LOT
County/District/Municipality		Township/City/Town/Village Elera		Province Ontario	Postal Code	Telephone Number (include area code)		
Address of Well Location (County/District/Municipality) Gerric Rd.				Township Center Wellington	Lot 17-18	Concession 12		
RR#/Street Number/Name				City/Town/Village Elera	Site/Compartment/Block/Tract etc.			
GPS Reading	NAD 83	Zone	Easting N058214	Northing	Unit Make/Model	Mode of Operation: <input type="checkbox"/> Undifferentiated <input type="checkbox"/> Averaged <input type="checkbox"/> Differentiated, specify		

Log of Overburden and Bedrock Materials (see instructions)

General Colour	Most common material	Other Materials	General Description	Depth From	Metres To
Brown	SILT TILL			0	1.5
Brown	SILT SAND			1.5	4.5

Hole Diameter Depth Metres Diameter Centimetres From To 0 4.5 72		Construction Record Inside diam centimetres Material Well thickness centimetres Depth Metres From To 4 <input checked="" type="checkbox"/> Plastic <input type="checkbox"/> Concrete 0 1.5 <input type="checkbox"/> Steel <input type="checkbox"/> Fibreglass <input type="checkbox"/> Galvanized Screen Outside diam Slot No 4 1.5 4.5 <input type="checkbox"/> Galvanized No Casing or Screen <input type="checkbox"/> Open hole				Test of Well Yield Pumping test method Draw Down Recovery Time min Water Level Metres Time min Water Level Metres Pump intake set at (metres) Static Level Pumping rate (litres/min) 1 1 Duration of pumping hrs + min 2 2 Final water level and of pumping metres 3 3 Recommended pump type <input type="checkbox"/> Shallow <input type="checkbox"/> Deep Recommended pump depth metres 4 4 Recommended pump rate (litres/min) 10 10 15 15 If flowing give rate (litres/min) 20 20 25 25 If pumping discontinued, give reason. 30 30 40 40 50 50 60 60			
Water Record Water found at Metres Kind of Water <input type="checkbox"/> m <input type="checkbox"/> Fresh <input type="checkbox"/> Sulphur <input type="checkbox"/> Gas <input type="checkbox"/> Salty <input type="checkbox"/> Minerals Other: <input type="checkbox"/> m <input type="checkbox"/> Fresh <input type="checkbox"/> Sulphur <input type="checkbox"/> Gas <input type="checkbox"/> Salty <input type="checkbox"/> Minerals Other: <input type="checkbox"/> m <input type="checkbox"/> Fresh <input type="checkbox"/> Sulphur <input type="checkbox"/> Gas <input type="checkbox"/> Salty <input type="checkbox"/> Minerals Other: After test of well yield, water was <input type="checkbox"/> Clear and sediment free <input type="checkbox"/> Other, specify Chlorinated <input type="checkbox"/> Yes <input type="checkbox"/> No		Plugging and Sealing Record <input type="checkbox"/> Annular space <input type="checkbox"/> Abandonment Depth set at - Metres Material and type (benionite slurry, neat cement slurry) etc. Volume Placed (cubic metres) From To 0 1 Bentonite Pellets 100 Lts 1 4.5 #3 Well Sand 300 Lts				Location of Well In diagram below show distances of well from road, lot line, and building. Indicate north by arrow. Woods Farm Field Gerric Rd			
Method of Construction <input type="checkbox"/> Cable Tool <input type="checkbox"/> Rotary (air) <input type="checkbox"/> Diamond <input type="checkbox"/> Digging <input checked="" type="checkbox"/> Rotary (conventional) <input type="checkbox"/> Air percussion <input type="checkbox"/> Jetting <input type="checkbox"/> Other <input type="checkbox"/> Rotary (reverse) <input type="checkbox"/> Boring <input type="checkbox"/> Drilling		Water Use <input type="checkbox"/> Domestic <input type="checkbox"/> Industrial <input type="checkbox"/> Public Supply <input type="checkbox"/> Other <input type="checkbox"/> Stock <input type="checkbox"/> Commercial <input type="checkbox"/> Not used <input type="checkbox"/> Irrigation <input type="checkbox"/> Municipal <input type="checkbox"/> Cooling & air conditioning				Audit No. Z 39731 Date Well Completed YYY MM DD 2006 10 25 Was the well owner's information package delivered? <input type="checkbox"/> Yes <input checked="" type="checkbox"/> No 2006 10 21			
Final Status of Well <input type="checkbox"/> Water Supply <input type="checkbox"/> Recharge well <input type="checkbox"/> Unfinished <input type="checkbox"/> Abandoned, (Other) <input checked="" type="checkbox"/> Observation well <input type="checkbox"/> Abandoned, insufficient supply <input type="checkbox"/> Dewatering <input checked="" type="checkbox"/> Test Hole <input type="checkbox"/> Abandoned, poor quality <input type="checkbox"/> Replacement well		Well Contractor/Technician Information Name of Well Contractor Business Address (street name, number, city etc.) Andrew Dilling Inc 7738 C-25 Lewis Rd. Suelph ON N1H 1E9 Name of Well Technician (last name, first name) Well Technician's Licence No. Henry Matheson 7-3305 Signature of Technician/Contractor Date Submitted YYY MM DD [Signature] 2006 10 21				Ministry Use Only Data Source (Contractor) Date Received YYY MM DD Date of Inspection YYY MM DD Remarks Well Record Number			



APPENDIX B
GROUNDWATER ELEVATION MONITORING
CMT ENGINEERING INC.
OCTOBER 12, 2012



CMT Engineering Inc.
CONSULTING ENGINEERS
1011 Industrial Crescent, Unit 1
St. Clements, Ontario N0B 2M0
Tel: 519-699-5775
Fax: 519-699-4664
www.cmtinc.net



(411009)

July 4, 2013

06-004.L71

Gamsby and Mannerow Limited
650 Woodlawn Road West
Block C, Unit 1
Guelph, Ontario
N1K 1B8

Dear Sir:

**Re: Groundwater Monitoring
Ainley Subdivision
Elora, Ontario**

Attached is a current summary of the water level measurements for the above-referenced site. The graphs have been amended to include total monthly precipitation as recorded at the Environment Canada Fergus MOE Weather Station.

I trust this information meets with your present requirements. Should you have any questions, please do not hesitate to contact our office.

Yours very truly,

A handwritten signature in black ink, appearing to read 'Tim Salter'.

Tim Salter, C.E.T.

ks

Encl - Water Level Measurements

WATER LEVEL MEASUREMENTSAINLEY SUBDIVISION
ELORA, ONTARIO

Borehole No.	Ground Surface Elevation (m)	Water Elevation (m) Feb 8/06	Water Elevation (m) Feb 20/06	Water Elevation (m) Mar 9/06	Water Elevation (m) Mar 25/06	Water Elevation (m) Mar 29/06	Water Elevation (m) Apr 28/06	Water Elevation (m) June 6/06	Water Elevation (m) July 8/06	Water Elevation (m) Aug 7/06	Water Elevation (m) Sept 7/06
101	413.64	413.07	413.11	412.83	412.96	--	412.94	412.59	411.70	411.34	411.00
102	414.37	411.57	411.96	411.91	412.48	--	412.43	412.12	411.78	411.43	411.14
103	414.89	412.65	412.98	412.88	412.77	--	412.76	411.55	410.95	410.43	410.31
104	410.93	410.36	410.60	410.17	410.66	--	410.69	410.15	409.15	408.71	408.52
105	414.05	414.05	414.07 (F)	414.15 (F)	414.15 (F)	414.68	413.44	412.86	412.27	412.06	411.59
106	410.91	410.67	410.86 (F)	410.93 (F)	410.75	--	410.54	410.36	409.93	409.89	409.39
107	409.58	409.43	409.06 (F)	409.12 (F)	409.41	--	409.42	409.03	408.11	408.00	407.63
108	410.32	409.06	409.21	408.82	409.01	--	408.99	408.43	407.94	407.76	407.11

*(F) = Frozen

WATER LEVEL MEASUREMENTS**AINLEY SUBDIVISION
ELORA, ONTARIO**

Borehole No.	Ground Surface Elevation (m)	Water Elevation (m) Oct 6/06	Water Elevation (m) Nov 11/06	Water Elevation (m) Dec 7/06	Water Elevation (m) Jan 9/07	Water Elevation (m) Feb 12/07	Water Elevation (m) Mar 8/07	Water Elevation (m) Apr 10/07	Water Elevation (m) May 12/07	Water Elevation (m) June 11/07	Water Elevation (m) July 11/07
101	413.64	410.83	412.67	412.97	413.03	412.11	411.61	413.02	412.75	411.87	411.42
102	414.37	411.00	411.25	411.71	411.99	411.69	411.45	412.14	411.96	411.67	411.38
103	414.89	410.36	411.10	411.91	412.27	411.05	410.66	412.50	411.59	410.97	410.54
104	410.93	408.71	409.13	409.45	409.65	409.12	408.96	409.78	409.39	409.24	408.92
105	414.05	411.95	413.94	413.71	413.90	412.95	412.65	413.72	413.29	412.51	412.11
106	410.91	410.13	410.74	410.57	410.59	410.28	410.22	410.55	410.50	410.07	409.59
107	409.58	408.28	408.94	409.11	409.16	408.60	408.43	409.25	409.01	408.24	407.71
108	410.32	407.62	408.21	408.48	408.57	408.07	407.93	408.69	408.36	407.96	407.57

*(F) = Frozen

WATER LEVEL MEASUREMENTSAINLEY SUBDIVISION
ELORA, ONTARIO

Borehole No.	Ground Surface Elevation (m)	Water Elevation (m) Aug 15/07	Water Elevation (m) Sept 13/07	Water Elevation (m) Oct 12/07	Water Elevation (m) Nov 8/07	Water Elevation (m) Dec 11/07	Water Elevation (m) Jan 15/08	Water Elevation (m) Feb 12/08	Water Elevation (m) Mar 8/08	Water Elevation (m) Apr 13/08	Water Elevation (m) May 8/08
101	413.64	411.01	410.72	410.50	410.35	410.33	412.73	412.92	413.00	413.19	413.05
102	414.37	411.13	410.98	410.87	410.81	410.77	411.26	411.53	411.80	412.92	412.46
103	414.89	410.34	410.36	410.36	410.36	410.36	411.29	411.74	412.03	413.40	412.50
104	410.93	408.73	408.61	408.57	408.58	408.76	409.70	409.66	409.81	410.70	410.35
105	414.05	411.67	411.34	411.22	411.22	411.22	414.00	414.11	414.10 frozen	413.99	413.71
106	410.91	409.22	408.99	408.89	408.89	409.44	410.63	410.61	410.64	410.77	410.69
107	409.58	407.49	407.40	407.43	407.52	407.91	409.20	409.05	409.10	409.52	409.35
108	410.32	407.36	407.37	407.37	407.37	407.52	408.52	408.50	408.57	409.19	408.89

*(F) = Frozen

WATER LEVEL MEASUREMENTSAINLEY SUBDIVISION
ELORA, ONTARIO

Borehole No.	Ground Surface Elevation (m)	Water Elevation (m) June 10/08	Water Elevation (m) July 8/08	Water Elevation (m) Aug 1/08	Water Elevation (m) Sept 10/08	Water Elevation (m) Oct 8/08	Water Elevation (m) Nov 17/08	Water Elevation (m) Dec 17/08	Water Elevation (m) Jan 23/09	Water Elevation (m) Feb 20/09	Water Elevation (m) Mar 18/09
101	413.64	412.58	412.60	412.55	411.67	410.86	413.08	413.135	412.725	412.960	413.053
102	414.37	412.13	412.06	411.95	411.57	410.30	411.52	411.979	412.147	412.419	412.772
103	414.89	411.53	411.60	411.56	410.86	410.64	412.14	412.746	411.796	412.600	413.046
104	410.93	409.86	409.71	409.76	409.34	408.18	409.98	410.183	409.902	410.238	410.670
105	414.05	412.96	412.87	412.93	412.26	411.60	413.99	413.969	413.221	414.066 (F)	414.070 (F)
106	410.91	410.83	410.24	410.36	410.28	409.04	410.78	410.67	410.567	411.010 (F)	410.963 (F)
107	409.58	409.00	408.72	408.86	408.40	407.36	409.24	409.249	409.009	409.246	409.502
108	410.32	408.33	408.20	408.29	407.95	406.82	408.51	408.662	408.359	408.651	408.948

*(F) = Frozen

WATER LEVEL MEASUREMENTSAINLEY SUBDIVISION
ELORA, ONTARIO

Borehole No.	Ground Surface Elevation (m)	Water Elevation (m) Apr 21/09	Water Elevation (m) May 21/09	Water Elevation (m) June 26/09	Water Elevation (m) July 22/09	Water Elevation (m) Aug 27/09	Water Elevation (m) Sept 29/09	Water Elevation (m) Oct 30/09	Water Elevation (m) Dec 7/09	Water Elevation (m) Jan 5/10	Water Elevation (m) Feb 9/10
101	413.64	412.95	412.77	411.93	411.54	411.27	411.16	411.72	412.26	412.04	411.55
102	414.37	412.79	412.43	411.93	411.63	411.28	411.11	411.11	411.15	411.19	411.06
103	414.89	412.88	412.03	411.17	410.80	410.44	410.36	410.57	410.91	410.83	410.47
104	410.93	410.45	410.11	409.61	409.35	409.15	409.04	409.23	409.41	409.36	409.19
105	414.05	413.45	412.98	412.21	411.93	412.05	412.12	412.97	413.25	413.05	412.72
106	410.91	410.55	410.43	410.08	409.87	409.90	410.08	410.33	410.54	410.33	410.22
107	409.58	409.35	409.12	408.62	408.13	407.97	407.97	408.47	408.85	408.81	408.60
108	410.32	408.86	408.51	408.08	407.84	407.66	407.52	407.79	408.01	408.05	407.93

*(F) = Frozen

WATER LEVEL MEASUREMENTSAINLEY SUBDIVISION
ELORA, ONTARIO

Borehole No.	Ground Surface Elevation (m)	Water Elevation (m) Mar 2/10	Water Elevation (m) Apr 17/10	Water Elevation (m) May 11/10	Water Elevation (m) June 1/10	Water Elevation (m) June 29/10	Water Elevation (m) Aug 5/10	Water Elevation (m) Sept 22/10	Water Elevation (m) Oct 22/10	Water Elevation (m) Nov 9/10	Water Elevation (m) Dec 6/10
101	413.64	411.31	412.70	412.87	412.31	412.92	411.66	410.97	410.83	410.84	411.37
102	414.37	411.01	411.60	411.65	411.64	411.73	411.43	411.09	410.58	410.89	410.93
103	414.89	410.37	411.53	411.73	411.21	411.80	410.76	dry	dry	dry	dry
104	410.93	409.14	409.82	410.09	409.51	409.90	409.17	408.85	408.86	408.89	409.20
105	414.05	412.47	413.22	413.36	412.67	413.37	412.16	411.49	411.75	412.25	413.30
106	410.91	410.12	410.49	410.55	410.15	410.53	409.90	409.50	409.60	409.75	410.33
107	409.58	408.38	409.12	409.34	408.69	409.23	408.06	407.69	407.80	407.88	408.72
108	410.32	407.81	408.43	408.70	408.16	408.42	407.78	407.41	407.44	407.51	407.59

*(F) = Frozen

WATER LEVEL MEASUREMENTSAINLEY SUBDIVISION
ELORA, ONTARIO

Borehole No.	Ground Surface Elevation (m)	Water Elevation (m) Jan 11/11	Water Elevation (m) Feb 19/11	Water Elevation (m) Mar 31/11	Water Elevation (m) July 19/11	Water Elevation (m) Sept 30/11	Water Elevation (m) Dec 7/11	Water Elevation (m) Feb 10/12	Water Elevation (m) Apr 4/12	Water Elevation (m) June 27/12	Water Elevation (m) Aug 1/12
101	413.64	412.24	412.62	413.09	412.33	411.51	413.21	412.91	412.67	411.22	410.84
102	414.37	411.10	411.09	dry	412.09	411.22	412.23	412.16	412.07	411.28	411.05
103	414.89	410.76	411.02	dry	411.42	410.49	413.25	412.28	411.73	410.45	dry
104	410.93	409.27	409.20	410.05	409.54	409.24	410.45	409.95	409.86	409.06	408.73
105	414.05	413.52	413.93	413.86	412.53	412.83	413.93	413.53	412.99	411.75	411.30
106	410.91	410.37	410.61	410.66	410.09	410.23	410.73	410.52	410.46	409.64	409.17
107	409.58	408.85	408.70	409.29	408.21	408.18	409.44	409.14	409.10	407.93	407.52
108	410.32	408.02	407.89	408.66	407.92	407.73	408.92	408.53	408.38	407.69	dry

*(F) = Frozen

WATER LEVEL MEASUREMENTS

**AINLEY SUBDIVISION
ELORA, ONTARIO**

Borehole No.	Ground Surface Elevation (m)	Water Elevation (m) Oct 11/12	Water Elevation (m) Dec 11/12	Water Elevation (m) Mar 9/13	Water Elevation (m) May 3/13	Water Elevation (m) July 3/13	Water Elevation (m)	Water Elevation (m)	Water Elevation (m)	Water Elevation (m)
101	413.64	410.48	412.25	412.19	412.94	412.74				
102	414.37	410.81	411.18	411.42	412.52	412.08				
103	414.89	dry	410.87	411.00	412.71	411.74				
104	410.93	408.69	409.36	408.32	410.21	409.94				
105	414.05	dry	413.48	413.12	413.38	412.89				
106	410.91	409.26	410.53	410.40	410.55	410.44				
107	409.58	407.61	408.91	408.84	409.32	409.21				
108	410.32	dry	418.10	408.09	408.74	408.50				

*(F) = Frozen



APPENDIX C
STORMWATER MANAGEMENT ANALYSIS

```

"                                     UnconEx_2yr
"                                     ----->
" MIDUSS Output ----->
" MIDUSS version                      Version 2.25 rev. 473"
" MIDUSS created                      Sunday, February 07, 2010"
" 10 Units used:                      ie METRIC"
" Job folder:                         w:\Kitchener\411-2011\411009\Design Data\
"                                     Modelling Files\2019-02-15\Uncontrolled"
" Output filename:                    UnconEx_2yr.out"
" Licensee name:                      gmbp"
" Company                             Hewlett-Packard Company"
" Date & Time last used:              2/15/2019 at 1:27:44 PM"
" 31 TIME PARAMETERS"
" 5.000 Time Step"
" 180.000 Max. Storm length"
" 3600.000 Max. Hydrograph"
" 32 STORM Chicago storm"
" 1 Chicago storm"
" 695.050 Coefficient A"
" 6.387 Constant B"
" 0.793 Exponent C"
" 0.380 Fraction R"
" 180.000 Duration"
" 1.000 Time step multiplier"
" Maximum intensity                    93.293 mm/hr"
" Total depth                          33.014 mm"
" 6 002hyd Hydrograph extension used in this file"
" 33 CATCHMENT 30"
" 1 Triangular SCS"
" 1 Equal length"
" 1 SCS method"
" 30 Catchment 30"
" 0.000 % Impervious"
" 0.220 Total Area"
" 20.000 Flow length"
" 2.000 Overland slope"
" 0.220 Pervious Area"
" 20.000 Pervious length"
" 2.000 Pervious slope"
" 0.000 Impervious Area"
" 20.000 Impervious length"
" 2.000 Impervious slope"
" 0.250 Pervious Manning 'n'"
" 74.000 Pervious SCS Curve No."
" 0.155 Pervious Runoff coefficient"
" 0.100 Pervious Ia/S coefficient"
" 8.924 Pervious Initial abstraction"
" 0.015 Impervious Manning 'n'"
" 98.000 Impervious SCS Curve No."
" 0.000 Impervious Runoff coefficient"
" 0.100 Impervious Ia/S coefficient"
" 0.518 Impervious Initial abstraction"
" 0.003 0.000 0.000 0.000 c.m/sec"
" Catchment 30 Pervious Impervious Total Area "
" Surface Area 0.220 0.000 0.220 hectare"
" Time of concentration 23.304 1.868 23.304 minutes"
" Time to Centroid 130.781 88.659 130.781 minutes"
" Rainfall depth 33.014 33.014 33.014 mm"
" Rainfall volume 72.63 0.00 72.63 c.m"
" Rainfall losses 27.898 5.363 27.898 mm"
" Runoff depth 5.116 27.651 5.116 mm"
" Runoff volume 11.26 0.00 11.26 c.m"
" Runoff coefficient 0.155 0.000 0.155 "
" Maximum flow 0.003 0.000 0.003 c.m/sec"
" 40 HYDROGRAPH Add Runoff "

```

```

UnconEx_2yr
"      4  Add Runoff "
"      0.003      0.003      0.000      0.000"
" 40  HYDROGRAPH Copy to Outflow"
"      8  Copy to Outflow"
"      0.003      0.003      0.003      0.000"
" 40  HYDROGRAPH Combine 2"
"      6  Combine "
"      2  Node #"
"      To Walser Street"
"      Maximum flow      0.003      c.m/sec"
"      Hydrograph volume      11.255      c.m"
"      0.003      0.003      0.003      0.003"
" 40  HYDROGRAPH Start - New Tributary"
"      2  Start - New Tributary"
"      0.003      0.000      0.003      0.003"
" 33  CATCHMENT 10"
"      1  Triangular SCS"
"      1  Equal length"
"      1  SCS method"
"      10  Catchment 10"
"      0.000  % Impervious"
"      7.760  Total Area"
"      150.000  Flow length"
"      2.000  Overland Slope"
"      7.760  Pervious Area"
"      150.000  Pervious length"
"      2.000  Pervious slope"
"      0.000  Impervious Area"
"      150.000  Impervious length"
"      2.000  Impervious slope"
"      0.250  Pervious Manning 'n'"
"      74.000  Pervious SCS Curve No."
"      0.155  Pervious Runoff coefficient"
"      0.100  Pervious Ia/S coefficient"
"      8.924  Pervious Initial abstraction"
"      0.015  Impervious Manning 'n'"
"      98.000  Impervious SCS Curve No."
"      0.000  Impervious Runoff coefficient"
"      0.100  Impervious Ia/S coefficient"
"      0.518  Impervious Initial abstraction"
"      0.044      0.000      0.003      0.003 c.m/sec"
"      Catchment 10      Pervious      Impervious      Total Area "
"      Surface Area      7.760      0.000      7.760      hectare"
"      Time of concentration      78.068      6.258      78.068      minutes"
"      Time to Centroid      195.540      95.197      195.540      minutes"
"      Rainfall depth      33.014      33.014      33.014      mm"
"      Rainfall volume      2561.88      0.00      2561.88      c.m"
"      Rainfall losses      27.894      5.228      27.894      mm"
"      Runoff depth      5.120      27.786      5.120      mm"
"      Runoff volume      397.31      0.00      397.31      c.m"
"      Runoff coefficient      0.155      0.000      0.155      "
"      Maximum flow      0.044      0.000      0.044      c.m/sec"
" 40  HYDROGRAPH Add Runoff "
"      4  Add Runoff "
"      0.044      0.044      0.003      0.003"
" 33  CATCHMENT 11"
"      1  Triangular SCS"
"      1  Equal length"
"      1  SCS method"
"      11  Catchment 11"
"      0.000  % Impervious"
"      0.130  Total Area"
"      40.000  Flow length"

```

UnconEx_2yr

```

"      2.000  Overland Slope"
"      0.130  Pervious Area"
"     40.000  Pervious length"
"      2.000  Pervious slope"
"      0.000  Impervious Area"
"     40.000  Impervious length"
"      2.000  Impervious slope"
"      0.250  Pervious Manning 'n'"
"     74.000  Pervious SCS Curve No."
"      0.155  Pervious Runoff coefficient"
"      0.100  Pervious Ia/S coefficient"
"      8.924  Pervious Initial abstraction"
"      0.015  Impervious Manning 'n'"
"     98.000  Impervious SCS Curve No."
"      0.000  Impervious Runoff coefficient"
"      0.100  Impervious Ia/S coefficient"
"      0.518  Impervious Initial abstraction"
"          0.001  0.044  0.003  0.003 c.m/sec"
"      Catchment 11  Pervious  Impervious  Total Area  "
"      Surface Area  0.130  0.000  0.130  hectare"
"      Time of concentration  35.323  2.832  35.323  minutes"
"      Time to Centroid  144.986  90.217  144.986  minutes"
"      Rainfall depth  33.014  33.014  33.014  mm"
"      Rainfall volume  42.92  0.00  42.92  c.m"
"      Rainfall losses  27.897  5.467  27.897  mm"
"      Runoff depth  5.117  27.547  5.117  mm"
"      Runoff volume  6.65  0.00  6.65  c.m"
"      Runoff coefficient  0.155  0.000  0.155  "
"      Maximum flow  0.001  0.000  0.001  c.m/sec"
" 40  HYDROGRAPH Add Runoff "
"      4  Add Runoff "
"          0.001  0.045  0.003  0.003"
" 33  CATCHMENT 40"
"      1  Triangular SCS"
"      1  Equal length"
"      1  SCS method"
"      40  Catchment 40"
"      0.000  % Impervious"
"      7.120  Total Area"
"     60.000  Flow length"
"      2.000  Overland Slope"
"      7.120  Pervious Area"
"     60.000  Pervious length"
"      2.000  Pervious slope"
"      0.000  Impervious Area"
"     60.000  Impervious length"
"      2.000  Impervious slope"
"      0.250  Pervious Manning 'n'"
"     74.000  Pervious SCS Curve No."
"      0.155  Pervious Runoff coefficient"
"      0.100  Pervious Ia/S coefficient"
"      8.924  Pervious Initial abstraction"
"      0.015  Impervious Manning 'n'"
"     98.000  Impervious SCS Curve No."
"      0.000  Impervious Runoff coefficient"
"      0.100  Impervious Ia/S coefficient"
"      0.518  Impervious Initial abstraction"
"          0.060  0.045  0.003  0.003 c.m/sec"
"      Catchment 40  Pervious  Impervious  Total Area  "
"      Surface Area  7.120  0.000  7.120  hectare"
"      Time of concentration  45.052  3.611  45.051  minutes"
"      Time to Centroid  156.495  91.497  156.495  minutes"
"      Rainfall depth  33.014  33.014  33.014  mm"

```

		UnconEx_2yr			
"	Rainfall volume	2350.59	0.00	2350.59	c.m"
"	Rainfall losses	27.895	5.642	27.895	mm"
"	Runoff depth	5.119	27.372	5.119	mm"
"	Runoff volume	364.45	0.00	364.45	c.m"
"	Runoff coefficient	0.155	0.000	0.155	"
"	Maximum flow	0.060	0.000	0.060	c.m/sec"
40	HYDROGRAPH Add Runoff "				
"	4 Add Runoff "				
"	0.060 0.099 0.003 0.003"				
40	HYDROGRAPH Copy to Outflow"				
"	8 Copy to Outflow"				
"	0.060 0.099 0.099 0.003"				
40	HYDROGRAPH Combine 2"				
"	6 Combine "				
"	2 Node #"				
"	To Walser Street"				
"	Maximum flow	0.101		c.m/sec"	
"	Hydrograph volume	779.672		c.m"	
"	0.060 0.099 0.099 0.101"				
40	HYDROGRAPH Start - New Tributary"				
"	2 Start - New Tributary"				
"	0.060 0.000 0.099 0.101"				
33	CATCHMENT 20"				
"	1 Triangular SCS"				
"	1 Equal length"				
"	1 SCS method"				
"	20 Catchment 20"				
"	0.000 % Impervious"				
"	6.650 Total Area"				
"	150.000 Flow length"				
"	2.000 Overland Slope"				
"	6.650 Pervious Area"				
"	150.000 Pervious length"				
"	2.000 Pervious slope"				
"	0.000 Impervious Area"				
"	150.000 Impervious length"				
"	2.000 Impervious slope"				
"	0.250 Pervious Manning 'n'"				
"	74.000 Pervious SCS Curve No."				
"	0.155 Pervious Runoff coefficient"				
"	0.100 Pervious Ia/S coefficient"				
"	8.924 Pervious Initial abstraction"				
"	0.015 Impervious Manning 'n'"				
"	98.000 Impervious SCS Curve No."				
"	0.000 Impervious Runoff coefficient"				
"	0.100 Impervious Ia/S coefficient"				
"	0.518 Impervious Initial abstraction"				
"	0.038 0.000 0.099 0.101 c.m/sec"				
"	Catchment 20 Pervious Impervious Total Area "				
"	Surface Area 6.650 0.000 6.650 hectare"				
"	Time of concentration 78.068 6.258 78.068 minutes"				
"	Time to Centroid 195.540 95.197 195.539 minutes"				
"	Rainfall depth 33.014 33.014 33.014 mm"				
"	Rainfall volume 2195.43 0.00 2195.43 c.m"				
"	Rainfall losses 27.894 5.228 27.894 mm"				
"	Runoff depth 5.120 27.786 5.120 mm"				
"	Runoff volume 340.48 0.00 340.48 c.m"				
"	Runoff coefficient 0.155 0.000 0.155 "				
"	Maximum flow 0.038 0.000 0.038 c.m/sec"				
40	HYDROGRAPH Add Runoff "				
"	4 Add Runoff "				
"	0.038 0.038 0.099 0.101"				
33	CATCHMENT 21"				

UnconEx_2yr

```

"      1 Triangular SCS"
"      1 Equal length"
"      1 SCS method"
"     21 Catchment 20"
"    10.000 % Impervious"
"      0.820 Total Area"
"    40.000 Flow length"
"      2.000 Overland slope"
"      0.738 Pervious Area"
"    40.000 Pervious length"
"      2.000 Pervious slope"
"      0.082 Impervious Area"
"    40.000 Impervious length"
"      2.000 Impervious slope"
"      0.250 Pervious Manning 'n'"
"    74.000 Pervious SCS Curve No."
"      0.155 Pervious Runoff coefficient"
"      0.100 Pervious Ia/S coefficient"
"      8.924 Pervious Initial abstraction"
"      0.015 Impervious Manning 'n'"
"    98.000 Impervious SCS Curve No."
"      0.834 Impervious Runoff coefficient"
"      0.100 Impervious Ia/S coefficient"
"      0.518 Impervious Initial abstraction"
"          0.016      0.038      0.099      0.101 c.m/sec"
"      Catchment 21      Pervious      Impervious      Total Area  "
"      Surface Area      0.738      0.082      0.820      hectare"
"      Time of concentration  35.323      2.832      23.162      minutes"
"      Time to Centroid      144.986      90.217      124.487      minutes"
"      Rainfall depth      33.014      33.014      33.014      mm"
"      Rainfall volume      243.64      27.07      270.71      c.m"
"      Rainfall losses      27.897      5.467      25.654      mm"
"      Runoff depth      5.117      27.547      7.360      mm"
"      Runoff volume      37.76      22.59      60.35      c.m"
"      Runoff coefficient      0.155      0.834      0.223      "
"      Maximum flow      0.007      0.015      0.016      c.m/sec"
" 40      HYDROGRAPH Add Runoff "
"      4      Add Runoff "
"          0.016      0.043      0.099      0.101"
" 40      HYDROGRAPH Copy to Outflow"
"      8      Copy to Outflow"
"          0.016      0.043      0.043      0.101"
" 40      HYDROGRAPH Combine 2"
"      6      Combine "
"      2      Node #"
"          To Walser Street"
"      Maximum flow          0.143      c.m/sec"
"      Hydrograph volume      1180.502      c.m"
"          0.016      0.043      0.043      0.143"
" 38      START/RE-START TOTALS 21"
"      3      Runoff Totals on EXIT"
"      Total Catchment area          22.700      hectare"
"      Total Impervious area          0.082      hectare"
"      Total % impervious          0.361"
" 19      EXIT"

```

```

"                                     UnconEx_5yr
"                                     ----->
"      MIDUSS Output
"      MIDUSS version                      Version 2.25 rev. 473"
"      MIDUSS created                      Sunday, February 07, 2010"
"      10  Units used:                      ie METRIC"
"      Job folder:                        w:\Kitchener\411-2011\411009\Design Data\
"                                     Modelling Files\2019-02-15\Uncontrolled"
"      Output filename:                    UnconEx_5yr.out"
"      Licensee name:                      gmbp"
"      Company                            Hewlett-Packard Company"
"      Date & Time last used:              2/15/2019 at 1:32:13 PM"
" 31  TIME PARAMETERS"
"      5.000  Time Step"
"      180.000 Max. Storm length"
"      3600.000 Max. Hydrograph"
" 32  STORM Chicago storm"
"      1  Chicago storm"
"      1459.072 Coefficient A"
"      13.690  Constant B"
"      0.850  Exponent C"
"      0.380  Fraction R"
"      180.000 Duration"
"      1.000  Time step multiplier"
"      Maximum intensity                    113.586  mm/hr"
"      Total depth                          49.792  mm"
"      6 005hyd Hydrograph extension used in this file"
" 33  CATCHMENT 30"
"      1  Triangular SCS"
"      1  Equal length"
"      1  SCS method"
"      30  Catchment 30"
"      0.000  % Impervious"
"      0.220  Total Area"
"      20.000  Flow length"
"      2.000  Overland slope"
"      0.220  Pervious Area"
"      20.000  Pervious length"
"      2.000  Pervious slope"
"      0.000  Impervious Area"
"      20.000  Impervious length"
"      2.000  Impervious slope"
"      0.250  Pervious Manning 'n'"
"      74.000  Pervious SCS Curve No."
"      0.257  Pervious Runoff coefficient"
"      0.100  Pervious Ia/S coefficient"
"      8.924  Pervious Initial abstraction"
"      0.015  Impervious Manning 'n'"
"      98.000  Impervious SCS Curve No."
"      0.000  Impervious Runoff coefficient"
"      0.100  Impervious Ia/S coefficient"
"      0.518  Impervious Initial abstraction"
"      0.009  0.000  0.000  0.000 c.m/sec"
"      Catchment 30  Pervious  Impervious  Total Area  "
"      Surface Area  0.220  0.000  0.220  hectare"
"      Time of concentration  16.417  1.691  16.417  minutes"
"      Time to Centroid  118.292  87.210  118.292  minutes"
"      Rainfall depth  49.792  49.792  mm"
"      Rainfall volume  109.54  0.00  109.54  c.m"
"      Rainfall losses  36.983  5.811  36.983  mm"
"      Runoff depth  12.809  43.981  12.809  mm"
"      Runoff volume  28.18  0.00  28.18  c.m"
"      Runoff coefficient  0.257  0.000  0.257  "
"      Maximum flow  0.009  0.000  0.009  c.m/sec"
" 40  HYDROGRAPH Add Runoff "

```

```

UnconEx_5yr
"      4  Add Runoff "
"      0.009  0.009  0.000  0.000"
" 40  HYDROGRAPH Copy to Outflow"
"      8  Copy to Outflow"
"      0.009  0.009  0.009  0.000"
" 40  HYDROGRAPH Combine 2"
"      6  Combine "
"      2  Node #"
"      To Walser Street"
"      Maximum flow 0.009 c.m/sec"
"      Hydrograph volume 28.179 c.m"
"      0.009  0.009  0.009  0.009"
" 40  HYDROGRAPH Start - New Tributary"
"      2  Start - New Tributary"
"      0.009  0.000  0.009  0.009"
" 33  CATCHMENT 10"
"      1  Triangular SCS"
"      1  Equal length"
"      1  SCS method"
"      10  Catchment 10"
"      0.000  % Impervious"
"      7.760  Total Area"
"      150.000  Flow length"
"      2.000  Overland Slope"
"      7.760  Pervious Area"
"      150.000  Pervious length"
"      2.000  Pervious slope"
"      0.000  Impervious Area"
"      150.000  Impervious length"
"      2.000  Impervious slope"
"      0.250  Pervious Manning 'n'"
"      74.000  Pervious SCS Curve No."
"      0.258  Pervious Runoff coefficient"
"      0.100  Pervious Ia/S coefficient"
"      8.924  Pervious Initial abstraction"
"      0.015  Impervious Manning 'n'"
"      98.000  Impervious SCS Curve No."
"      0.000  Impervious Runoff coefficient"
"      0.100  Impervious Ia/S coefficient"
"      0.518  Impervious Initial abstraction"
"      0.157  0.000  0.009  0.009 c.m/sec"
"      Catchment 10 Pervious Impervious Total Area "
"      Surface Area 7.760 0.000 7.760 hectare"
"      Time of concentration 54.995 5.665 54.994 minutes"
"      Time to Centroid 162.955 92.780 162.955 minutes"
"      Rainfall depth 49.792 49.792 49.792 mm"
"      Rainfall volume 3863.83 0.00 3863.84 c.m"
"      Rainfall losses 36.958 5.466 36.958 mm"
"      Runoff depth 12.834 44.325 12.834 mm"
"      Runoff volume 995.89 0.00 995.90 c.m"
"      Runoff coefficient 0.258 0.000 0.258 "
"      Maximum flow 0.157 0.000 0.157 c.m/sec"
" 40  HYDROGRAPH Add Runoff "
"      4  Add Runoff "
"      0.157  0.157  0.009  0.009"
" 33  CATCHMENT 11"
"      1  Triangular SCS"
"      1  Equal length"
"      1  SCS method"
"      11  Catchment 11"
"      0.000  % Impervious"
"      0.130  Total Area"
"      40.000  Flow length"

```

UnconEx_5yr

```

"      2.000  Overland Slope"
"      0.130  Pervious Area"
"     40.000  Pervious length"
"      2.000  Pervious slope"
"      0.000  Impervious Area"
"     40.000  Impervious length"
"      2.000  Impervious slope"
"      0.250  Pervious Manning 'n'"
"     74.000  Pervious SCS Curve No."
"      0.258  Pervious Runoff coefficient"
"      0.100  Pervious Ia/S coefficient"
"      8.924  Pervious Initial abstraction"
"      0.015  Impervious Manning 'n'"
"     98.000  Impervious SCS Curve No."
"      0.000  Impervious Runoff coefficient"
"      0.100  Impervious Ia/S coefficient"
"      0.518  Impervious Initial abstraction"
"          0.004      0.157      0.009      0.009 c.m/sec"
"      Catchment 11      Pervious      Impervious      Total Area      "
"      Surface Area      0.130      0.000      0.130      hectare"
"      Time of concentration      24.883      2.563      24.883      minutes"
"      Time to Centroid      128.082      88.517      128.082      minutes"
"      Rainfall depth      49.792      49.792      49.792      mm"
"      Rainfall volume      64.73      0.00      64.73      c.m"
"      Rainfall losses      36.970      6.066      36.969      mm"
"      Runoff depth      12.822      43.726      12.822      mm"
"      Runoff volume      16.67      0.00      16.67      c.m"
"      Runoff coefficient      0.258      0.000      0.258      "
"      Maximum flow      0.004      0.000      0.004      c.m/sec"
" 40      HYDROGRAPH Add Runoff "
"      4      Add Runoff "
"          0.004      0.159      0.009      0.009"
" 33      CATCHMENT 40"
"      1      Triangular SCS"
"      1      Equal length"
"      1      SCS method"
"      40      Catchment 40"
"      0.000  % Impervious"
"      7.120  Total Area"
"     60.000  Flow length"
"      2.000  Overland Slope"
"      7.120  Pervious Area"
"     60.000  Pervious length"
"      2.000  Pervious slope"
"      0.000  Impervious Area"
"     60.000  Impervious length"
"      2.000  Impervious slope"
"      0.250  Pervious Manning 'n'"
"     74.000  Pervious SCS Curve No."
"      0.258  Pervious Runoff coefficient"
"      0.100  Pervious Ia/S coefficient"
"      8.924  Pervious Initial abstraction"
"      0.015  Impervious Manning 'n'"
"     98.000  Impervious SCS Curve No."
"      0.000  Impervious Runoff coefficient"
"      0.100  Impervious Ia/S coefficient"
"      0.518  Impervious Initial abstraction"
"          0.209      0.159      0.009      0.009 c.m/sec"
"      Catchment 40      Pervious      Impervious      Total Area      "
"      Surface Area      7.120      0.000      7.120      hectare"
"      Time of concentration      31.736      3.269      31.736      minutes"
"      Time to Centroid      136.024      89.581      136.024      minutes"
"      Rainfall depth      49.792      49.792      49.792      mm"

```

		UnconEx_5yr			
"	Rainfall volume	3545.16	0.00	3545.17	c.m"
"	Rainfall losses	36.968	6.236	36.968	mm"
"	Runoff depth	12.824	43.556	12.824	mm"
"	Runoff volume	913.04	0.00	913.04	c.m"
"	Runoff coefficient	0.258	0.000	0.258	"
"	Maximum flow	0.209	0.000	0.209	c.m/sec"
40	HYDROGRAPH Add Runoff "				
"	4 Add Runoff "				
"	0.209 0.353 0.009 0.009"				
40	HYDROGRAPH Copy to Outflow"				
"	8 Copy to Outflow"				
"	0.209 0.353 0.353 0.009"				
40	HYDROGRAPH Combine 2"				
"	6 Combine "				
"	2 Node #"				
"	To Walser Street"				
"	Maximum flow	0.358		c.m/sec"	
"	Hydrograph volume	1953.787		c.m"	
"	0.209 0.353 0.353 0.358"				
40	HYDROGRAPH Start - New Tributary"				
"	2 Start - New Tributary"				
"	0.209 0.000 0.353 0.358"				
33	CATCHMENT 20"				
"	1 Triangular SCS"				
"	1 Equal length"				
"	1 SCS method"				
"	20 Catchment 20"				
"	0.000 % Impervious"				
"	6.650 Total Area"				
"	150.000 Flow length"				
"	2.000 Overland Slope"				
"	6.650 Pervious Area"				
"	150.000 Pervious length"				
"	2.000 Pervious slope"				
"	0.000 Impervious Area"				
"	150.000 Impervious length"				
"	2.000 Impervious slope"				
"	0.250 Pervious Manning 'n'"				
"	74.000 Pervious SCS Curve No."				
"	0.258 Pervious Runoff coefficient"				
"	0.100 Pervious Ia/S coefficient"				
"	8.924 Pervious Initial abstraction"				
"	0.015 Impervious Manning 'n'"				
"	98.000 Impervious SCS Curve No."				
"	0.000 Impervious Runoff coefficient"				
"	0.100 Impervious Ia/S coefficient"				
"	0.518 Impervious Initial abstraction"				
"	0.135 0.000 0.353 0.358 c.m/sec"				
"	Catchment 20 Pervious Impervious Total Area "				
"	Surface Area 6.650 0.000 6.650 hectare"				
"	Time of concentration 54.995 5.665 54.994 minutes"				
"	Time to Centroid 162.956 92.780 162.955 minutes"				
"	Rainfall depth 49.792 49.792 49.792 mm"				
"	Rainfall volume 3311.14 0.00 3311.15 c.m"				
"	Rainfall losses 36.958 5.466 36.958 mm"				
"	Runoff depth 12.834 44.325 12.834 mm"				
"	Runoff volume 853.44 0.00 853.44 c.m"				
"	Runoff coefficient 0.258 0.000 0.258 "				
"	Maximum flow 0.135 0.000 0.135 c.m/sec"				
40	HYDROGRAPH Add Runoff "				
"	4 Add Runoff "				
"	0.135 0.135 0.353 0.358"				
33	CATCHMENT 21"				

UnconEx_5yr

```

"      1 Triangular SCS"
"      1 Equal length"
"      1 SCS method"
"     21 Catchment 20"
"    10.000 % Impervious"
"      0.820 Total Area"
"    40.000 Flow length"
"      2.000 Overland slope"
"      0.738 Pervious Area"
"    40.000 Pervious length"
"      2.000 Pervious slope"
"      0.082 Impervious Area"
"    40.000 Impervious length"
"      2.000 Impervious slope"
"      0.250 Pervious Manning 'n'"
"    74.000 Pervious SCS Curve No."
"      0.258 Pervious Runoff coefficient"
"      0.100 Pervious Ia/S coefficient"
"      8.924 Pervious Initial abstraction"
"      0.015 Impervious Manning 'n'"
"    98.000 Impervious SCS Curve No."
"      0.878 Impervious Runoff coefficient"
"      0.100 Impervious Ia/S coefficient"
"      0.518 Impervious Initial abstraction"
"          0.030      0.135      0.353      0.358 c.m/sec"
"      Catchment 21      Pervious      Impervious      Total Area  "
"      Surface Area      0.738      0.082      0.820      hectare"
"      Time of concentration 24.883      2.563      18.750      minutes"
"      Time to Centroid 128.082      88.517      117.210      minutes"
"      Rainfall depth 49.792      49.792      49.792      mm"
"      Rainfall volume 367.46      40.83      408.29      c.m"
"      Rainfall losses 36.970      6.066      33.879      mm"
"      Runoff depth 12.822      43.726      15.913      mm"
"      Runoff volume 94.63      35.86      130.48      c.m"
"      Runoff coefficient 0.258      0.878      0.320      "
"      Maximum flow 0.025      0.021      0.030      c.m/sec"
" 40 HYDROGRAPH Add Runoff "
"      4 Add Runoff "
"          0.030      0.152      0.353      0.358"
" 40 HYDROGRAPH Copy to Outflow"
"      8 Copy to Outflow"
"          0.030      0.152      0.152      0.358"
" 40 HYDROGRAPH Combine 2"
"      6 Combine "
"      2 Node #"
"      To Walser Street"
"      Maximum flow 0.510      c.m/sec"
"      Hydrograph volume 2937.711      c.m"
"          0.030      0.152      0.152      0.510"
" 38 START/RE-START TOTALS 21"
"      3 Runoff Totals on EXIT"
"      Total Catchment area 22.700      hectare"
"      Total Impervious area 0.082      hectare"
"      Total % impervious 0.361"
" 19 EXIT"

```

UnconEx_10yr

```

"          MIDUSS Output ----->"
"          MIDUSS version                Version 2.25 rev. 473"
"          MIDUSS created                Sunday, February 07, 2010"
"          10 Units used:                ie METRIC"
"          Job folder:                   w:\Kitchener\411-2011\411009\Design Data\
"                                         Modelling Files\2019-02-15\Uncontrolled"
"          Output filename:              UnconEx_10yr.out"
"          Licensee name:                gmbp"
"          Company                       Hewlett-Packard Company"
"          Date & Time last used:       2/15/2019 at 1:33:01 PM"
" 31          TIME PARAMETERS"
"          5.000 Time Step"
"          180.000 Max. Storm length"
"          3600.000 Max. Hydrograph"
" 32          STORM Chicago storm"
"          1 Chicago storm"
"          2327.596 Coefficient A"
"          19.500 Constant B"
"          0.894 Exponent C"
"          0.380 Fraction R"
"          180.000 Duration"
"          1.000 Time step multiplier"
"          Maximum intensity             126.171 mm/hr"
"          Total depth                   61.359 mm"
"          6 010hyd Hydrograph extension used in this file"
" 33          CATCHMENT 30"
"          1 Triangular SCS"
"          1 Equal length"
"          1 SCS method"
"          30 Catchment 30"
"          0.000 % Impervious"
"          0.220 Total Area"
"          20.000 Flow length"
"          2.000 Overland slope"
"          0.220 Pervious Area"
"          20.000 Pervious length"
"          2.000 Pervious slope"
"          0.000 Impervious Area"
"          20.000 Impervious length"
"          2.000 Impervious slope"
"          0.250 Pervious Manning 'n'"
"          74.000 Pervious SCS Curve No."
"          0.316 Pervious Runoff coefficient"
"          0.100 Pervious Ia/S coefficient"
"          8.924 Pervious Initial abstraction"
"          0.015 Impervious Manning 'n'"
"          98.000 Impervious SCS Curve No."
"          0.000 Impervious Runoff coefficient"
"          0.100 Impervious Ia/S coefficient"
"          0.518 Impervious Initial abstraction"
"          0.015 0.000 0.000 0.000 c.m/sec"
"          Catchment 30 Pervious Impervious Total Area "
"          Surface Area 0.220 0.000 0.220 hectare"
"          Time of concentration 14.182 1.611 14.182 minutes"
"          Time to Centroid 113.894 86.563 113.893 minutes"
"          Rainfall depth 61.359 61.359 61.359 mm"
"          Rainfall volume 134.99 0.00 134.99 c.m"
"          Rainfall losses 41.992 6.044 41.992 mm"
"          Runoff depth 19.367 55.315 19.367 mm"
"          Runoff volume 42.61 0.00 42.61 c.m"
"          Runoff coefficient 0.316 0.000 0.316 "
"          Maximum flow 0.015 0.000 0.015 c.m/sec"
" 40          HYDROGRAPH Add Runoff "

```

```

UnconEx_10yr
"      4  Add Runoff "
"      0.015      0.015      0.000      0.000"
" 40  HYDROGRAPH Copy to Outflow"
"      8  Copy to Outflow"
"      0.015      0.015      0.015      0.000"
" 40  HYDROGRAPH Combine 2"
"      6  Combine "
"      2  Node #"
"      To Walser Street"
"      Maximum flow      0.015      c.m/sec"
"      Hydrograph volume      42.608      c.m"
"      0.015      0.015      0.015      0.015"
" 40  HYDROGRAPH Start - New Tributary"
"      2  Start - New Tributary"
"      0.015      0.000      0.015      0.015"
" 33  CATCHMENT 10"
"      1  Triangular SCS"
"      1  Equal length"
"      1  SCS method"
"      10  Catchment 10"
"      0.000  % Impervious"
"      7.760  Total Area"
"      150.000  Flow length"
"      2.000  Overland Slope"
"      7.760  Pervious Area"
"      150.000  Pervious length"
"      2.000  Pervious slope"
"      0.000  Impervious Area"
"      150.000  Impervious length"
"      2.000  Impervious slope"
"      0.250  Pervious Manning 'n'"
"      74.000  Pervious SCS Curve No."
"      0.316  Pervious Runoff coefficient"
"      0.100  Pervious Ia/S coefficient"
"      8.924  Pervious Initial abstraction"
"      0.015  Impervious Manning 'n'"
"      98.000  Impervious SCS Curve No."
"      0.000  Impervious Runoff coefficient"
"      0.100  Impervious Ia/S coefficient"
"      0.518  Impervious Initial abstraction"
"      0.273      0.000      0.015      0.015 c.m/sec"
"      Catchment 10      Pervious      Impervious      Total Area "
"      Surface Area      7.760      0.000      7.760      hectare"
"      Time of concentration      47.507      5.395      47.507      minutes"
"      Time to Centroid      151.963      91.698      151.963      minutes"
"      Rainfall depth      61.359      61.359      61.359      mm"
"      Rainfall volume      4761.47      0.00      4761.48      c.m"
"      Rainfall losses      41.963      5.633      41.963      mm"
"      Runoff depth      19.396      55.726      19.396      mm"
"      Runoff volume      1505.11      0.00      1505.12      c.m"
"      Runoff coefficient      0.316      0.000      0.316      "
"      Maximum flow      0.273      0.000      0.273      c.m/sec"
" 40  HYDROGRAPH Add Runoff "
"      4  Add Runoff "
"      0.273      0.273      0.015      0.015"
" 33  CATCHMENT 11"
"      1  Triangular SCS"
"      1  Equal length"
"      1  SCS method"
"      11  Catchment 11"
"      0.000  % Impervious"
"      0.130  Total Area"
"      40.000  Flow length"

```

UnconEx_10yr

"	2.000	Overland Slope"				
"	0.130	Pervious Area"				
"	40.000	Pervious length"				
"	2.000	Pervious slope"				
"	0.000	Impervious Area"				
"	40.000	Impervious length"				
"	2.000	Impervious slope"				
"	0.250	Pervious Manning 'n'"				
"	74.000	Pervious SCS Curve No."				
"	0.316	Pervious Runoff coefficient"				
"	0.100	Pervious Ia/S coefficient"				
"	8.924	Pervious Initial abstraction"				
"	0.015	Impervious Manning 'n'"				
"	98.000	Impervious SCS Curve No."				
"	0.000	Impervious Runoff coefficient"				
"	0.100	Impervious Ia/S coefficient"				
"	0.518	Impervious Initial abstraction"				
"		0.008	0.273	0.015	0.015 c.m/sec"	
"		Catchment 11	Pervious	Impervious	Total Area	"
"		Surface Area	0.130	0.000	0.130	hectare"
"		Time of concentration	21.495	2.441	21.495	minutes"
"		Time to Centroid	122.241	87.742	122.240	minutes"
"		Rainfall depth	61.359	61.359	61.359	mm"
"		Rainfall volume	79.77	0.00	79.77	c.m"
"		Rainfall losses	41.967	6.310	41.967	mm"
"		Runoff depth	19.392	55.050	19.393	mm"
"		Runoff volume	25.21	0.00	25.21	c.m"
"		Runoff coefficient	0.316	0.000	0.316	"
"		Maximum flow	0.008	0.000	0.008	c.m/sec"
" 40		HYDROGRAPH Add Runoff "				
"	4	Add Runoff "				
"		0.008	0.277	0.015	0.015"	
" 33		CATCHMENT 40"				
"	1	Triangular SCS"				
"	1	Equal length"				
"	1	SCS method"				
"	40	Catchment 40"				
"	0.000	% Impervious"				
"	7.120	Total Area"				
"	60.000	Flow length"				
"	2.000	Overland Slope"				
"	7.120	Pervious Area"				
"	60.000	Pervious length"				
"	2.000	Pervious slope"				
"	0.000	Impervious Area"				
"	60.000	Impervious length"				
"	2.000	Impervious slope"				
"	0.250	Pervious Manning 'n'"				
"	74.000	Pervious SCS Curve No."				
"	0.316	Pervious Runoff coefficient"				
"	0.100	Pervious Ia/S coefficient"				
"	8.924	Pervious Initial abstraction"				
"	0.015	Impervious Manning 'n'"				
"	98.000	Impervious SCS Curve No."				
"	0.000	Impervious Runoff coefficient"				
"	0.100	Impervious Ia/S coefficient"				
"	0.518	Impervious Initial abstraction"				
"		0.359	0.277	0.015	0.015 c.m/sec"	
"		Catchment 40	Pervious	Impervious	Total Area	"
"		Surface Area	7.120	0.000	7.120	hectare"
"		Time of concentration	27.416	3.114	27.416	minutes"
"		Time to Centroid	128.990	88.727	128.990	minutes"
"		Rainfall depth	61.359	61.359	61.359	mm"

		UnconEx_10yr			
"	Rainfall volume	4368.77	0.00	4368.78	c.m"
"	Rainfall losses	41.968	6.469	41.968	mm"
"	Runoff depth	19.392	54.890	19.392	mm"
"	Runoff volume	1380.67	0.00	1380.68	c.m"
"	Runoff coefficient	0.316	0.000	0.316	"
"	Maximum flow	0.359	0.000	0.359	c.m/sec"
40	HYDROGRAPH Add Runoff "				
"	4 Add Runoff "				
"	0.359 0.608 0.015 0.015"				
40	HYDROGRAPH Copy to Outflow"				
"	8 Copy to Outflow"				
"	0.359 0.608 0.608 0.015"				
40	HYDROGRAPH Combine 2"				
"	6 Combine "				
"	2 Node #"				
"	To Walser Street"				
"	Maximum flow	0.616		c.m/sec"	
"	Hydrograph volume	2953.615		c.m"	
"	0.359 0.608 0.608 0.616"				
40	HYDROGRAPH Start - New Tributary"				
"	2 Start - New Tributary"				
"	0.359 0.000 0.608 0.616"				
33	CATCHMENT 20"				
"	1 Triangular SCS"				
"	1 Equal length"				
"	1 SCS method"				
"	20 Catchment 20"				
"	0.000 % Impervious"				
"	6.650 Total Area"				
"	150.000 Flow length"				
"	2.000 Overland Slope"				
"	6.650 Pervious Area"				
"	150.000 Pervious length"				
"	2.000 Pervious slope"				
"	0.000 Impervious Area"				
"	150.000 Impervious length"				
"	2.000 Impervious slope"				
"	0.250 Pervious Manning 'n'"				
"	74.000 Pervious SCS Curve No."				
"	0.316 Pervious Runoff coefficient"				
"	0.100 Pervious Ia/S coefficient"				
"	8.924 Pervious Initial abstraction"				
"	0.015 Impervious Manning 'n'"				
"	98.000 Impervious SCS Curve No."				
"	0.000 Impervious Runoff coefficient"				
"	0.100 Impervious Ia/S coefficient"				
"	0.518 Impervious Initial abstraction"				
"	0.234 0.000 0.608 0.616 c.m/sec"				
"	Catchment 20 Pervious Impervious Total Area "				
"	Surface Area 6.650 0.000 6.650 hectare"				
"	Time of concentration 47.507 5.395 47.507 minutes"				
"	Time to Centroid 151.963 91.698 151.963 minutes"				
"	Rainfall depth 61.359 61.359 61.359 mm"				
"	Rainfall volume 4080.39 0.00 4080.39 c.m"				
"	Rainfall losses 41.963 5.633 41.963 mm"				
"	Runoff depth 19.396 55.726 19.396 mm"				
"	Runoff volume 1289.82 0.00 1289.82 c.m"				
"	Runoff coefficient 0.316 0.000 0.316 "				
"	Maximum flow 0.234 0.000 0.234 c.m/sec"				
40	HYDROGRAPH Add Runoff "				
"	4 Add Runoff "				
"	0.234 0.234 0.608 0.616"				
33	CATCHMENT 21"				

UnconEx_10yr

```

"      1 Triangular SCS"
"      1 Equal length"
"      1 SCS method"
"     21 Catchment 20"
"    10.000 % Impervious"
"      0.820 Total Area"
"    40.000 Flow length"
"      2.000 Overland slope"
"      0.738 Pervious Area"
"    40.000 Pervious length"
"      2.000 Pervious slope"
"      0.082 Impervious Area"
"    40.000 Impervious length"
"      2.000 Impervious slope"
"      0.250 Pervious Manning 'n'"
"    74.000 Pervious SCS Curve No."
"      0.316 Pervious Runoff coefficient"
"      0.100 Pervious Ia/S coefficient"
"      8.924 Pervious Initial abstraction"
"      0.015 Impervious Manning 'n'"
"    98.000 Impervious SCS Curve No."
"      0.897 Impervious Runoff coefficient"
"      0.100 Impervious Ia/S coefficient"
"      0.518 Impervious Initial abstraction"
"          0.049      0.234      0.608      0.616 c.m/sec"
"      Catchment 21      Pervious      Impervious      Total Area  "
"      Surface Area      0.738      0.082      0.820      hectare"
"      Time of concentration  21.495      2.441      16.926      minutes"
"      Time to Centroid      122.241      87.742      113.968      minutes"
"      Rainfall depth      61.359      61.359      61.359      mm"
"      Rainfall volume      452.83      50.31      503.15      c.m"
"      Rainfall losses      41.967      6.310      38.401      mm"
"      Runoff depth      19.392      55.050      22.958      mm"
"      Runoff volume      143.12      45.14      188.26      c.m"
"      Runoff coefficient      0.316      0.897      0.374      "
"      Maximum flow      0.043      0.024      0.049      c.m/sec"
" 40      HYDROGRAPH Add Runoff "
"      4      Add Runoff "
"          0.049      0.263      0.608      0.616"
" 40      HYDROGRAPH Copy to Outflow"
"      8      Copy to Outflow"
"          0.049      0.263      0.263      0.616"
" 40      HYDROGRAPH Combine 2"
"      6      Combine "
"      2      Node #"
"          To Walser Street"
"      Maximum flow          0.878      c.m/sec"
"      Hydrograph volume      4431.696      c.m"
"          0.049      0.263      0.263      0.878"
" 38      START/RE-START TOTALS 21"
"      3      Runoff Totals on EXIT"
"          Total Catchment area          22.700      hectare"
"          Total Impervious area          0.082      hectare"
"          Total % impervious          0.361"
" 19      EXIT"

```



```

UnconEx_25yr
"
" MIDUSS Output ----->
" MIDUSS version Version 2.25 rev. 473"
" MIDUSS created Sunday, February 07, 2010"
" 10 Units used: ie METRIC"
" Job folder: w:\Kitchener\411-2011\411009\Design Data\
" Modelling Files\2019-02-15\Uncontrolled"
" Output filename: UnconEx_25yr.out"
" Licensee name: gmbp"
" Company Hewlett-Packard Company"
" Date & Time last used: 2/15/2019 at 1:33:50 PM"
" 31 TIME PARAMETERS"
" 5.000 Time Step"
" 180.000 Max. Storm length"
" 3600.000 Max. Hydrograph"
" 32 STORM Chicago storm"
" 1 Chicago storm"
" 3701.648 Coefficient A"
" 25.500 Constant B"
" 0.937 Exponent C"
" 0.380 Fraction R"
" 180.000 Duration"
" 1.000 Time step multiplier"
" Maximum intensity 143.371 mm/hr"
" Total depth 75.581 mm"
" 6 025hyd Hydrograph extension used in this file"
" 33 CATCHMENT 30"
" 1 Triangular SCS"
" 1 Equal length"
" 1 SCS method"
" 30 Catchment 30"
" 0.000 % Impervious"
" 0.220 Total Area"
" 20.000 Flow length"
" 2.000 Overland slope"
" 0.220 Pervious Area"
" 20.000 Pervious length"
" 2.000 Pervious slope"
" 0.000 Impervious Area"
" 20.000 Impervious length"
" 2.000 Impervious slope"
" 0.250 Pervious Manning 'n'"
" 74.000 Pervious SCS Curve No."
" 0.376 Pervious Runoff coefficient"
" 0.100 Pervious Ia/S coefficient"
" 8.924 Pervious Initial abstraction"
" 0.015 Impervious Manning 'n'"
" 98.000 Impervious SCS Curve No."
" 0.000 Impervious Runoff coefficient"
" 0.100 Impervious Ia/S coefficient"
" 0.518 Impervious Initial abstraction"
" 0.024 0.000 0.000 0.000 c.m/sec"
" Catchment 30 Pervious Impervious Total Area "
" Surface Area 0.220 0.000 0.220 hectare"
" Time of concentration 12.370 1.523 12.370 minutes"
" Time to Centroid 110.314 85.984 110.314 minutes"
" Rainfall depth 75.581 75.581 mm"
" Rainfall volume 166.28 0.00 166.28 c.m"
" Rainfall losses 47.190 6.330 47.190 mm"
" Runoff depth 28.391 69.250 28.391 mm"
" Runoff volume 62.46 0.00 62.46 c.m"
" Runoff coefficient 0.376 0.000 0.376 "
" Maximum flow 0.024 0.000 0.024 c.m/sec"
" 40 HYDROGRAPH Add Runoff "

```

```

UnconEx_25yr
"      4  Add Runoff "
"      0.024  0.024  0.000  0.000"
" 40  HYDROGRAPH Copy to Outflow"
"      8  Copy to Outflow"
"      0.024  0.024  0.024  0.000"
" 40  HYDROGRAPH Combine 2"
"      6  Combine "
"      2  Node #"
"      To Walser Street"
"      Maximum flow 0.024 c.m/sec"
"      Hydrograph volume 62.461 c.m"
"      0.024  0.024  0.024  0.024"
" 40  HYDROGRAPH Start - New Tributary"
"      2  Start - New Tributary"
"      0.024  0.000  0.024  0.024"
" 33  CATCHMENT 10"
"      1  Triangular SCS"
"      1  Equal length"
"      1  SCS method"
"      10  Catchment 10"
"      0.000  % Impervious"
"      7.760  Total Area"
"      150.000  Flow length"
"      2.000  Overland Slope"
"      7.760  Pervious Area"
"      150.000  Pervious length"
"      2.000  Pervious slope"
"      0.000  Impervious Area"
"      150.000  Impervious length"
"      2.000  Impervious slope"
"      0.250  Pervious Manning 'n'"
"      74.000  Pervious SCS Curve No."
"      0.377  Pervious Runoff coefficient"
"      0.100  Pervious Ia/S coefficient"
"      8.924  Pervious Initial abstraction"
"      0.015  Impervious Manning 'n'"
"      98.000  Impervious SCS Curve No."
"      0.000  Impervious Runoff coefficient"
"      0.100  Impervious Ia/S coefficient"
"      0.518  Impervious Initial abstraction"
"      0.454  0.000  0.024  0.024 c.m/sec"
"      Catchment 10 Pervious Impervious Total Area "
"      Surface Area 7.760 0.000 7.760 hectare"
"      Time of concentration 41.437 5.102 41.437 minutes"
"      Time to Centroid 143.191 90.751 143.190 minutes"
"      Rainfall depth 75.581 75.581 75.581 mm"
"      Rainfall volume 5865.07 0.01 5865.07 c.m"
"      Rainfall losses 47.093 5.908 47.093 mm"
"      Runoff depth 28.488 69.673 28.488 mm"
"      Runoff volume 2210.64 0.01 2210.65 c.m"
"      Runoff coefficient 0.377 0.000 0.377 "
"      Maximum flow 0.454 0.000 0.454 c.m/sec"
" 40  HYDROGRAPH Add Runoff "
"      4  Add Runoff "
"      0.454  0.454  0.024  0.024"
" 33  CATCHMENT 11"
"      1  Triangular SCS"
"      1  Equal length"
"      1  SCS method"
"      11  Catchment 11"
"      0.000  % Impervious"
"      0.130  Total Area"
"      40.000  Flow length"

```

UnconEx_25yr

```

"      2.000  Overland Slope"
"      0.130  Pervious Area"
"     40.000  Pervious length"
"      2.000  Pervious slope"
"      0.000  Impervious Area"
"     40.000  Impervious length"
"      2.000  Impervious slope"
"      0.250  Pervious Manning 'n'"
"     74.000  Pervious SCS Curve No."
"      0.376  Pervious Runoff coefficient"
"      0.100  Pervious Ia/S coefficient"
"      8.924  Pervious Initial abstraction"
"      0.015  Impervious Manning 'n'"
"     98.000  Impervious SCS Curve No."
"      0.000  Impervious Runoff coefficient"
"      0.100  Impervious Ia/S coefficient"
"      0.518  Impervious Initial abstraction"
"          0.012      0.454      0.024      0.024 c.m/sec"
"      Catchment 11      Pervious      Impervious      Total Area      "
"      Surface Area      0.130      0.000      0.130      hectare"
"      Time of concentration      18.749      2.308      18.749      minutes"
"      Time to Centroid      117.510      87.059      117.510      minutes"
"      Rainfall depth      75.581      75.581      75.581      mm"
"      Rainfall volume      98.25      0.00      98.26      c.m"
"      Rainfall losses      47.127      6.593      47.127      mm"
"      Runoff depth      28.453      68.988      28.453      mm"
"      Runoff volume      36.99      0.00      36.99      c.m"
"      Runoff coefficient      0.376      0.000      0.376      "
"      Maximum flow      0.012      0.000      0.012      c.m/sec"
" 40      HYDROGRAPH Add Runoff "
"      4      Add Runoff "
"          0.012      0.461      0.024      0.024"
" 33      CATCHMENT 40"
"      1      Triangular SCS"
"      1      Equal length"
"      1      SCS method"
"      40      Catchment 40"
"      0.000  % Impervious"
"      7.120  Total Area"
"     60.000  Flow length"
"      2.000  Overland Slope"
"      7.120  Pervious Area"
"     60.000  Pervious length"
"      2.000  Pervious slope"
"      0.000  Impervious Area"
"     60.000  Impervious length"
"      2.000  Impervious slope"
"      0.250  Pervious Manning 'n'"
"     74.000  Pervious SCS Curve No."
"      0.377  Pervious Runoff coefficient"
"      0.100  Pervious Ia/S coefficient"
"      8.924  Pervious Initial abstraction"
"      0.015  Impervious Manning 'n'"
"     98.000  Impervious SCS Curve No."
"      0.000  Impervious Runoff coefficient"
"      0.100  Impervious Ia/S coefficient"
"      0.518  Impervious Initial abstraction"
"          0.584      0.461      0.024      0.024 c.m/sec"
"      Catchment 40      Pervious      Impervious      Total Area      "
"      Surface Area      7.120      0.000      7.120      hectare"
"      Time of concentration      23.913      2.944      23.913      minutes"
"      Time to Centroid      123.357      87.974      123.357      minutes"
"      Rainfall depth      75.581      75.581      75.581      mm"

```

		UnconEx_25yr			
"	Rainfall volume	5381.35	0.01	5381.36	c.m"
"	Rainfall losses	47.108	6.942	47.107	mm"
"	Runoff depth	28.473	68.639	28.473	mm"
"	Runoff volume	2027.30	0.00	2027.30	c.m"
"	Runoff coefficient	0.377	0.000	0.377	"
"	Maximum flow	0.584	0.000	0.584	c.m/sec"
40	HYDROGRAPH Add Runoff "				
"	4 Add Runoff "				
"	0.584 1.001 0.024 0.024"				
40	HYDROGRAPH Copy to Outflow"				
"	8 Copy to Outflow"				
"	0.584 1.001 1.001 0.024"				
40	HYDROGRAPH Combine 2"				
"	6 Combine "				
"	2 Node #"				
"	To Walser Street"				
"	Maximum flow 1.015 c.m/sec"				
"	Hydrograph volume 4337.402 c.m"				
"	0.584 1.001 1.001 1.015"				
40	HYDROGRAPH Start - New Tributary"				
"	2 Start - New Tributary"				
"	0.584 0.000 1.001 1.015"				
33	CATCHMENT 20"				
"	1 Triangular SCS"				
"	1 Equal length"				
"	1 SCS method"				
"	20 Catchment 20"				
"	0.000 % Impervious"				
"	6.650 Total Area"				
"	150.000 Flow length"				
"	2.000 Overland Slope"				
"	6.650 Pervious Area"				
"	150.000 Pervious length"				
"	2.000 Pervious slope"				
"	0.000 Impervious Area"				
"	150.000 Impervious length"				
"	2.000 Impervious slope"				
"	0.250 Pervious Manning 'n'"				
"	74.000 Pervious SCS Curve No."				
"	0.377 Pervious Runoff coefficient"				
"	0.100 Pervious Ia/S coefficient"				
"	8.924 Pervious Initial abstraction"				
"	0.015 Impervious Manning 'n'"				
"	98.000 Impervious SCS Curve No."				
"	0.000 Impervious Runoff coefficient"				
"	0.100 Impervious Ia/S coefficient"				
"	0.518 Impervious Initial abstraction"				
"	0.389 0.000 1.001 1.015 c.m/sec"				
"	Catchment 20 Pervious Impervious Total Area "				
"	Surface Area 6.650 0.000 6.650 hectare"				
"	Time of concentration 41.437 5.102 41.437 minutes"				
"	Time to Centroid 143.191 90.751 143.190 minutes"				
"	Rainfall depth 75.581 75.581 75.581 mm"				
"	Rainfall volume 5026.12 0.01 5026.13 c.m"				
"	Rainfall losses 47.093 5.908 47.093 mm"				
"	Runoff depth 28.488 69.673 28.488 mm"				
"	Runoff volume 1894.43 0.00 1894.44 c.m"				
"	Runoff coefficient 0.377 0.000 0.377 "				
"	Maximum flow 0.389 0.000 0.389 c.m/sec"				
40	HYDROGRAPH Add Runoff "				
"	4 Add Runoff "				
"	0.389 0.389 1.001 1.015"				
33	CATCHMENT 21"				

UnconEx_25yr

```

"      1 Triangular SCS"
"      1 Equal length"
"      1 SCS method"
"     21 Catchment 20"
"    10.000 % Impervious"
"      0.820 Total Area"
"    40.000 Flow length"
"      2.000 Overland slope"
"      0.738 Pervious Area"
"    40.000 Pervious length"
"      2.000 Pervious slope"
"      0.082 Impervious Area"
"    40.000 Impervious length"
"      2.000 Impervious slope"
"      0.250 Pervious Manning 'n'"
"    74.000 Pervious SCS Curve No."
"      0.376 Pervious Runoff coefficient"
"      0.100 Pervious Ia/S coefficient"
"      8.924 Pervious Initial abstraction"
"      0.015 Impervious Manning 'n'"
"    98.000 Impervious SCS Curve No."
"      0.913 Impervious Runoff coefficient"
"      0.100 Impervious Ia/S coefficient"
"      0.518 Impervious Initial abstraction"
"          0.078      0.389      1.001      1.015 c.m/sec"
"      Catchment 21      Pervious      Impervious      Total Area "
"      Surface Area      0.738      0.082      0.820      hectare"
"      Time of concentration      18.749      2.308      15.260      minutes"
"      Time to Centroid      117.510      87.059      111.048      minutes"
"      Rainfall depth      75.581      75.581      75.581      mm"
"      Rainfall volume      557.79      61.98      619.76      c.m"
"      Rainfall losses      47.127      6.593      43.074      mm"
"      Runoff depth      28.453      68.988      32.507      mm"
"      Runoff volume      209.99      56.57      266.56      c.m"
"      Runoff coefficient      0.376      0.913      0.430      "
"      Maximum flow      0.068      0.028      0.078      c.m/sec"
" 40      HYDROGRAPH Add Runoff "
"      4      Add Runoff "
"          0.078      0.435      1.001      1.015"
" 40      HYDROGRAPH Copy to Outflow"
"      8      Copy to Outflow"
"          0.078      0.435      0.435      1.015"
" 40      HYDROGRAPH Combine 2"
"      6      Combine "
"      2      Node #"
"          To Walser Street"
"      Maximum flow      1.447      c.m/sec"
"      Hydrograph volume      6498.396      c.m"
"          0.078      0.435      0.435      1.447"
" 38      START/RE-START TOTALS 21"
"      3      Runoff Totals on EXIT"
"      Total Catchment area      22.700      hectare"
"      Total Impervious area      0.082      hectare"
"      Total % impervious      0.361"
" 19      EXIT"

```

UnconEx_50yr

```

"          MIDUSS Output ----->"
"          MIDUSS version                Version 2.25 rev. 473"
"          MIDUSS created                 Sunday, February 07, 2010"
"          10 Units used:                  ie METRIC"
"          Job folder:                    w:\Kitchener\411-2011\411009\Design Data\
"                                         Modelling Files\2019-02-15\Uncontrolled"
"          Output filename:               UnconEx_50yr.out"
"          Licensee name:                 gmbp"
"          Company                        Hewlett-Packard Company"
"          Date & Time last used:        2/15/2019 at 1:35:10 PM"
" 31          TIME PARAMETERS"
"          5.000 Time Step"
"          180.000 Max. Storm length"
"          3600.000 Max. Hydrograph"
" 32          STORM Chicago storm"
"          1 Chicago storm"
"          5089.418 Coefficient A"
"          30.000 Constant B"
"          0.967 Exponent C"
"          0.380 Fraction R"
"          180.000 Duration"
"          1.000 Time step multiplier"
"          Maximum intensity              156.350 mm/hr"
"          Total depth                    86.737 mm"
"          6 050hyd Hydrograph extension used in this file"
" 33          CATCHMENT 30"
"          1 Triangular SCS"
"          1 Equal length"
"          1 SCS method"
"          30 Catchment 30"
"          0.000 % Impervious"
"          0.220 Total Area"
"          20.000 Flow length"
"          2.000 Overland slope"
"          0.220 Pervious Area"
"          20.000 Pervious length"
"          2.000 Pervious slope"
"          0.000 Impervious Area"
"          20.000 Impervious length"
"          2.000 Impervious slope"
"          0.250 Pervious Manning 'n'"
"          74.000 Pervious SCS Curve No."
"          0.417 Pervious Runoff coefficient"
"          0.100 Pervious Ia/S coefficient"
"          8.924 Pervious Initial abstraction"
"          0.015 Impervious Manning 'n'"
"          98.000 Impervious SCS Curve No."
"          0.000 Impervious Runoff coefficient"
"          0.100 Impervious Ia/S coefficient"
"          0.518 Impervious Initial abstraction"
"          0.032 0.000 0.000 0.000 c.m/sec"
"          Catchment 30 Pervious Impervious Total Area "
"          Surface Area 0.220 0.000 0.220 hectare"
"          Time of concentration 11.375 1.467 11.375 minutes"
"          Time to Centroid 108.305 85.675 108.305 minutes"
"          Rainfall depth 86.737 86.737 86.737 mm"
"          Rainfall volume 190.82 0.00 190.82 c.m"
"          Rainfall losses 50.570 6.561 50.570 mm"
"          Runoff depth 36.167 80.176 36.167 mm"
"          Runoff volume 79.57 0.00 79.57 c.m"
"          Runoff coefficient 0.417 0.000 0.417 "
"          Maximum flow 0.032 0.000 0.032 c.m/sec"
" 40          HYDROGRAPH Add Runoff "

```

```

UnconEx_50yr
"      4  Add Runoff "
"      0.032  0.032  0.000  0.000"
" 40  HYDROGRAPH Copy to Outflow"
"      8  Copy to Outflow"
"      0.032  0.032  0.032  0.000"
" 40  HYDROGRAPH Combine 2"
"      6  Combine "
"      2  Node #"
"      To Walser Street"
"      Maximum flow 0.032 c.m/sec"
"      Hydrograph volume 79.567 c.m"
"      0.032  0.032  0.032  0.032"
" 40  HYDROGRAPH Start - New Tributary"
"      2  Start - New Tributary"
"      0.032  0.000  0.032  0.032"
" 33  CATCHMENT 10"
"      1  Triangular SCS"
"      1  Equal length"
"      1  SCS method"
"      10  Catchment 10"
"      0.000  % Impervious"
"      7.760  Total Area"
"      150.000  Flow length"
"      2.000  Overland Slope"
"      7.760  Pervious Area"
"      150.000  Pervious length"
"      2.000  Pervious slope"
"      0.000  Impervious Area"
"      150.000  Impervious length"
"      2.000  Impervious slope"
"      0.250  Pervious Manning 'n'"
"      74.000  Pervious SCS Curve No."
"      0.418  Pervious Runoff coefficient"
"      0.100  Pervious Ia/S coefficient"
"      8.924  Pervious Initial abstraction"
"      0.015  Impervious Manning 'n'"
"      98.000  Impervious SCS Curve No."
"      0.000  Impervious Runoff coefficient"
"      0.100  Impervious Ia/S coefficient"
"      0.518  Impervious Initial abstraction"
"      0.618  0.000  0.032  0.032 c.m/sec"
"      Catchment 10 Pervious Impervious Total Area "
"      Surface Area 7.760 0.000 7.760 hectare"
"      Time of concentration 38.106 4.916 38.106 minutes"
"      Time to Centroid 138.366 90.175 138.366 minutes"
"      Rainfall depth 86.737 86.737 86.737 mm"
"      Rainfall volume 6730.77 0.01 6730.77 c.m"
"      Rainfall losses 50.510 5.941 50.510 mm"
"      Runoff depth 36.227 80.796 36.227 mm"
"      Runoff volume 2811.21 0.01 2811.22 c.m"
"      Runoff coefficient 0.418 0.000 0.418 "
"      Maximum flow 0.618 0.000 0.618 c.m/sec"
" 40  HYDROGRAPH Add Runoff "
"      4  Add Runoff "
"      0.618  0.618  0.032  0.032"
" 33  CATCHMENT 11"
"      1  Triangular SCS"
"      1  Equal length"
"      1  SCS method"
"      11  Catchment 11"
"      0.000  % Impervious"
"      0.130  Total Area"
"      40.000  Flow length"

```

UnconEx_50yr

```

"      2.000  Overland Slope"
"      0.130  Pervious Area"
"     40.000  Pervious length"
"      2.000  Pervious slope"
"      0.000  Impervious Area"
"     40.000  Impervious length"
"      2.000  Impervious slope"
"      0.250  Pervious Manning 'n'"
"     74.000  Pervious SCS Curve No."
"      0.417  Pervious Runoff coefficient"
"      0.100  Pervious Ia/S coefficient"
"      8.924  Pervious Initial abstraction"
"      0.015  Impervious Manning 'n'"
"     98.000  Impervious SCS Curve No."
"      0.000  Impervious Runoff coefficient"
"      0.100  Impervious Ia/S coefficient"
"      0.518  Impervious Initial abstraction"
"          0.016    0.618    0.032    0.032 c.m/sec"
"      Catchment 11      Pervious      Impervious      Total Area  "
"      Surface Area      0.130      0.000      0.130      hectare"
"      Time of concentration  17.241    2.224    17.241    minutes"
"      Time to Centroid    114.897  86.667   114.896   minutes"
"      Rainfall depth      86.737   86.737   86.737    mm"
"      Rainfall volume     112.76   0.00     112.76    c.m"
"      Rainfall losses     50.540   6.773   50.540    mm"
"      Runoff depth        36.197   79.963   36.197    mm"
"      Runoff volume       47.06    0.00     47.06     c.m"
"      Runoff coefficient   0.417    0.000    0.417     "
"      Maximum flow        0.016    0.000    0.016     c.m/sec"
" 40      HYDROGRAPH Add Runoff "
"          4      Add Runoff "
"          0.016    0.628    0.032    0.032"
" 33      CATCHMENT 40"
"          1      Triangular SCS"
"          1      Equal length"
"          1      SCS method"
"          40     Catchment 40"
"          0.000  % Impervious"
"          7.120  Total Area"
"         60.000  Flow length"
"          2.000  Overland Slope"
"          7.120  Pervious Area"
"         60.000  Pervious length"
"          2.000  Pervious slope"
"          0.000  Impervious Area"
"         60.000  Impervious length"
"          2.000  Impervious slope"
"          0.250  Pervious Manning 'n'"
"         74.000  Pervious SCS Curve No."
"          0.417  Pervious Runoff coefficient"
"          0.100  Pervious Ia/S coefficient"
"          8.924  Pervious Initial abstraction"
"          0.015  Impervious Manning 'n'"
"         98.000  Impervious SCS Curve No."
"          0.000  Impervious Runoff coefficient"
"          0.100  Impervious Ia/S coefficient"
"          0.518  Impervious Initial abstraction"
"          0.789    0.628    0.032    0.032 c.m/sec"
"      Catchment 40      Pervious      Impervious      Total Area  "
"      Surface Area      7.120      0.000      7.120      hectare"
"      Time of concentration  21.990    2.837    21.990    minutes"
"      Time to Centroid    120.254  87.552   120.254   minutes"
"      Rainfall depth      86.737   86.737   86.737    mm"

```

		UnconEx_50yr			
"	Rainfall volume	6175.65	0.01	6175.66	c.m"
"	Rainfall losses	50.538	7.307	50.538	mm"
"	Runoff depth	36.199	79.429	36.199	mm"
"	Runoff volume	2577.38	0.01	2577.39	c.m"
"	Runoff coefficient	0.417	0.000	0.417	"
"	Maximum flow	0.789	0.000	0.789	c.m/sec"
40	HYDROGRAPH Add Runoff "				
"	4 Add Runoff "				
"	0.789 1.341	0.032	0.032"		
40	HYDROGRAPH Copy to Outflow"				
"	8 Copy to Outflow"				
"	0.789 1.341	1.341	0.032"		
40	HYDROGRAPH Combine 2"				
"	6 Combine "				
"	2 Node #"				
"	To Walser Street"				
"	Maximum flow	1.359	c.m/sec"		
"	Hydrograph volume	5515.226	c.m"		
"	0.789 1.341	1.341	1.359"		
40	HYDROGRAPH Start - New Tributary"				
"	2 Start - New Tributary"				
"	0.789 0.000	1.341	1.359"		
33	CATCHMENT 20"				
"	1 Triangular SCS"				
"	1 Equal length"				
"	1 SCS method"				
"	20 Catchment 20"				
"	0.000 % Impervious"				
"	6.650 Total Area"				
"	150.000 Flow length"				
"	2.000 Overland Slope"				
"	6.650 Pervious Area"				
"	150.000 Pervious length"				
"	2.000 Pervious slope"				
"	0.000 Impervious Area"				
"	150.000 Impervious length"				
"	2.000 Impervious slope"				
"	0.250 Pervious Manning 'n'"				
"	74.000 Pervious SCS Curve No."				
"	0.418 Pervious Runoff coefficient"				
"	0.100 Pervious Ia/S coefficient"				
"	8.924 Pervious Initial abstraction"				
"	0.015 Impervious Manning 'n'"				
"	98.000 Impervious SCS Curve No."				
"	0.000 Impervious Runoff coefficient"				
"	0.100 Impervious Ia/S coefficient"				
"	0.518 Impervious Initial abstraction"				
"	0.530 0.000 1.341	1.359	c.m/sec"		
"	Catchment 20 Pervious	Impervious	Total Area "		
"	Surface Area	6.650	0.000	6.650	hectare"
"	Time of concentration	38.106	4.916	38.106	minutes"
"	Time to Centroid	138.366	90.175	138.366	minutes"
"	Rainfall depth	86.737	86.737	86.737	mm"
"	Rainfall volume	5767.99	0.01	5768.00	c.m"
"	Rainfall losses	50.510	5.941	50.510	mm"
"	Runoff depth	36.227	80.796	36.227	mm"
"	Runoff volume	2409.09	0.01	2409.10	c.m"
"	Runoff coefficient	0.418	0.000	0.418	"
"	Maximum flow	0.530	0.000	0.530	c.m/sec"
40	HYDROGRAPH Add Runoff "				
"	4 Add Runoff "				
"	0.530 0.530	1.341	1.359"		
33	CATCHMENT 21"				

UnconEx_50yr

```

"      1 Triangular SCS"
"      1 Equal length"
"      1 SCS method"
"     21 Catchment 20"
"    10.000 % Impervious"
"      0.820 Total Area"
"    40.000 Flow length"
"      2.000 Overland slope"
"      0.738 Pervious Area"
"    40.000 Pervious length"
"      2.000 Pervious slope"
"      0.082 Impervious Area"
"    40.000 Impervious length"
"      2.000 Impervious slope"
"      0.250 Pervious Manning 'n'"
"    74.000 Pervious SCS Curve No."
"      0.417 Pervious Runoff coefficient"
"      0.100 Pervious Ia/S coefficient"
"      8.924 Pervious Initial abstraction"
"      0.015 Impervious Manning 'n'"
"    98.000 Impervious SCS Curve No."
"      0.922 Impervious Runoff coefficient"
"      0.100 Impervious Ia/S coefficient"
"      0.518 Impervious Initial abstraction"
"          0.103      0.530      1.341      1.359 c.m/sec"
"      Catchment 21      Pervious      Impervious      Total Area "
"      Surface Area      0.738      0.082      0.820      hectare"
"      Time of concentration      17.241      2.224      14.282      minutes"
"      Time to Centroid      114.897      86.667      109.333      minutes"
"      Rainfall depth      86.737      86.737      86.737      mm"
"      Rainfall volume      640.12      71.12      711.24      c.m"
"      Rainfall losses      50.540      6.773      46.163      mm"
"      Runoff depth      36.197      79.963      40.574      mm"
"      Runoff volume      267.13      65.57      332.70      c.m"
"      Runoff coefficient      0.417      0.922      0.468      "
"      Maximum flow      0.091      0.031      0.103      c.m/sec"
" 40      HYDROGRAPH Add Runoff "
"      4      Add Runoff "
"          0.103      0.592      1.341      1.359"
" 40      HYDROGRAPH Copy to Outflow"
"      8      Copy to Outflow"
"          0.103      0.592      0.592      1.359"
" 40      HYDROGRAPH Combine 2"
"      6      Combine "
"      2      Node #"
"          To Walser Street"
"      Maximum flow          1.948      c.m/sec"
"      Hydrograph volume      8257.032      c.m"
"          0.103      0.592      0.592      1.948"
" 38      START/RE-START TOTALS 21"
"      3      Runoff Totals on EXIT"
"      Total Catchment area          22.700      hectare"
"      Total Impervious area          0.082      hectare"
"      Total % impervious          0.361"
" 19      EXIT"

```

UnconEx_100yr

```

"          MIDUSS Output ----->"
"          MIDUSS version                Version 2.25 rev. 473"
"          MIDUSS created                Sunday, February 07, 2010"
"          10 Units used:                ie METRIC"
"          Job folder:                   w:\Kitchener\411-2011\411009\Design Data\
"                                         Modelling Files\2019-02-15\Uncontrolled"
"          Output filename:              UnconEx_100yr.out"
"          Licensee name:                gmbp"
"          Company                       Hewlett-Packard Company"
"          Date & Time last used:       2/15/2019 at 1:35:55 PM"
" 31          TIME PARAMETERS"
"          5.000 Time Step"
"          180.000 Max. Storm length"
"          3600.000 Max. Hydrograph"
" 32          STORM Chicago storm"
"          1 Chicago storm"
"          6933.019 Coefficient A"
"          34.699 Constant B"
"          0.998 Exponent C"
"          0.380 Fraction R"
"          180.000 Duration"
"          1.000 Time step multiplier"
"          Maximum intensity             168.777 mm/hr"
"          Total depth                   97.921 mm"
"          6 100hyd Hydrograph extension used in this file"
" 33          CATCHMENT 30"
"          1 Triangular SCS"
"          1 Equal length"
"          1 SCS method"
"          30 Catchment 30"
"          0.000 % Impervious"
"          0.220 Total Area"
"          20.000 Flow length"
"          2.000 Overland slope"
"          0.220 Pervious Area"
"          20.000 Pervious length"
"          2.000 Pervious slope"
"          0.000 Impervious Area"
"          20.000 Impervious length"
"          2.000 Impervious slope"
"          0.250 Pervious Manning 'n'"
"          74.000 Pervious SCS Curve No."
"          0.452 Pervious Runoff coefficient"
"          0.100 Pervious Ia/S coefficient"
"          8.924 Pervious Initial abstraction"
"          0.015 Impervious Manning 'n'"
"          98.000 Impervious SCS Curve No."
"          0.000 Impervious Runoff coefficient"
"          0.100 Impervious Ia/S coefficient"
"          0.518 Impervious Initial abstraction"
"          0.039 0.000 0.000 0.000 c.m/sec"
"          Catchment 30 Pervious Impervious Total Area "
"          Surface Area 0.220 0.000 0.220 hectare"
"          Time of concentration 10.606 1.421 10.606 minutes"
"          Time to Centroid 106.728 85.423 106.728 minutes"
"          Rainfall depth 97.921 97.921 97.921 mm"
"          Rainfall volume 215.43 0.00 215.43 c.m"
"          Rainfall losses 53.628 6.787 53.628 mm"
"          Runoff depth 44.293 91.134 44.294 mm"
"          Runoff volume 97.45 0.00 97.45 c.m"
"          Runoff coefficient 0.452 0.000 0.452 "
"          Maximum flow 0.039 0.000 0.039 c.m/sec"
" 40          HYDROGRAPH Add Runoff "

```

```

UnconEx_100yr
"      4  Add Runoff "
"      0.039  0.039  0.000  0.000"
" 40  HYDROGRAPH Copy to Outflow"
"      8  Copy to Outflow"
"      0.039  0.039  0.039  0.000"
" 40  HYDROGRAPH Combine 2"
"      6  Combine "
"      2  Node #"
"      To Walser Street"
"      Maximum flow 0.039 c.m/sec"
"      Hydrograph volume 97.446 c.m"
"      0.039  0.039  0.039  0.039"
" 40  HYDROGRAPH Start - New Tributary"
"      2  Start - New Tributary"
"      0.039  0.000  0.039  0.039"
" 33  CATCHMENT 10"
"      1  Triangular SCS"
"      1  Equal length"
"      1  SCS method"
"      10  Catchment 10"
"      0.000  % Impervious"
"      7.760  Total Area"
"      150.000  Flow length"
"      2.000  Overland Slope"
"      7.760  Pervious Area"
"      150.000  Pervious length"
"      2.000  Pervious slope"
"      0.000  Impervious Area"
"      150.000  Impervious length"
"      2.000  Impervious slope"
"      0.250  Pervious Manning 'n'"
"      74.000  Pervious SCS Curve No."
"      0.454  Pervious Runoff coefficient"
"      0.100  Pervious Ia/S coefficient"
"      8.924  Pervious Initial abstraction"
"      0.015  Impervious Manning 'n'"
"      98.000  Impervious SCS Curve No."
"      0.000  Impervious Runoff coefficient"
"      0.100  Impervious Ia/S coefficient"
"      0.518  Impervious Initial abstraction"
"      0.801  0.000  0.039  0.039 c.m/sec"
"      Catchment 10 Pervious Impervious Total Area "
"      Surface Area 7.760 0.000 7.760 hectare"
"      Time of concentration 35.531 4.759 35.530 minutes"
"      Time to Centroid 134.554 89.737 134.554 minutes"
"      Rainfall depth 97.921 97.921 97.921 mm"
"      Rainfall volume 7598.69 0.01 7598.69 c.m"
"      Rainfall losses 53.501 6.084 53.501 mm"
"      Runoff depth 44.420 91.837 44.420 mm"
"      Runoff volume 3447.00 0.01 3447.01 c.m"
"      Runoff coefficient 0.454 0.000 0.454 "
"      Maximum flow 0.801 0.000 0.801 c.m/sec"
" 40  HYDROGRAPH Add Runoff "
"      4  Add Runoff "
"      0.801  0.801  0.039  0.039"
" 33  CATCHMENT 11"
"      1  Triangular SCS"
"      1  Equal length"
"      1  SCS method"
"      11  Catchment 11"
"      0.000  % Impervious"
"      0.130  Total Area"
"      40.000  Flow length"

```

UnconEx_100yr

```

"      2.000  Overland Slope"
"      0.130  Pervious Area"
"     40.000  Pervious length"
"      2.000  Pervious slope"
"      0.000  Impervious Area"
"     40.000  Impervious length"
"      2.000  Impervious slope"
"      0.250  Pervious Manning 'n'"
"     74.000  Pervious SCS Curve No."
"      0.453  Pervious Runoff coefficient"
"      0.100  Pervious Ia/S coefficient"
"      8.924  Pervious Initial abstraction"
"      0.015  Impervious Manning 'n'"
"     98.000  Impervious SCS Curve No."
"      0.000  Impervious Runoff coefficient"
"      0.100  Impervious Ia/S coefficient"
"      0.518  Impervious Initial abstraction"
"          0.020    0.801    0.039    0.039 c.m/sec"
"      Catchment 11      Pervious      Impervious      Total Area  "
"      Surface Area      0.130      0.000      0.130      hectare"
"      Time of concentration  16.076    2.153    16.076    minutes"
"      Time to Centroid    112.853  86.345   112.853   minutes"
"      Rainfall depth      97.921   97.921   97.921    mm"
"      Rainfall volume     127.30   0.00     127.30    c.m"
"      Rainfall losses     53.605   6.948    53.605    mm"
"      Runoff depth        44.316   90.973   44.316    mm"
"      Runoff volume       57.61    0.00     57.61     c.m"
"      Runoff coefficient   0.453    0.000    0.453     "
"      Maximum flow       0.020    0.000    0.020     c.m/sec"
" 40  HYDROGRAPH Add Runoff "
"      4  Add Runoff "
"          0.020    0.813    0.039    0.039"
" 33  CATCHMENT 40"
"      1  Triangular SCS"
"      1  Equal length"
"      1  SCS method"
"      40  Catchment 40"
"      0.000  % Impervious"
"      7.120  Total Area"
"     60.000  Flow length"
"      2.000  Overland Slope"
"      7.120  Pervious Area"
"     60.000  Pervious length"
"      2.000  Pervious slope"
"      0.000  Impervious Area"
"     60.000  Impervious length"
"      2.000  Impervious slope"
"      0.250  Pervious Manning 'n'"
"     74.000  Pervious SCS Curve No."
"      0.453  Pervious Runoff coefficient"
"      0.100  Pervious Ia/S coefficient"
"      8.924  Pervious Initial abstraction"
"      0.015  Impervious Manning 'n'"
"     98.000  Impervious SCS Curve No."
"      0.000  Impervious Runoff coefficient"
"      0.100  Impervious Ia/S coefficient"
"      0.518  Impervious Initial abstraction"
"          0.985    0.813    0.039    0.039 c.m/sec"
"      Catchment 40      Pervious      Impervious      Total Area  "
"      Surface Area      7.120      0.000      7.120      hectare"
"      Time of concentration  20.504    2.747    20.504    minutes"
"      Time to Centroid    117.777  87.189   117.777   minutes"
"      Rainfall depth      97.921   97.921   97.921    mm"

```

		UnconEx_100yr			
"	Rainfall volume	6971.99	0.01	6972.00	c.m"
"	Rainfall losses	53.532	7.496	53.532	mm"
"	Runoff depth	44.389	90.426	44.389	mm"
"	Runoff volume	3160.50	0.01	3160.50	c.m"
"	Runoff coefficient	0.453	0.000	0.453	"
"	Maximum flow	0.985	0.000	0.985	c.m/sec"
40	HYDROGRAPH Add Runoff "				
"	4 Add Runoff "				
"	0.985 1.721 0.039 0.039"				
40	HYDROGRAPH Copy to Outflow"				
"	8 Copy to Outflow"				
"	0.985 1.721 1.721 0.039"				
40	HYDROGRAPH Combine 2"				
"	6 Combine "				
"	2 Node #"				
"	To Walser Street"				
"	Maximum flow	1.746		c.m/sec"	
"	Hydrograph volume	6762.568		c.m"	
"	0.985 1.721 1.721 1.746"				
40	HYDROGRAPH Start - New Tributary"				
"	2 Start - New Tributary"				
"	0.985 0.000 1.721 1.746"				
33	CATCHMENT 20"				
"	1 Triangular SCS"				
"	1 Equal length"				
"	1 SCS method"				
"	20 Catchment 20"				
"	0.000 % Impervious"				
"	6.650 Total Area"				
"	150.000 Flow length"				
"	2.000 Overland Slope"				
"	6.650 Pervious Area"				
"	150.000 Pervious length"				
"	2.000 Pervious slope"				
"	0.000 Impervious Area"				
"	150.000 Impervious length"				
"	2.000 Impervious slope"				
"	0.250 Pervious Manning 'n'"				
"	74.000 Pervious SCS Curve No."				
"	0.454 Pervious Runoff coefficient"				
"	0.100 Pervious Ia/S coefficient"				
"	8.924 Pervious Initial abstraction"				
"	0.015 Impervious Manning 'n'"				
"	98.000 Impervious SCS Curve No."				
"	0.000 Impervious Runoff coefficient"				
"	0.100 Impervious Ia/S coefficient"				
"	0.518 Impervious Initial abstraction"				
"	0.687 0.000 1.721 1.746 c.m/sec"				
"	Catchment 20 Pervious Impervious Total Area "				
"	Surface Area 6.650 0.000 6.650 hectare"				
"	Time of concentration 35.531 4.759 35.530 minutes"				
"	Time to Centroid 134.554 89.737 134.554 minutes"				
"	Rainfall depth 97.921 97.921 97.921 mm"				
"	Rainfall volume 6511.76 0.01 6511.77 c.m"				
"	Rainfall losses 53.501 6.084 53.501 mm"				
"	Runoff depth 44.420 91.837 44.420 mm"				
"	Runoff volume 2953.94 0.01 2953.94 c.m"				
"	Runoff coefficient 0.454 0.000 0.454 "				
"	Maximum flow 0.687 0.000 0.687 c.m/sec"				
40	HYDROGRAPH Add Runoff "				
"	4 Add Runoff "				
"	0.687 0.687 1.721 1.746"				
33	CATCHMENT 21"				

UnconEx_100yr

```

"      1 Triangular SCS"
"      1 Equal length"
"      1 SCS method"
"     21 Catchment 20"
"    10.000 % Impervious"
"      0.820 Total Area"
"    40.000 Flow length"
"      2.000 Overland Slope"
"      0.738 Pervious Area"
"    40.000 Pervious length"
"      2.000 Pervious slope"
"      0.082 Impervious Area"
"    40.000 Impervious length"
"      2.000 Impervious slope"
"      0.250 Pervious Manning 'n'"
"    74.000 Pervious SCS Curve No."
"      0.453 Pervious Runoff coefficient"
"      0.100 Pervious Ia/S coefficient"
"      8.924 Pervious Initial abstraction"
"      0.015 Impervious Manning 'n'"
"    98.000 Impervious SCS Curve No."
"      0.929 Impervious Runoff coefficient"
"      0.100 Impervious Ia/S coefficient"
"      0.518 Impervious Initial abstraction"
"          0.134      0.687      1.721      1.746 c.m/sec"
"      Catchment 21      Pervious      Impervious      Total Area "
"      Surface Area      0.738      0.082      0.820      hectare"
"      Time of concentration 16.076      2.153      13.490      minutes"
"      Time to Centroid      112.853      86.345      107.930      minutes"
"      Rainfall depth      97.921      97.921      97.921      mm"
"      Rainfall volume      722.66      80.30      802.95      c.m"
"      Rainfall losses      53.605      6.948      48.939      mm"
"      Runoff depth      44.316      90.973      48.982      mm"
"      Runoff volume      327.05      74.60      401.65      c.m"
"      Runoff coefficient      0.453      0.929      0.500      "
"      Maximum flow      0.115      0.034      0.134      c.m/sec"
" 40      HYDROGRAPH Add Runoff "
"      4      Add Runoff "
"          0.134      0.763      1.721      1.746"
" 40      HYDROGRAPH Copy to Outflow"
"      8      Copy to Outflow"
"          0.134      0.763      0.763      1.746"
" 40      HYDROGRAPH Combine 2"
"      6      Combine "
"      2      Node #"
"          To Walser Street"
"      Maximum flow      2.495      c.m/sec"
"      Hydrograph volume      10118.162      c.m"
"          0.134      0.763      0.763      2.495"
" 38      START/RE-START TOTALS 21"
"      3      Runoff Totals on EXIT"
"      Total Catchment area      22.700      hectare"
"      Total Impervious area      0.082      hectare"
"      Total % impervious      0.361"
" 19      EXIT"

```

UnconEx_REG

```

"          MIDUSS Output ----->"
"          MIDUSS version                Version 2.25 rev. 473"
"          MIDUSS created                 Sunday, February 07, 2010"
"          10 Units used:                  ie METRIC"
"          Job folder:                    w:\Kitchener\411-2011\411009\Design Data\
"                                         Modelling Files\2019-02-15\Uncontrolled"
"          Output filename:               UnconEx_REG.out"
"          Licensee name:                 gmbp"
"          Company                        Hewlett-Packard Company"
"          Date & Time last used:        2/15/2019 at 1:37:14 PM"
" 31          TIME PARAMETERS"
"          60.000 Time Step"
"          2880.000 Max. Storm length"
"          12000.000 Max. Hydrograph"
" 32          STORM Historic"
"          5 Historic"
"          2880.000 Duration"
"          48.000 Rainfall intensity values"
"                   2.028      2.028      2.028      2.028      2.028"
"                   2.028      2.028      2.028      2.028      2.028"
"                   2.028      2.028      2.028      2.028      2.028"
"                   2.028      2.028      2.028      2.028      2.028"
"                   2.028      2.028      2.028      2.028      2.028"
"                   2.028      2.026      2.026      2.026      2.028"
"                   2.026      6.000      4.000      6.000      13.000"
"                   17.000     13.000     23.000     13.000     13.000"
"                   53.000     38.000     13.000"
"          Maximum intensity                53.000 mm/hr"
"          Total depth                    285.000 mm"
" 33          6 200hyd Hydrograph extension used in this file"
"          CATCHMENT 30"
"          1 Triangular SCS"
"          1 Equal length"
"          1 SCS method"
"          30 Catchment 30"
"          0.000 % Impervious"
"          0.220 Total Area"
"          20.000 Flow length"
"          2.000 Overland Slope"
"          0.220 Pervious Area"
"          20.000 Pervious length"
"          2.000 Pervious slope"
"          0.000 Impervious Area"
"          20.000 Impervious length"
"          2.000 Impervious slope"
"          0.250 Pervious Manning 'n'"
"          74.000 Pervious SCS Curve No."
"          0.713 Pervious Runoff coefficient"
"          0.100 Pervious Ia/S coefficient"
"          8.924 Pervious Initial abstraction"
"          0.015 Impervious Manning 'n'"
"          98.000 Impervious SCS Curve No."
"          0.000 Impervious Runoff coefficient"
"          0.100 Impervious Ia/S coefficient"
"          0.518 Impervious Initial abstraction"
"                   0.024      0.000      0.000      0.000 c.m/sec"
"          Catchment 30      Pervious      Impervious      Total Area
"          Surface Area      0.220      0.000      0.220      hectare"
"          Time of concentration 12.633      2.243      12.633      minutes"
"          Time to Centroid 2530.545      2290.972      2530.545      minutes"
"          Rainfall depth      285.000      285.000      285.000      mm"
"          Rainfall volume      627.00      0.00      627.00      c.m"

```

		UnconEx_REG			
"	Rainfall losses	81.839	43.972	81.839	mm"
"	Runoff depth	203.161	241.028	203.161	mm"
"	Runoff volume	446.95	0.00	446.95	c.m"
"	Runoff coefficient	0.713	0.000	0.713	"
"	Maximum flow	0.024	0.000	0.024	c.m/sec"
" 40	HYDROGRAPH Add Runoff "				
"	4 Add Runoff "				
"	0.024 0.024 0.000 0.000"				
" 40	HYDROGRAPH Copy to Outflow"				
"	8 Copy to Outflow"				
"	0.024 0.024 0.024 0.000"				
" 40	HYDROGRAPH Combine 2"				
"	6 Combine "				
"	2 Node #"				
"	To Walser Street"				
"	Maximum flow 0.024 c.m/sec"				
"	Hydrograph volume 446.953 c.m"				
"	0.024 0.024 0.024 0.024"				
" 40	HYDROGRAPH Start - New Tributary"				
"	2 Start - New Tributary"				
"	0.024 0.000 0.024 0.024"				
" 33	CATCHMENT 10"				
"	1 Triangular SCS"				
"	1 Equal length"				
"	1 SCS method"				
"	10 Catchment 10"				
"	0.000 % Impervious"				
"	7.760 Total Area"				
"	150.000 Flow length"				
"	2.000 Overland Slope"				
"	7.760 Pervious Area"				
"	150.000 Pervious length"				
"	2.000 Pervious slope"				
"	0.000 Impervious Area"				
"	150.000 Impervious length"				
"	2.000 Impervious slope"				
"	0.250 Pervious Manning 'n'"				
"	74.000 Pervious SCS Curve No."				
"	0.714 Pervious Runoff coefficient"				
"	0.100 Pervious Ia/S coefficient"				
"	8.924 Pervious Initial abstraction"				
"	0.015 Impervious Manning 'n'"				
"	98.000 Impervious SCS Curve No."				
"	0.000 Impervious Runoff coefficient"				
"	0.100 Impervious Ia/S coefficient"				
"	0.518 Impervious Initial abstraction"				
"	0.881 0.000 0.024 0.024 c.m/sec"				
"	Catchment 10 Pervious Impervious Total Area "				
"	Surface Area 7.760 0.000 7.760 hectare"				
"	Time of concentration 42.319 7.513 42.319 minutes"				
"	Time to Centroid 2572.242 2276.224 2572.241 minutes"				
"	Rainfall depth 285.000 285.000 285.000 mm"				
"	Rainfall volume 2.2116 0.0000 2.2116 ha-m"				
"	Rainfall losses 81.644 25.621 81.644 mm"				
"	Runoff depth 203.356 259.379 203.356 mm"				
"	Runoff volume 1.5780 0.0000 1.5780 ha-m"				
"	Runoff coefficient 0.714 0.000 0.714 "				
"	Maximum flow 0.881 0.000 0.881 c.m/sec"				
" 40	HYDROGRAPH Add Runoff "				
"	4 Add Runoff "				
"	0.881 0.881 0.024 0.024"				
" 33	CATCHMENT 11"				
"	1 Triangular SCS"				

UnconEx_REG

```

"      1 Equal length"
"      1 SCS method"
"     11 Catchment 11"
"     0.000 % Impervious"
"     0.130 Total Area"
"    40.000 Flow length"
"     2.000 Overland Slope"
"     0.130 Pervious Area"
"    40.000 Pervious length"
"     2.000 Pervious slope"
"     0.000 Impervious Area"
"    40.000 Impervious length"
"     2.000 Impervious slope"
"     0.250 Pervious Manning 'n'"
"    74.000 Pervious SCS Curve No."
"     0.723 Pervious Runoff coefficient"
"     0.100 Pervious Ia/S coefficient"
"     8.924 Pervious Initial abstraction"
"     0.015 Impervious Manning 'n'"
"    98.000 Impervious SCS Curve No."
"     0.000 Impervious Runoff coefficient"
"     0.100 Impervious Ia/S coefficient"
"     0.518 Impervious Initial abstraction"
"           0.014      0.881      0.024      0.024 c.m/sec"
"      Catchment 11      Pervious      Impervious      Total Area      "
"      Surface Area      0.130      0.000      0.130      hectare"
"      Time of concentration 19.148      3.399      19.148      minutes"
"      Time to Centroid 2545.193      2266.333      2545.193      minutes"
"      Rainfall depth 285.000      285.000      285.000      mm"
"      Rainfall volume 370.50      0.00      370.50      c.m"
"      Rainfall losses 78.940      42.646      78.940      mm"
"      Runoff depth 206.060      242.354      206.060      mm"
"      Runoff volume 267.88      0.00      267.88      c.m"
"      Runoff coefficient 0.723      0.000      0.723      "
"      Maximum flow 0.014      0.000      0.014      c.m/sec"
" 40 HYDROGRAPH Add Runoff "
"      4 Add Runoff "
"           0.014      0.894      0.024      0.024"
" 33 CATCHMENT 40"
"      1 Triangular SCS"
"      1 Equal length"
"      1 SCS method"
"     40 Catchment 40"
"     0.000 % Impervious"
"     7.120 Total Area"
"    60.000 Flow length"
"     2.000 Overland Slope"
"     7.120 Pervious Area"
"    60.000 Pervious length"
"     2.000 Pervious slope"
"     0.000 Impervious Area"
"    60.000 Impervious length"
"     2.000 Impervious slope"
"     0.250 Pervious Manning 'n'"
"    74.000 Pervious SCS Curve No."
"     0.716 Pervious Runoff coefficient"
"     0.100 Pervious Ia/S coefficient"
"     8.924 Pervious Initial abstraction"
"     0.015 Impervious Manning 'n'"
"    98.000 Impervious SCS Curve No."
"     0.000 Impervious Runoff coefficient"
"     0.100 Impervious Ia/S coefficient"
"     0.518 Impervious Initial abstraction"

```

UnconEx_REG					
"	0.772	0.894	0.024	0.024	c.m/sec"
"	Catchment 40	Pervious	Impervious	Total Area	"
"	Surface Area	7.120	0.000	7.120	hectare"
"	Time of concentration	24.421	4.336	24.421	minutes"
"	Time to Centroid	2549.942	2258.969	2549.942	minutes"
"	Rainfall depth	285.000	285.000	285.000	mm"
"	Rainfall volume	2.0292	0.0000	2.0292	ha-m"
"	Rainfall losses	80.848	39.404	80.848	mm"
"	Runoff depth	204.152	245.596	204.152	mm"
"	Runoff volume	1.4536	0.0000	1.4536	ha-m"
"	Runoff coefficient	0.716	0.000	0.716	"
"	Maximum flow	0.772	0.000	0.772	c.m/sec"
40	HYDROGRAPH Add Runoff "				
"	4	Add Runoff "			
"	0.772	1.667	0.024	0.024"	
40	HYDROGRAPH Copy to Outflow"				
"	8	Copy to Outflow"			
"	0.772	1.667	1.667	0.024"	
40	HYDROGRAPH Combine 2"				
"	6	Combine "			
"	2	Node #"			
"	To Walser Street"				
"	Maximum flow		1.688	c.m/sec"	
"	Hydrograph volume		31030.850	c.m"	
"	0.772	1.667	1.667	1.688"	
40	HYDROGRAPH Start - New Tributary"				
"	2	Start - New Tributary"			
"	0.772	0.000	1.667	1.688"	
33	CATCHMENT 20"				
"	1	Triangular SCS"			
"	1	Equal length"			
"	1	SCS method"			
"	20	Catchment 20"			
"	0.000	% Impervious"			
"	6.650	Total Area"			
"	150.000	Flow length"			
"	2.000	Overland slope"			
"	6.650	Pervious Area"			
"	150.000	Pervious length"			
"	2.000	Pervious slope"			
"	0.000	Impervious Area"			
"	150.000	Impervious length"			
"	2.000	Impervious slope"			
"	0.250	Pervious Manning 'n'"			
"	74.000	Pervious SCS Curve No."			
"	0.714	Pervious Runoff coefficient"			
"	0.100	Pervious Ia/S coefficient"			
"	8.924	Pervious Initial abstraction"			
"	0.015	Impervious Manning 'n'"			
"	98.000	Impervious SCS Curve No."			
"	0.000	Impervious Runoff coefficient"			
"	0.100	Impervious Ia/S coefficient"			
"	0.518	Impervious Initial abstraction"			
"	0.755	0.000	1.667	1.688	c.m/sec"
"	Catchment 20	Pervious	Impervious	Total Area	"
"	Surface Area	6.650	0.000	6.650	hectare"
"	Time of concentration	42.319	7.513	42.319	minutes"
"	Time to Centroid	2572.242	2276.224	2572.241	minutes"
"	Rainfall depth	285.000	285.000	285.000	mm"
"	Rainfall volume	1.8952	0.0000	1.8952	ha-m"
"	Rainfall losses	81.644	25.621	81.644	mm"
"	Runoff depth	203.356	259.379	203.356	mm"
"	Runoff volume	1.3523	0.0000	1.3523	ha-m"

			UnConEx_REG		
"	Runoff coefficient	0.714	0.000	0.714	"
"	Maximum flow	0.755	0.000	0.755	c.m/sec"
" 40	HYDROGRAPH Add Runoff "				
"	4 Add Runoff "				
"		0.755	0.755	1.667	1.688"
" 33	CATCHMENT 21"				
"	1 Triangular SCS"				
"	1 Equal length"				
"	1 SCS method"				
"	21 Catchment 20"				
"	10.000 % Impervious"				
"	0.820 Total Area"				
"	40.000 Flow length"				
"	2.000 Overland slope"				
"	0.738 Pervious Area"				
"	40.000 Pervious length"				
"	2.000 Pervious slope"				
"	0.082 Impervious Area"				
"	40.000 Impervious length"				
"	2.000 Impervious slope"				
"	0.250 Pervious Manning 'n'"				
"	74.000 Pervious SCS Curve No."				
"	0.723 Pervious Runoff coefficient"				
"	0.100 Pervious Ia/S coefficient"				
"	8.924 Pervious Initial abstraction"				
"	0.015 Impervious Manning 'n'"				
"	98.000 Impervious SCS Curve No."				
"	0.850 Impervious Runoff coefficient"				
"	0.100 Impervious Ia/S coefficient"				
"	0.518 Impervious Initial abstraction"				
"		0.087	0.755	1.667	1.688 c.m/sec"
"	Catchment 21	Pervious	Impervious	Total Area	"
"	Surface Area	0.738	0.082	0.820	hectare"
"	Time of concentration	19.148	3.399	17.327	minutes"
"	Time to Centroid	2545.193	2266.333	2512.963	minutes"
"	Rainfall depth	285.000	285.000	285.000	mm"
"	Rainfall volume	2103.30	233.70	2337.00	c.m"
"	Rainfall losses	78.940	42.646	75.310	mm"
"	Runoff depth	206.060	242.354	209.690	mm"
"	Runoff volume	1520.72	198.73	1719.45	c.m"
"	Runoff coefficient	0.723	0.850	0.736	"
"	Maximum flow	0.078	0.010	0.087	c.m/sec"
" 40	HYDROGRAPH Add Runoff "				
"	4 Add Runoff "				
"		0.087	0.840	1.667	1.688"
" 40	HYDROGRAPH Copy to Outflow"				
"	8 Copy to Outflow"				
"		0.087	0.840	0.840	1.688"
" 40	HYDROGRAPH Combine 2"				
"	6 Combine "				
"	2 Node #"				
"	To Walser Street"				
"	Maximum flow		2.528	c.m/sec"	
"	Hydrograph volume		46273.457	c.m"	
"		0.087	0.840	0.840	2.528"
" 38	START/RE-START TOTALS 21"				
"	3 Runoff Totals on EXIT"				
"	Total Catchment area			22.700	hectare"
"	Total Impervious area			0.082	hectare"
"	Total % impervious			0.361"	
" 19	EXIT"				

```

Existing__2yr
" MIDUSS Output ----->"
" MIDUSS version Version 2.25 rev. 473"
" MIDUSS created Sunday, February 07, 2010"
" 10 Units used: ie METRIC"
" Job folder: w:\kitchener\411-2011\411009\Design Data\
Modelling Files\2019-02-15"
" Output filename: Existing__2yr.out"
" Licensee name: gmbp"
" Company Hewlett-Packard Company"
" Date & Time last used: 2/15/2019 at 1:58:44 PM"
31 TIME PARAMETERS"
" 5.000 Time Step"
" 180.000 Max. Storm length"
" 3600.000 Max. Hydrograph"
32 STORM Chicago storm"
" 1 Chicago storm"
" 695.050 Coefficient A"
" 6.387 Constant B"
" 0.793 Exponent C"
" 0.380 Fraction R"
" 180.000 Duration"
" 1.000 Time step multiplier"
" Maximum intensity 93.293 mm/hr"
" Total depth 33.014 mm"
33 6 002hyd Hydrograph extension used in this file"
CATCHMENT 30"
" 1 Triangular SCS"
" 1 Equal length"
" 1 SCS method"
" 30 Catchment 30"
" 0.000 % Impervious"
" 0.220 Total Area"
" 20.000 Flow length"
" 2.000 Overland slope"
" 0.220 Pervious Area"
" 20.000 Pervious length"
" 2.000 Pervious slope"
" 0.000 Impervious Area"
" 20.000 Impervious length"
" 2.000 Impervious slope"
" 0.250 Pervious Manning 'n'"
" 74.000 Pervious SCS Curve No."
" 0.155 Pervious Runoff coefficient"
" 0.100 Pervious Ia/S coefficient"
" 8.924 Pervious Initial abstraction"
" 0.015 Impervious Manning 'n'"
" 98.000 Impervious SCS Curve No."
" 0.000 Impervious Runoff coefficient"
" 0.100 Impervious Ia/S coefficient"
" 0.518 Impervious Initial abstraction"
" 0.003 0.000 0.000 0.000 c.m/sec"
" Catchment 30 Pervious Impervious Total Area "
" Surface Area 0.220 0.000 0.220 hectare"
" Time of concentration 23.304 1.868 23.304 minutes"
" Time to Centroid 130.781 88.659 130.781 minutes"
" Rainfall depth 33.014 33.014 33.014 mm"
" Rainfall volume 72.63 0.00 72.63 c.m"
" Rainfall losses 27.898 5.363 27.898 mm"
" Runoff depth 5.116 27.651 5.116 mm"
" Runoff volume 11.26 0.00 11.26 c.m"
" Runoff coefficient 0.155 0.000 0.155 "
" Maximum flow 0.003 0.000 0.003 c.m/sec"
40 HYDROGRAPH Add Runoff "

```

```

Existing__2yr
"      4  Add Runoff "
"      0.003      0.003      0.000      0.000"
" 40  HYDROGRAPH Copy to Outflow"
"      8  Copy to Outflow"
"      0.003      0.003      0.003      0.000"
" 40  HYDROGRAPH Combine 2"
"      6  Combine "
"      2  Node #"
"      To Walser Street"
"      Maximum flow      0.003      c.m/sec"
"      Hydrograph volume      11.255      c.m"
"      0.003      0.003      0.003      0.003"
" 40  HYDROGRAPH Start - New Tributary"
"      2  Start - New Tributary"
"      0.003      0.000      0.003      0.003"
" 33  CATCHMENT 10"
"      1  Triangular SCS"
"      1  Equal length"
"      1  SCS method"
"      10  Catchment 10"
"      0.000  % Impervious"
"      7.760  Total Area"
"      150.000  Flow length"
"      2.000  Overland Slope"
"      7.760  Pervious Area"
"      150.000  Pervious length"
"      2.000  Pervious slope"
"      0.000  Impervious Area"
"      150.000  Impervious length"
"      2.000  Impervious slope"
"      0.250  Pervious Manning 'n'"
"      74.000  Pervious SCS Curve No."
"      0.155  Pervious Runoff coefficient"
"      0.100  Pervious Ia/S coefficient"
"      8.924  Pervious Initial abstraction"
"      0.015  Impervious Manning 'n'"
"      98.000  Impervious SCS Curve No."
"      0.000  Impervious Runoff coefficient"
"      0.100  Impervious Ia/S coefficient"
"      0.518  Impervious Initial abstraction"
"      0.044      0.000      0.003      0.003 c.m/sec"
"      Catchment 10      Pervious      Impervious      Total Area "
"      Surface Area      7.760      0.000      7.760      hectare"
"      Time of concentration      78.068      6.258      78.068      minutes"
"      Time to Centroid      195.540      95.197      195.540      minutes"
"      Rainfall depth      33.014      33.014      33.014      mm"
"      Rainfall volume      2561.88      0.00      2561.88      c.m"
"      Rainfall losses      27.894      5.228      27.894      mm"
"      Runoff depth      5.120      27.786      5.120      mm"
"      Runoff volume      397.31      0.00      397.31      c.m"
"      Runoff coefficient      0.155      0.000      0.155      "
"      Maximum flow      0.044      0.000      0.044      c.m/sec"
" 40  HYDROGRAPH Add Runoff "
"      4  Add Runoff "
"      0.044      0.044      0.003      0.003"
" 33  CATCHMENT 11"
"      1  Triangular SCS"
"      1  Equal length"
"      1  SCS method"
"      11  Catchment 11"
"      0.000  % Impervious"
"      0.130  Total Area"
"      40.000  Flow length"

```

Existing__2yr

"	2.000	Overland Slope"				
"	0.130	Pervious Area"				
"	40.000	Pervious length"				
"	2.000	Pervious slope"				
"	0.000	Impervious Area"				
"	40.000	Impervious length"				
"	2.000	Impervious slope"				
"	0.250	Pervious Manning 'n'"				
"	74.000	Pervious SCS Curve No."				
"	0.155	Pervious Runoff coefficient"				
"	0.100	Pervious Ia/S coefficient"				
"	8.924	Pervious Initial abstraction"				
"	0.015	Impervious Manning 'n'"				
"	98.000	Impervious SCS Curve No."				
"	0.000	Impervious Runoff coefficient"				
"	0.100	Impervious Ia/S coefficient"				
"	0.518	Impervious Initial abstraction"				
"		0.001	0.044	0.003	0.003 c.m/sec"	
"		Catchment 11	Pervious	Impervious	Total Area	"
"		Surface Area	0.130	0.000	0.130	hectare"
"		Time of concentration	35.323	2.832	35.323	minutes"
"		Time to Centroid	144.986	90.217	144.986	minutes"
"		Rainfall depth	33.014	33.014	33.014	mm"
"		Rainfall volume	42.92	0.00	42.92	c.m"
"		Rainfall losses	27.897	5.467	27.897	mm"
"		Runoff depth	5.117	27.547	5.117	mm"
"		Runoff volume	6.65	0.00	6.65	c.m"
"		Runoff coefficient	0.155	0.000	0.155	"
"		Maximum flow	0.001	0.000	0.001	c.m/sec"
" 40		HYDROGRAPH Add Runoff "				
"	4	Add Runoff "				
"		0.001	0.045	0.003	0.003"	
" 33		CATCHMENT 40"				
"	1	Triangular SCS"				
"	1	Equal length"				
"	1	SCS method"				
"	40	Catchment 40"				
"	0.000	% Impervious"				
"	7.120	Total Area"				
"	60.000	Flow length"				
"	2.000	Overland Slope"				
"	7.120	Pervious Area"				
"	60.000	Pervious length"				
"	2.000	Pervious slope"				
"	0.000	Impervious Area"				
"	60.000	Impervious length"				
"	2.000	Impervious slope"				
"	0.250	Pervious Manning 'n'"				
"	74.000	Pervious SCS Curve No."				
"	0.155	Pervious Runoff coefficient"				
"	0.100	Pervious Ia/S coefficient"				
"	8.924	Pervious Initial abstraction"				
"	0.015	Impervious Manning 'n'"				
"	98.000	Impervious SCS Curve No."				
"	0.000	Impervious Runoff coefficient"				
"	0.100	Impervious Ia/S coefficient"				
"	0.518	Impervious Initial abstraction"				
"		0.060	0.045	0.003	0.003 c.m/sec"	
"		Catchment 40	Pervious	Impervious	Total Area	"
"		Surface Area	7.120	0.000	7.120	hectare"
"		Time of concentration	45.052	3.611	45.051	minutes"
"		Time to Centroid	156.495	91.497	156.495	minutes"
"		Rainfall depth	33.014	33.014	33.014	mm"

```

Existing__2yr
"      Rainfall volume      2350.59      0.00      2350.59      c.m"
"      Rainfall losses      27.895      5.642      27.895      mm"
"      Runoff depth         5.119      27.372      5.119      mm"
"      Runoff volume        364.45      0.00      364.45      c.m"
"      Runoff coefficient    0.155      0.000      0.155      "
"      Maximum flow         0.060      0.000      0.060      c.m/sec"
40     HYDROGRAPH Add Runoff "
"      4 Add Runoff "
"      0.060      0.099      0.003      0.003"
54     POND DESIGN"
"      0.099 Current peak flow c.m/sec"
"      0.050 Target outflow c.m/sec"
"      768.4 Hydrograph volume c.m"
"      6 Number of stages"
"      409.630 Minimum water level metre"
"      410.750 Maximum water level metre"
"      409.630 Starting water level metre"
"      0 Keep Design Data: 1 = True; 0 = False"
"      Level Discharge Volume"
"      409.630 0.000 0.000"
"      409.750 0.6650 402.200"
"      410.000 3.601 2187.900"
"      410.250 7.811 5318.900"
"      410.500 12.984 9642.300"
"      410.750 18.965 15227.70"
"      Peak outflow 0.095 c.m/sec"
"      Maximum level 409.647 metre"
"      Maximum storage 57.616 c.m"
"      Centroidal lag 3.111 hours"
"      0.060 0.099 0.095 0.003 c.m/sec"
40     HYDROGRAPH Next link "
"      5 Next link "
"      0.060 0.095 0.095 0.003"
52     CHANNEL DESIGN"
"      0.095 Current peak flow c.m/sec"
"      0.035 Manning 'n'"
"      0 Cross-section type: 0=trapezoidal; 1=general"
"      0.000 Basewidth metre"
"      7.410 Left bank slope"
"      6.000 Right bank slope"
"      0.950 Channel depth metre"
"      1.040 Gradient %"
"      Depth of flow 0.162 metre"
"      Velocity 0.541 m/sec"
"      Channel capacity 10.655 c.m/sec"
"      Critical depth 0.133 metre"
53     ROUTE Channel Route 72"
"      72.40 Channel Route 72 Reach length (metre)"
"      0.460 X-factor <= 0.5"
"      100.360 K-lag (seconds)"
"      0.000 Default(0) or user spec.(1) values used"
"      0.500 X-factor <= 0.5"
"      30.000 K-lag (seconds)"
"      0.500 Beta weighting factor"
"      100.000 Routing time step (seconds)"
"      1 No. of sub-reaches"
"      Peak outflow 0.095 c.m/sec"
"      0.060 0.095 0.095 0.003 c.m/sec"
40     HYDROGRAPH Next link "
"      5 Next link "
"      0.060 0.095 0.095 0.003"
52     CHANNEL DESIGN"
"      0.095 Current peak flow c.m/sec"

```



```

Existing__2yr
"      0.035  Manning 'n'"
"      0.      Cross-section type: 0=trapezoidal; 1=general"
"      2.000  Basewidth      metre"
"      2.950  Left bank slope"
"      3.000  Right bank slope"
"      0.950  Channel depth      metre"
"      1.040  Gradient      %"
"      Depth of flow      0.083      metre"
"      Velocity      0.512      m/sec"
"      Channel capacity      9.246      c.m/sec"
"      Critical depth      0.059      metre"
53  ROUTE      Channel Route 40"
"      39.80      Channel Route 40 Reach length      ( metre)"
"      0.442  X-factor <= 0.5"
"      58.297  K-lag      ( seconds)"
"      0.000  Default(0) or user spec.(1) values used"
"      0.500  X-factor <= 0.5"
"      30.000  K-lag      ( seconds)"
"      0.500  Beta weighting factor"
"      60.000  Routing time step      ( seconds)"
"      1      No. of sub-reaches"
"      Peak outflow      0.095      c.m/sec"
"      0.060      0.095      0.095      0.003 c.m/sec"
40  HYDROGRAPH Next link "
"      5      Next link "
"      0.060      0.095      0.095      0.003"
40  HYDROGRAPH Copy to Outflow"
"      8      Copy to Outflow"
"      0.060      0.095      0.095      0.003"
40  HYDROGRAPH Combine 1"
"      6      Combine "
"      1      Node #"
"      Total"
"      Maximum flow      0.095      c.m/sec"
"      Hydrograph volume      768.416      c.m"
"      0.060      0.095      0.095      0.095"
40  HYDROGRAPH Start - New Tributary"
"      2      Start - New Tributary"
"      0.060      0.000      0.095      0.095"
33  CATCHMENT 20"
"      1      Triangular SCS"
"      1      Equal length"
"      1      SCS method"
"      20      Catchment 20"
"      0.000  % Impervious"
"      6.650  Total Area"
"      150.000  Flow length"
"      2.000  Overland Slope"
"      6.650  Pervious Area"
"      150.000  Pervious length"
"      2.000  Pervious slope"
"      0.000  Impervious Area"
"      150.000  Impervious length"
"      2.000  Impervious slope"
"      0.250  Pervious Manning 'n'"
"      74.000  Pervious SCS Curve No."
"      0.155  Pervious Runoff coefficient"
"      0.100  Pervious Ia/S coefficient"
"      8.924  Pervious Initial abstraction"
"      0.015  Impervious Manning 'n'"
"      98.000  Impervious SCS Curve No."
"      0.000  Impervious Runoff coefficient"
"      0.100  Impervious Ia/S coefficient"

```

		Existing__2yr				
"	0.518	Impervious	Initial abstraction"			
"		0.038	0.000	0.095	0.095	c.m/sec"
"		Catchment 20	Pervious	Impervious	Total Area	"
"		Surface Area	6.650	0.000	6.650	hectare"
"		Time of concentration	78.068	6.258	78.068	minutes"
"		Time to Centroid	195.540	95.197	195.539	minutes"
"		Rainfall depth	33.014	33.014	33.014	mm"
"		Rainfall volume	2195.43	0.00	2195.43	c.m"
"		Rainfall losses	27.894	5.228	27.894	mm"
"		Runoff depth	5.120	27.786	5.120	mm"
"		Runoff volume	340.48	0.00	340.48	c.m"
"		Runoff coefficient	0.155	0.000	0.155	"
"		Maximum flow	0.038	0.000	0.038	c.m/sec"
" 40		HYDROGRAPH Add Runoff "				
"	4	Add Runoff "				
"		0.038	0.038	0.095	0.095"	
" 33		CATCHMENT 21"				
"	1	Triangular SCS"				
"	1	Equal length"				
"	1	SCS method"				
"	21	Catchment 20"				
"	10.000	% Impervious"				
"	0.820	Total Area"				
"	40.000	Flow length"				
"	2.000	Overland Slope"				
"	0.738	Pervious Area"				
"	40.000	Pervious length"				
"	2.000	Pervious slope"				
"	0.082	Impervious Area"				
"	40.000	Impervious length"				
"	2.000	Impervious slope"				
"	0.250	Pervious Manning 'n'"				
"	74.000	Pervious SCS Curve No."				
"	0.155	Pervious Runoff coefficient"				
"	0.100	Pervious Ia/S coefficient"				
"	8.924	Pervious Initial abstraction"				
"	0.015	Impervious Manning 'n'"				
"	98.000	Impervious SCS Curve No."				
"	0.834	Impervious Runoff coefficient"				
"	0.100	Impervious Ia/S coefficient"				
"	0.518	Impervious Initial abstraction"				
"		0.016	0.038	0.095	0.095	c.m/sec"
"		Catchment 21	Pervious	Impervious	Total Area	"
"		Surface Area	0.738	0.082	0.820	hectare"
"		Time of concentration	35.323	2.832	23.162	minutes"
"		Time to Centroid	144.986	90.217	124.487	minutes"
"		Rainfall depth	33.014	33.014	33.014	mm"
"		Rainfall volume	243.64	27.07	270.71	c.m"
"		Rainfall losses	27.897	5.467	25.654	mm"
"		Runoff depth	5.117	27.547	7.360	mm"
"		Runoff volume	37.76	22.59	60.35	c.m"
"		Runoff coefficient	0.155	0.834	0.223	"
"		Maximum flow	0.007	0.015	0.016	c.m/sec"
" 40		HYDROGRAPH Add Runoff "				
"	4	Add Runoff "				
"		0.016	0.043	0.095	0.095"	
" 40		HYDROGRAPH Copy to Outflow"				
"	8	Copy to Outflow"				
"		0.016	0.043	0.043	0.095"	
" 64		SHOW TABLE"				
"	2	Flow hydrograph"				
"	4	Inflow Hydrograph"				
"		Maximum flow		0.043	c.m/sec"	

"			Existing_2yr		
"	40	Hydrograph volume	400.831		c.m"
"		HYDROGRAPH	Combine	1"	
"		6	Combine	"	
"		1	Node #"		
"			Total"		
"		Maximum flow	0.138		c.m/sec"
"		Hydrograph volume	1169.246		c.m"
"			0.016	0.043	
"			0.043		0.138"
"	38	START/RE-START TOTALS	21"		
"		3	Runoff Totals on EXIT"		
"		Total Catchment area		22.700	hectare"
"		Total Impervious area		0.082	hectare"
"		Total % impervious		0.361"	
"	19	EXIT"			

```

Existing__5yr
"
"      MIDUSS Output ----->"
"      MIDUSS version          Version 2.25 rev. 473"
"      MIDUSS created          Sunday, February 07, 2010"
"      10  Units used:          ie METRIC"
"      Job folder:             w:\Kitchener\411-2011\411009\Design Data\
"                                  Modelling Files\2019-02-15"
"      Output filename:       Existing__5yr.out"
"      Licensee name:         gmbp"
"      Company                 Hewlett-Packard Company"
"      Date & Time last used: 2/15/2019 at 2:01:12 PM"
" 31  TIME PARAMETERS"
"      5.000 Time Step"
"      180.000 Max. Storm length"
"      3600.000 Max. Hydrograph"
" 32  STORM Chicago storm"
"      1 Chicago storm"
"      1459.072 Coefficient A"
"      13.690 Constant B"
"      0.850 Exponent C"
"      0.380 Fraction R"
"      180.000 Duration"
"      1.000 Time step multiplier"
"      Maximum intensity      113.586 mm/hr"
"      Total depth            49.792 mm"
"      6 005hyd Hydrograph extension used in this file"
" 33  CATCHMENT 30"
"      1 Triangular SCS"
"      1 Equal length"
"      1 SCS method"
"      30 Catchment 30"
"      0.000 % Impervious"
"      0.220 Total Area"
"      20.000 Flow length"
"      2.000 Overland slope"
"      0.220 Pervious Area"
"      20.000 Pervious length"
"      2.000 Pervious slope"
"      0.000 Impervious Area"
"      20.000 Impervious length"
"      2.000 Impervious slope"
"      0.250 Pervious Manning 'n'"
"      74.000 Pervious SCS Curve No."
"      0.257 Pervious Runoff coefficient"
"      0.100 Pervious Ia/S coefficient"
"      8.924 Pervious Initial abstraction"
"      0.015 Impervious Manning 'n'"
"      98.000 Impervious SCS Curve No."
"      0.000 Impervious Runoff coefficient"
"      0.100 Impervious Ia/S coefficient"
"      0.518 Impervious Initial abstraction"
"      0.009      0.000      0.000      0.000 c.m/sec"
"      Catchment 30      Pervious      Impervious      Total Area
"      Surface Area      0.220      0.000      0.220      hectare"
"      Time of concentration 16.417      1.691      16.417      minutes"
"      Time to Centroid    118.292      87.210      118.292      minutes"
"      Rainfall depth     49.792      49.792      49.792      mm"
"      Rainfall volume    109.54      0.00      109.54      c.m"
"      Rainfall losses    36.983      5.811      36.983      mm"
"      Runoff depth       12.809      43.981      12.809      mm"
"      Runoff volume      28.18      0.00      28.18      c.m"
"      Runoff coefficient  0.257      0.000      0.257      "
"      Maximum flow      0.009      0.000      0.009      c.m/sec"
" 40  HYDROGRAPH Add Runoff "

```

```

Existing__5yr
"      4  Add Runoff "
"      0.009  0.009  0.000  0.000"
" 40  HYDROGRAPH Copy to Outflow"
"      8  Copy to Outflow"
"      0.009  0.009  0.009  0.000"
" 40  HYDROGRAPH Combine 2"
"      6  Combine "
"      2  Node #"
"      To Walser Street"
"      Maximum flow 0.009 c.m/sec"
"      Hydrograph volume 28.179 c.m"
"      0.009  0.009  0.009  0.009"
" 40  HYDROGRAPH Start - New Tributary"
"      2  Start - New Tributary"
"      0.009  0.000  0.009  0.009"
" 33  CATCHMENT 10"
"      1  Triangular SCS"
"      1  Equal length"
"      1  SCS method"
"      10  Catchment 10"
"      0.000  % Impervious"
"      7.760  Total Area"
"      150.000  Flow length"
"      2.000  Overland Slope"
"      7.760  Pervious Area"
"      150.000  Pervious length"
"      2.000  Pervious slope"
"      0.000  Impervious Area"
"      150.000  Impervious length"
"      2.000  Impervious slope"
"      0.250  Pervious Manning 'n'"
"      74.000  Pervious SCS Curve No."
"      0.258  Pervious Runoff coefficient"
"      0.100  Pervious Ia/S coefficient"
"      8.924  Pervious Initial abstraction"
"      0.015  Impervious Manning 'n'"
"      98.000  Impervious SCS Curve No."
"      0.000  Impervious Runoff coefficient"
"      0.100  Impervious Ia/S coefficient"
"      0.518  Impervious Initial abstraction"
"      0.157  0.000  0.009  0.009 c.m/sec"
"      Catchment 10 Pervious Impervious Total Area "
"      Surface Area 7.760 0.000 7.760 hectare"
"      Time of concentration 54.995 5.665 54.994 minutes"
"      Time to Centroid 162.955 92.780 162.955 minutes"
"      Rainfall depth 49.792 49.792 49.792 mm"
"      Rainfall volume 3863.83 0.00 3863.84 c.m"
"      Rainfall losses 36.958 5.466 36.958 mm"
"      Runoff depth 12.834 44.325 12.834 mm"
"      Runoff volume 995.89 0.00 995.90 c.m"
"      Runoff coefficient 0.258 0.000 0.258 "
"      Maximum flow 0.157 0.000 0.157 c.m/sec"
" 40  HYDROGRAPH Add Runoff "
"      4  Add Runoff "
"      0.157  0.157  0.009  0.009"
" 33  CATCHMENT 11"
"      1  Triangular SCS"
"      1  Equal length"
"      1  SCS method"
"      11  Catchment 11"
"      0.000  % Impervious"
"      0.130  Total Area"
"      40.000  Flow length"

```

Existing__5yr

"	2.000	Overland Slope"				
"	0.130	Pervious Area"				
"	40.000	Pervious length"				
"	2.000	Pervious slope"				
"	0.000	Impervious Area"				
"	40.000	Impervious length"				
"	2.000	Impervious slope"				
"	0.250	Pervious Manning 'n'"				
"	74.000	Pervious SCS Curve No."				
"	0.258	Pervious Runoff coefficient"				
"	0.100	Pervious Ia/S coefficient"				
"	8.924	Pervious Initial abstraction"				
"	0.015	Impervious Manning 'n'"				
"	98.000	Impervious SCS Curve No."				
"	0.000	Impervious Runoff coefficient"				
"	0.100	Impervious Ia/S coefficient"				
"	0.518	Impervious Initial abstraction"				
"		0.004	0.157	0.009	0.009 c.m/sec"	
"		Catchment 11	Pervious	Impervious	Total Area	"
"		Surface Area	0.130	0.000	0.130	hectare"
"		Time of concentration	24.883	2.563	24.883	minutes"
"		Time to Centroid	128.082	88.517	128.082	minutes"
"		Rainfall depth	49.792	49.792	49.792	mm"
"		Rainfall volume	64.73	0.00	64.73	c.m"
"		Rainfall losses	36.970	6.066	36.969	mm"
"		Runoff depth	12.822	43.726	12.822	mm"
"		Runoff volume	16.67	0.00	16.67	c.m"
"		Runoff coefficient	0.258	0.000	0.258	"
"		Maximum flow	0.004	0.000	0.004	c.m/sec"
" 40		HYDROGRAPH Add Runoff "				
"	4	Add Runoff "				
"		0.004	0.159	0.009	0.009"	
" 33		CATCHMENT 40"				
"	1	Triangular SCS"				
"	1	Equal length"				
"	1	SCS method"				
"	40	Catchment 40"				
"	0.000	% Impervious"				
"	7.120	Total Area"				
"	60.000	Flow length"				
"	2.000	Overland Slope"				
"	7.120	Pervious Area"				
"	60.000	Pervious length"				
"	2.000	Pervious slope"				
"	0.000	Impervious Area"				
"	60.000	Impervious length"				
"	2.000	Impervious slope"				
"	0.250	Pervious Manning 'n'"				
"	74.000	Pervious SCS Curve No."				
"	0.258	Pervious Runoff coefficient"				
"	0.100	Pervious Ia/S coefficient"				
"	8.924	Pervious Initial abstraction"				
"	0.015	Impervious Manning 'n'"				
"	98.000	Impervious SCS Curve No."				
"	0.000	Impervious Runoff coefficient"				
"	0.100	Impervious Ia/S coefficient"				
"	0.518	Impervious Initial abstraction"				
"		0.209	0.159	0.009	0.009 c.m/sec"	
"		Catchment 40	Pervious	Impervious	Total Area	"
"		Surface Area	7.120	0.000	7.120	hectare"
"		Time of concentration	31.736	3.269	31.736	minutes"
"		Time to Centroid	136.024	89.581	136.024	minutes"
"		Rainfall depth	49.792	49.792	49.792	mm"

```

Existing__5yr
" Rainfall volume 3545.16 0.00 3545.17 c.m"
" Rainfall losses 36.968 6.236 36.968 mm"
" Runoff depth 12.824 43.556 12.824 mm"
" Runoff volume 913.04 0.00 913.04 c.m"
" Runoff coefficient 0.258 0.000 0.258 "
" Maximum flow 0.209 0.000 0.209 c.m/sec"
40 HYDROGRAPH Add Runoff "
" 4 Add Runoff "
" 0.209 0.353 0.009 0.009"
54 POND DESIGN"
" 0.353 Current peak flow c.m/sec"
" 0.050 Target outflow c.m/sec"
" 1925.6 Hydrograph volume c.m"
" 6 Number of stages"
" 409.630 Minimum water level metre"
" 410.750 Maximum water level metre"
" 409.630 Starting water level metre"
" 0 Keep Design Data: 1 = True; 0 = False"
" Level Discharge volume"
" 409.630 0.000 0.000"
" 409.750 0.6650 402.200"
" 410.000 3.601 2187.900"
" 410.250 7.811 5318.900"
" 410.500 12.984 9642.300"
" 410.750 18.965 15227.70"
" Peak outflow 0.324 c.m/sec"
" Maximum level 409.688 metre"
" Maximum storage 195.955 c.m"
" Centroidal lag 2.666 hours"
" 0.209 0.353 0.324 0.009 c.m/sec"
40 HYDROGRAPH Next link "
" 5 Next link "
" 0.209 0.324 0.324 0.009"
52 CHANNEL DESIGN"
" 0.324 Current peak flow c.m/sec"
" 0.035 Manning 'n'"
" 0 Cross-section type: 0=trapezoidal; 1=general"
" 0.000 Basewidth metre"
" 7.410 Left bank slope"
" 6.000 Right bank slope"
" 0.950 Channel depth metre"
" 1.040 Gradient %"
" Depth of flow 0.256 metre"
" Velocity 0.735 m/sec"
" Channel capacity 10.655 c.m/sec"
" Critical depth 0.217 metre"
53 ROUTE Channel Route 72"
" 72.40 Channel Route 72 Reach length (metre)"
" 0.436 X-factor <= 0.5"
" 73.851 K-lag (seconds)"
" 0.000 Default(0) or user spec.(1) values used"
" 0.500 X-factor <= 0.5"
" 30.000 K-lag (seconds)"
" 0.500 Beta weighting factor"
" 75.000 Routing time step (seconds)"
" 1 No. of sub-reaches"
" Peak outflow 0.323 c.m/sec"
" 0.209 0.324 0.323 0.009 c.m/sec"
40 HYDROGRAPH Next link "
" 5 Next link "
" 0.209 0.323 0.323 0.009"
52 CHANNEL DESIGN"
" 0.323 Current peak flow c.m/sec"

```

```

Existing__5yr
"      0.035 Manning 'n'"
"      0.      Cross-section type: 0=trapezoidal; 1=general"
"      2.000 Basewidth      metre"
"      2.950 Left bank slope"
"      3.000 Right bank slope"
"      0.950 Channel depth      metre"
"      1.040 Gradient      %"
"      Depth of flow      0.167      metre"
"      Velocity      0.774      m/sec"
"      Channel capacity      9.246      c.m/sec"
"      Critical depth      0.129      metre"
53  ROUTE      Channel Route 40"
"      39.80      Channel Route 40 Reach length      ( metre)"
"      0.386 X-factor <= 0.5"
"      38.571 K-lag      ( seconds)"
"      0.000 Default(0) or user spec.(1) values used"
"      0.500 X-factor <= 0.5"
"      30.000 K-lag      ( seconds)"
"      0.500 Beta weighting factor"
"      42.857 Routing time step      ( seconds)"
"      1 No. of sub-reaches"
"      Peak outflow      0.322      c.m/sec"
"      0.209      0.323      0.322      0.009 c.m/sec"
40  HYDROGRAPH Next link "
"      5 Next link "
"      0.209      0.322      0.322      0.009"
40  HYDROGRAPH Copy to Outflow"
"      8 Copy to Outflow"
"      0.209      0.322      0.322      0.009"
40  HYDROGRAPH Combine      1"
"      6 Combine "
"      1 Node #"
"      Total"
"      Maximum flow      0.322      c.m/sec"
"      Hydrograph volume      1925.607      c.m"
"      0.209      0.322      0.322      0.322"
40  HYDROGRAPH Start - New Tributary"
"      2 Start - New Tributary"
"      0.209      0.000      0.322      0.322"
33  CATCHMENT 20"
"      1 Triangular SCS"
"      1 Equal length"
"      1 SCS method"
"      20 Catchment 20"
"      0.000 % Impervious"
"      6.650 Total Area"
"      150.000 Flow length"
"      2.000 Overland Slope"
"      6.650 Pervious Area"
"      150.000 Pervious length"
"      2.000 Pervious slope"
"      0.000 Impervious Area"
"      150.000 Impervious length"
"      2.000 Impervious slope"
"      0.250 Pervious Manning 'n'"
"      74.000 Pervious SCS Curve No."
"      0.258 Pervious Runoff coefficient"
"      0.100 Pervious Ia/S coefficient"
"      8.924 Pervious Initial abstraction"
"      0.015 Impervious Manning 'n'"
"      98.000 Impervious SCS Curve No."
"      0.000 Impervious Runoff coefficient"
"      0.100 Impervious Ia/S coefficient"

```



```

Existing__5yr
" 0.518 Impervious Initial abstraction"
" 0.135 0.000 0.322 0.322 c.m/sec"
" Catchment 20 Pervious Impervious Total Area "
" Surface Area 6.650 0.000 6.650 hectare"
" Time of concentration 54.995 5.665 54.994 minutes"
" Time to Centroid 162.956 92.780 162.955 minutes"
" Rainfall depth 49.792 49.792 49.792 mm"
" Rainfall volume 3311.14 0.00 3311.15 c.m"
" Rainfall losses 36.958 5.466 36.958 mm"
" Runoff depth 12.834 44.325 12.834 mm"
" Runoff volume 853.44 0.00 853.44 c.m"
" Runoff coefficient 0.258 0.000 0.258 "
" Maximum flow 0.135 0.000 0.135 c.m/sec"
40 HYDROGRAPH Add Runoff "
4 Add Runoff "
" 0.135 0.135 0.322 0.322"
33 CATCHMENT 21"
1 Triangular SCS"
1 Equal length"
1 SCS method"
21 Catchment 20"
10.000 % Impervious"
0.820 Total Area"
40.000 Flow length"
2.000 Overland Slope"
0.738 Pervious Area"
40.000 Pervious length"
2.000 Pervious slope"
0.082 Impervious Area"
40.000 Impervious length"
2.000 Impervious slope"
0.250 Pervious Manning 'n'"
74.000 Pervious SCS Curve No."
0.258 Pervious Runoff coefficient"
0.100 Pervious Ia/S coefficient"
8.924 Pervious Initial abstraction"
0.015 Impervious Manning 'n'"
98.000 Impervious SCS Curve No."
0.878 Impervious Runoff coefficient"
0.100 Impervious Ia/S coefficient"
0.518 Impervious Initial abstraction"
" 0.030 0.135 0.322 0.322 c.m/sec"
" Catchment 21 Pervious Impervious Total Area "
" Surface Area 0.738 0.082 0.820 hectare"
" Time of concentration 24.883 2.563 18.750 minutes"
" Time to Centroid 128.082 88.517 117.210 minutes"
" Rainfall depth 49.792 49.792 49.792 mm"
" Rainfall volume 367.46 40.83 408.29 c.m"
" Rainfall losses 36.970 6.066 33.879 mm"
" Runoff depth 12.822 43.726 15.913 mm"
" Runoff volume 94.63 35.86 130.48 c.m"
" Runoff coefficient 0.258 0.878 0.320 "
" Maximum flow 0.025 0.021 0.030 c.m/sec"
40 HYDROGRAPH Add Runoff "
4 Add Runoff "
" 0.030 0.152 0.322 0.322"
40 HYDROGRAPH Copy to Outflow"
8 Copy to Outflow"
" 0.030 0.152 0.152 0.322"
64 SHOW TABLE"
2 Flow hydrograph"
4 Inflow Hydrograph"
" Maximum flow 0.152 c.m/sec"

```

"			Existing__5yr		
"	40	Hydrograph volume	983.926	c.m"	
"		HYDROGRAPH Combine	1"		
"		6 Combine "			
"		1 Node #"			
"		Total"			
"		Maximum flow	0.472	c.m/sec"	
"		Hydrograph volume	2909.531	c.m"	
"		0.030 0.152	0.152	0.472"	
"	38	START/RE-START TOTALS 21"			
"		3 Runoff Totals on EXIT"			
"		Total Catchment area	22.700	hectare"	
"		Total Impervious area	0.082	hectare"	
"		Total % impervious	0.361"		
"	19	EXIT"			

```

Existing__10yr
"
"      MIDUSS Output ----->"
"      MIDUSS version                Version 2.25 rev. 473"
"      MIDUSS created                Sunday, February 07, 2010"
"      10  Units used:                ie METRIC"
"      Job folder:                   w:\Kitchener\411-2011\411009\Design Data\
"                                     Modelling Files\2019-02-15"
"      Output filename:              Existing__10yr.out"
"      Licensee name:                gmbp"
"      Company                       Hewlett-Packard Company"
"      Date & Time last used:       2/15/2019 at 2:03:37 PM"
" 31  TIME PARAMETERS"
"      5.000  Time Step"
"      180.000 Max. Storm length"
"      3600.000 Max. Hydrograph"
" 32  STORM Chicago storm"
"      1  Chicago storm"
"      2327.596 Coefficient A"
"      19.500  Constant B"
"      0.894  Exponent C"
"      0.380  Fraction R"
"      180.000 Duration"
"      1.000  Time step multiplier"
"      Maximum intensity             126.171  mm/hr"
"      Total depth                   61.359  mm"
"      6  010hyd Hydrograph extension used in this file"
" 33  CATCHMENT 30"
"      1  Triangular SCS"
"      1  Equal length"
"      1  SCS method"
"      30  Catchment 30"
"      0.000 % Impervious"
"      0.220 Total Area"
"      20.000 Flow length"
"      2.000 Overland slope"
"      0.220 Pervious Area"
"      20.000 Pervious length"
"      2.000 Pervious slope"
"      0.000 Impervious Area"
"      20.000 Impervious length"
"      2.000 Impervious slope"
"      0.250 Pervious Manning 'n'"
"      74.000 Pervious SCS Curve No."
"      0.316 Pervious Runoff coefficient"
"      0.100 Pervious Ia/S coefficient"
"      8.924 Pervious Initial abstraction"
"      0.015 Impervious Manning 'n'"
"      98.000 Impervious SCS Curve No."
"      0.000 Impervious Runoff coefficient"
"      0.100 Impervious Ia/S coefficient"
"      0.518 Impervious Initial abstraction"
"      0.015 0.000 0.000 0.000 c.m/sec"
"      Catchment 30 Pervious Impervious Total Area "
"      Surface Area 0.220 0.000 0.220 hectare"
"      Time of concentration 14.182 1.611 14.182 minutes"
"      Time to Centroid 113.894 86.563 113.893 minutes"
"      Rainfall depth 61.359 61.359 61.359 mm"
"      Rainfall volume 134.99 0.00 134.99 c.m"
"      Rainfall losses 41.992 6.044 41.992 mm"
"      Runoff depth 19.367 55.315 19.367 mm"
"      Runoff volume 42.61 0.00 42.61 c.m"
"      Runoff coefficient 0.316 0.000 0.316 "
"      Maximum flow 0.015 0.000 0.015 c.m/sec"
" 40  HYDROGRAPH Add Runoff "

```

```

Existing__10yr
"      4  Add Runoff "
"      0.015      0.015      0.000      0.000"
" 40  HYDROGRAPH Copy to Outflow"
"      8  Copy to Outflow"
"      0.015      0.015      0.015      0.000"
" 40  HYDROGRAPH Combine 2"
"      6  Combine "
"      2  Node #"
"      To Walser Street"
"      Maximum flow      0.015      c.m/sec"
"      Hydrograph volume      42.608      c.m"
"      0.015      0.015      0.015      0.015"
" 40  HYDROGRAPH Start - New Tributary"
"      2  Start - New Tributary"
"      0.015      0.000      0.015      0.015"
" 33  CATCHMENT 10"
"      1  Triangular SCS"
"      1  Equal length"
"      1  SCS method"
"      10  Catchment 10"
"      0.000  % Impervious"
"      7.760  Total Area"
"      150.000  Flow length"
"      2.000  Overland Slope"
"      7.760  Pervious Area"
"      150.000  Pervious length"
"      2.000  Pervious slope"
"      0.000  Impervious Area"
"      150.000  Impervious length"
"      2.000  Impervious slope"
"      0.250  Pervious Manning 'n'"
"      74.000  Pervious SCS Curve No."
"      0.316  Pervious Runoff coefficient"
"      0.100  Pervious Ia/S coefficient"
"      8.924  Pervious Initial abstraction"
"      0.015  Impervious Manning 'n'"
"      98.000  Impervious SCS Curve No."
"      0.000  Impervious Runoff coefficient"
"      0.100  Impervious Ia/S coefficient"
"      0.518  Impervious Initial abstraction"
"      0.273      0.000      0.015      0.015 c.m/sec"
"      Catchment 10      Pervious      Impervious      Total Area "
"      Surface Area      7.760      0.000      7.760      hectare"
"      Time of concentration      47.507      5.395      47.507      minutes"
"      Time to Centroid      151.963      91.698      151.963      minutes"
"      Rainfall depth      61.359      61.359      61.359      mm"
"      Rainfall volume      4761.47      0.00      4761.48      c.m"
"      Rainfall losses      41.963      5.633      41.963      mm"
"      Runoff depth      19.396      55.726      19.396      mm"
"      Runoff volume      1505.11      0.00      1505.12      c.m"
"      Runoff coefficient      0.316      0.000      0.316      "
"      Maximum flow      0.273      0.000      0.273      c.m/sec"
" 40  HYDROGRAPH Add Runoff "
"      4  Add Runoff "
"      0.273      0.273      0.015      0.015"
" 33  CATCHMENT 11"
"      1  Triangular SCS"
"      1  Equal length"
"      1  SCS method"
"      11  Catchment 11"
"      0.000  % Impervious"
"      0.130  Total Area"
"      40.000  Flow length"

```

Existing__10yr

"	2.000	Overland Slope"				
"	0.130	Pervious Area"				
"	40.000	Pervious length"				
"	2.000	Pervious slope"				
"	0.000	Impervious Area"				
"	40.000	Impervious length"				
"	2.000	Impervious slope"				
"	0.250	Pervious Manning 'n'"				
"	74.000	Pervious SCS Curve No."				
"	0.316	Pervious Runoff coefficient"				
"	0.100	Pervious Ia/S coefficient"				
"	8.924	Pervious Initial abstraction"				
"	0.015	Impervious Manning 'n'"				
"	98.000	Impervious SCS Curve No."				
"	0.000	Impervious Runoff coefficient"				
"	0.100	Impervious Ia/S coefficient"				
"	0.518	Impervious Initial abstraction"				
"		0.008	0.273	0.015	0.015 c.m/sec"	
"		Catchment 11	Pervious	Impervious	Total Area	"
"		Surface Area	0.130	0.000	0.130	hectare"
"		Time of concentration	21.495	2.441	21.495	minutes"
"		Time to Centroid	122.241	87.742	122.240	minutes"
"		Rainfall depth	61.359	61.359	61.359	mm"
"		Rainfall volume	79.77	0.00	79.77	c.m"
"		Rainfall losses	41.967	6.310	41.967	mm"
"		Runoff depth	19.392	55.050	19.393	mm"
"		Runoff volume	25.21	0.00	25.21	c.m"
"		Runoff coefficient	0.316	0.000	0.316	"
"		Maximum flow	0.008	0.000	0.008	c.m/sec"
" 40		HYDROGRAPH Add Runoff "				
"	4	Add Runoff "				
"		0.008	0.277	0.015	0.015"	
" 33		CATCHMENT 40"				
"	1	Triangular SCS"				
"	1	Equal length"				
"	1	SCS method"				
"	40	Catchment 40"				
"	0.000	% Impervious"				
"	7.120	Total Area"				
"	60.000	Flow length"				
"	2.000	Overland Slope"				
"	7.120	Pervious Area"				
"	60.000	Pervious length"				
"	2.000	Pervious slope"				
"	0.000	Impervious Area"				
"	60.000	Impervious length"				
"	2.000	Impervious slope"				
"	0.250	Pervious Manning 'n'"				
"	74.000	Pervious SCS Curve No."				
"	0.316	Pervious Runoff coefficient"				
"	0.100	Pervious Ia/S coefficient"				
"	8.924	Pervious Initial abstraction"				
"	0.015	Impervious Manning 'n'"				
"	98.000	Impervious SCS Curve No."				
"	0.000	Impervious Runoff coefficient"				
"	0.100	Impervious Ia/S coefficient"				
"	0.518	Impervious Initial abstraction"				
"		0.359	0.277	0.015	0.015 c.m/sec"	
"		Catchment 40	Pervious	Impervious	Total Area	"
"		Surface Area	7.120	0.000	7.120	hectare"
"		Time of concentration	27.416	3.114	27.416	minutes"
"		Time to Centroid	128.990	88.727	128.990	minutes"
"		Rainfall depth	61.359	61.359	61.359	mm"

```

Existing_10yr
"      Rainfall volume      4368.77      0.00      4368.78      c.m"
"      Rainfall losses      41.968      6.469      41.968      mm"
"      Runoff depth         19.392      54.890      19.392      mm"
"      Runoff volume         1380.67     0.00      1380.68     c.m"
"      Runoff coefficient    0.316      0.000      0.316      "
"      Maximum flow         0.359      0.000      0.359      c.m/sec"
40    HYDROGRAPH Add Runoff "
"      4 Add Runoff "
"      0.359      0.608      0.015      0.015"
54    POND DESIGN"
"      0.608 Current peak flow c.m/sec"
"      0.050 Target outflow c.m/sec"
"      2911.0 Hydrograph volume c.m"
"      6 Number of stages"
"      409.630 Minimum water level metre"
"      410.750 Maximum water level metre"
"      409.630 Starting water level metre"
"      0 Keep Design Data: 1 = True; 0 = False"
"      Level Discharge Volume"
"      409.630 0.000 0.000"
"      409.750 0.6650 402.200"
"      410.000 3.601 2187.900"
"      410.250 7.811 5318.900"
"      410.500 12.984 9642.300"
"      410.750 18.965 15227.70"
"      Peak outflow 0.549 c.m/sec"
"      Maximum level 409.729 metre"
"      Maximum storage 332.166 c.m"
"      Centroidal lag 2.515 hours"
"      0.359 0.608 0.549 0.015 c.m/sec"
40    HYDROGRAPH Next link "
"      5 Next link "
"      0.359 0.549 0.549 0.015"
52    CHANNEL DESIGN"
"      0.549 Current peak flow c.m/sec"
"      0.035 Manning 'n'"
"      0 Cross-section type: 0=trapezoidal; 1=general"
"      0.000 Basewidth metre"
"      7.410 Left bank slope"
"      6.000 Right bank slope"
"      0.950 Channel depth metre"
"      1.040 Gradient %"
"      Depth of flow 0.312 metre"
"      Velocity 0.839 m/sec"
"      Channel capacity 10.655 c.m/sec"
"      Critical depth 0.267 metre"
53    ROUTE Channel Route 72"
"      72.40 Channel Route 72 Reach length (metre)"
"      0.422 X-factor <= 0.5"
"      64.729 K-lag (seconds)"
"      0.000 Default(0) or user spec.(1) values used"
"      0.500 X-factor <= 0.5"
"      30.000 K-lag (seconds)"
"      0.500 Beta weighting factor"
"      60.000 Routing time step (seconds)"
"      1 No. of sub-reaches"
"      Peak outflow 0.547 c.m/sec"
"      0.359 0.549 0.547 0.015 c.m/sec"
40    HYDROGRAPH Next link "
"      5 Next link "
"      0.359 0.547 0.547 0.015"
52    CHANNEL DESIGN"
"      0.547 Current peak flow c.m/sec"

```

Existing__10yr

```

"      0.035 Manning 'n'"
"      0.      Cross-section type: 0=trapezoidal; 1=general"
"      2.000 Basewidth      metre"
"      2.950 Left bank slope"
"      3.000 Right bank slope"
"      0.950 Channel depth      metre"
"      1.040 Gradient      %"
"      Depth of flow      0.224      metre"
"      Velocity      0.914      m/sec"
"      Channel capacity      9.246      c.m/sec"
"      Critical depth      0.179      metre"
53  ROUTE      Channel Route 40"
"      39.80      Channel Route 40 Reach length      ( metre)"
"      0.350 X-factor <= 0.5"
"      32.667 K-lag      ( seconds)"
"      0.000 Default(0) or user spec.(1) values used"
"      0.500 X-factor <= 0.5"
"      30.000 K-lag      ( seconds)"
"      0.500 Beta weighting factor"
"      37.500 Routing time step      ( seconds)"
"      1 No. of sub-reaches"
"      Peak outflow      0.546      c.m/sec"
"      0.359      0.547      0.546      0.015 c.m/sec"
40  HYDROGRAPH Next link "
"      5 Next link "
"      0.359      0.546      0.546      0.015"
40  HYDROGRAPH Copy to Outflow"
"      8 Copy to Outflow"
"      0.359      0.546      0.546      0.015"
40  HYDROGRAPH Combine 1"
"      6 Combine "
"      1 Node #"
"      Total"
"      Maximum flow      0.546      c.m/sec"
"      Hydrograph volume      2911.006      c.m"
"      0.359      0.546      0.546      0.546"
40  HYDROGRAPH Start - New Tributary"
"      2 Start - New Tributary"
"      0.359      0.000      0.546      0.546"
33  CATCHMENT 20"
"      1 Triangular SCS"
"      1 Equal length"
"      1 SCS method"
"      20 Catchment 20"
"      0.000 % Impervious"
"      6.650 Total Area"
"      150.000 Flow length"
"      2.000 Overland Slope"
"      6.650 Pervious Area"
"      150.000 Pervious length"
"      2.000 Pervious slope"
"      0.000 Impervious Area"
"      150.000 Impervious length"
"      2.000 Impervious slope"
"      0.250 Pervious Manning 'n'"
"      74.000 Pervious SCS Curve No."
"      0.316 Pervious Runoff coefficient"
"      0.100 Pervious Ia/S coefficient"
"      8.924 Pervious Initial abstraction"
"      0.015 Impervious Manning 'n'"
"      98.000 Impervious SCS Curve No."
"      0.000 Impervious Runoff coefficient"
"      0.100 Impervious Ia/S coefficient"

```

Existing_10yr					
0.518	Impervious Initial abstraction"				
	0.234	0.000	0.546	0.546	c.m/sec"
	Catchment 20	Pervious	Impervious	Total Area	"
	Surface Area	6.650	0.000	6.650	hectare"
	Time of concentration	47.507	5.395	47.507	minutes"
	Time to Centroid	151.963	91.698	151.963	minutes"
	Rainfall depth	61.359	61.359	61.359	mm"
	Rainfall volume	4080.39	0.00	4080.39	c.m"
	Rainfall losses	41.963	5.633	41.963	mm"
	Runoff depth	19.396	55.726	19.396	mm"
	Runoff volume	1289.82	0.00	1289.82	c.m"
	Runoff coefficient	0.316	0.000	0.316	"
	Maximum flow	0.234	0.000	0.234	c.m/sec"
40	HYDROGRAPH Add Runoff "				
	4 Add Runoff "				
	0.234	0.234	0.546	0.546"	
33	CATCHMENT 21"				
	1 Triangular SCS"				
	1 Equal length"				
	1 SCS method"				
	21 Catchment 20"				
	10.000 % Impervious"				
	0.820 Total Area"				
	40.000 Flow length"				
	2.000 Overland Slope"				
	0.738 Pervious Area"				
	40.000 Pervious length"				
	2.000 Pervious slope"				
	0.082 Impervious Area"				
	40.000 Impervious length"				
	2.000 Impervious slope"				
	0.250 Pervious Manning 'n'"				
	74.000 Pervious SCS Curve No."				
	0.316 Pervious Runoff coefficient"				
	0.100 Pervious Ia/S coefficient"				
	8.924 Pervious Initial abstraction"				
	0.015 Impervious Manning 'n'"				
	98.000 Impervious SCS Curve No."				
	0.897 Impervious Runoff coefficient"				
	0.100 Impervious Ia/S coefficient"				
	0.518 Impervious Initial abstraction"				
	0.049	0.234	0.546	0.546	c.m/sec"
	Catchment 21	Pervious	Impervious	Total Area	"
	Surface Area	0.738	0.082	0.820	hectare"
	Time of concentration	21.495	2.441	16.926	minutes"
	Time to Centroid	122.241	87.742	113.968	minutes"
	Rainfall depth	61.359	61.359	61.359	mm"
	Rainfall volume	452.83	50.31	503.15	c.m"
	Rainfall losses	41.967	6.310	38.401	mm"
	Runoff depth	19.392	55.050	22.958	mm"
	Runoff volume	143.12	45.14	188.26	c.m"
	Runoff coefficient	0.316	0.897	0.374	"
	Maximum flow	0.043	0.024	0.049	c.m/sec"
40	HYDROGRAPH Add Runoff "				
	4 Add Runoff "				
	0.049	0.263	0.546	0.546"	
40	HYDROGRAPH Copy to Outflow"				
	8 Copy to Outflow"				
	0.049	0.263	0.263	0.546"	
64	SHOW TABLE"				
	2 Flow hydrograph"				
	4 Inflow Hydrograph"				
	Maximum flow		0.263	c.m/sec"	

"			Existing_10yr		
"	40	Hydrograph volume	1478.082		c.m"
"		HYDROGRAPH	Combine	1"	
"		6	Combine	"	
"		1	Node #"		
"			Total"		
"		Maximum flow	0.806		c.m/sec"
"		Hydrograph volume	4389.088		c.m"
"			0.049	0.263	
"	38		0.263	0.806"	
"		START/RE-START TOTALS	21"		
"		3	Runoff Totals on EXIT"		
"		Total Catchment area		22.700	hectare"
"		Total Impervious area		0.082	hectare"
"		Total % impervious		0.361"	
"	19	EXIT"			

```

Existing__25yr
"
"      MIDUSS Output ----->"
"      MIDUSS version                Version 2.25 rev. 473"
"      MIDUSS created                Sunday, February 07, 2010"
"      10 Units used:                  ie METRIC"
"      Job folder:                    w:\Kitchener\411-2011\411009\Design Data\
"                                      Modelling Files\2019-02-15"
"      Output filename:              Existing__25yr.out"
"      Licensee name:                gmbp"
"      Company                        Hewlett-Packard Company"
"      Date & Time last used:        2/15/2019 at 2:06:47 PM"
" 31      TIME PARAMETERS"
"      5.000 Time Step"
"      180.000 Max. Storm length"
"      3600.000 Max. Hydrograph"
" 32      STORM Chicago storm"
"      1 Chicago storm"
"      3701.648 Coefficient A"
"      25.500 Constant B"
"      0.937 Exponent C"
"      0.380 Fraction R"
"      180.000 Duration"
"      1.000 Time step multiplier"
"      Maximum intensity              143.371 mm/hr"
"      Total depth                    75.581 mm"
"      6 025hyd Hydrograph extension used in this file"
" 33      CATCHMENT 30"
"      1 Triangular SCS"
"      1 Equal length"
"      1 SCS method"
"      30 Catchment 30"
"      0.000 % Impervious"
"      0.220 Total Area"
"      20.000 Flow length"
"      2.000 Overland slope"
"      0.220 Pervious Area"
"      20.000 Pervious length"
"      2.000 Pervious slope"
"      0.000 Impervious Area"
"      20.000 Impervious length"
"      2.000 Impervious slope"
"      0.250 Pervious Manning 'n'"
"      74.000 Pervious SCS Curve No."
"      0.376 Pervious Runoff coefficient"
"      0.100 Pervious Ia/S coefficient"
"      8.924 Pervious Initial abstraction"
"      0.015 Impervious Manning 'n'"
"      98.000 Impervious SCS Curve No."
"      0.000 Impervious Runoff coefficient"
"      0.100 Impervious Ia/S coefficient"
"      0.518 Impervious Initial abstraction"
"      0.024 0.000 0.000 0.000 c.m/sec"
"      Catchment 30 Pervious Impervious Total Area "
"      Surface Area 0.220 0.000 0.220 hectare"
"      Time of concentration 12.370 1.523 12.370 minutes"
"      Time to Centroid 110.314 85.984 110.314 minutes"
"      Rainfall depth 75.581 75.581 75.581 mm"
"      Rainfall volume 166.28 0.00 166.28 c.m"
"      Rainfall losses 47.190 6.330 47.190 mm"
"      Runoff depth 28.391 69.250 28.391 mm"
"      Runoff volume 62.46 0.00 62.46 c.m"
"      Runoff coefficient 0.376 0.000 0.376 "
"      Maximum flow 0.024 0.000 0.024 c.m/sec"
" 40      HYDROGRAPH Add Runoff "

```

```

Existing__25yr
"      4  Add Runoff "
"      0.024  0.024  0.000  0.000"
" 40  HYDROGRAPH Copy to Outflow"
"      8  Copy to Outflow"
"      0.024  0.024  0.024  0.000"
" 40  HYDROGRAPH Combine 2"
"      6  Combine "
"      2  Node #"
"      To Walser Street"
"      Maximum flow 0.024 c.m/sec"
"      Hydrograph volume 62.461 c.m"
"      0.024  0.024  0.024  0.024"
" 40  HYDROGRAPH Start - New Tributary"
"      2  Start - New Tributary"
"      0.024  0.000  0.024  0.024"
" 33  CATCHMENT 10"
"      1  Triangular SCS"
"      1  Equal length"
"      1  SCS method"
"      10  Catchment 10"
"      0.000  % Impervious"
"      7.760  Total Area"
"      150.000  Flow length"
"      2.000  Overland Slope"
"      7.760  Pervious Area"
"      150.000  Pervious length"
"      2.000  Pervious slope"
"      0.000  Impervious Area"
"      150.000  Impervious length"
"      2.000  Impervious slope"
"      0.250  Pervious Manning 'n'"
"      74.000  Pervious SCS Curve No."
"      0.377  Pervious Runoff coefficient"
"      0.100  Pervious Ia/S coefficient"
"      8.924  Pervious Initial abstraction"
"      0.015  Impervious Manning 'n'"
"      98.000  Impervious SCS Curve No."
"      0.000  Impervious Runoff coefficient"
"      0.100  Impervious Ia/S coefficient"
"      0.518  Impervious Initial abstraction"
"      0.454  0.000  0.024  0.024 c.m/sec"
"      Catchment 10 Pervious Impervious Total Area "
"      Surface Area 7.760 0.000 7.760 hectare"
"      Time of concentration 41.437 5.102 41.437 minutes"
"      Time to Centroid 143.191 90.751 143.190 minutes"
"      Rainfall depth 75.581 75.581 75.581 mm"
"      Rainfall volume 5865.07 0.01 5865.07 c.m"
"      Rainfall losses 47.093 5.908 47.093 mm"
"      Runoff depth 28.488 69.673 28.488 mm"
"      Runoff volume 2210.64 0.01 2210.65 c.m"
"      Runoff coefficient 0.377 0.000 0.377 "
"      Maximum flow 0.454 0.000 0.454 c.m/sec"
" 40  HYDROGRAPH Add Runoff "
"      4  Add Runoff "
"      0.454  0.454  0.024  0.024"
" 33  CATCHMENT 11"
"      1  Triangular SCS"
"      1  Equal length"
"      1  SCS method"
"      11  Catchment 11"
"      0.000  % Impervious"
"      0.130  Total Area"
"      40.000  Flow length"

```

Existing__25yr

"	2.000	Overland Slope"				
"	0.130	Pervious Area"				
"	40.000	Pervious length"				
"	2.000	Pervious slope"				
"	0.000	Impervious Area"				
"	40.000	Impervious length"				
"	2.000	Impervious slope"				
"	0.250	Pervious Manning 'n'"				
"	74.000	Pervious SCS Curve No."				
"	0.376	Pervious Runoff coefficient"				
"	0.100	Pervious Ia/S coefficient"				
"	8.924	Pervious Initial abstraction"				
"	0.015	Impervious Manning 'n'"				
"	98.000	Impervious SCS Curve No."				
"	0.000	Impervious Runoff coefficient"				
"	0.100	Impervious Ia/S coefficient"				
"	0.518	Impervious Initial abstraction"				
"		0.012	0.454	0.024	0.024 c.m/sec"	
"		Catchment 11	Pervious	Impervious	Total Area	"
"		Surface Area	0.130	0.000	0.130	hectare"
"		Time of concentration	18.749	2.308	18.749	minutes"
"		Time to Centroid	117.510	87.059	117.510	minutes"
"		Rainfall depth	75.581	75.581	75.581	mm"
"		Rainfall volume	98.25	0.00	98.26	c.m"
"		Rainfall losses	47.127	6.593	47.127	mm"
"		Runoff depth	28.453	68.988	28.453	mm"
"		Runoff volume	36.99	0.00	36.99	c.m"
"		Runoff coefficient	0.376	0.000	0.376	"
"		Maximum flow	0.012	0.000	0.012	c.m/sec"
" 40		HYDROGRAPH Add Runoff "				
"	4	Add Runoff "				
"		0.012	0.461	0.024	0.024"	
" 33		CATCHMENT 40"				
"	1	Triangular SCS"				
"	1	Equal length"				
"	1	SCS method"				
"	40	Catchment 40"				
"	0.000	% Impervious"				
"	7.120	Total Area"				
"	60.000	Flow length"				
"	2.000	Overland Slope"				
"	7.120	Pervious Area"				
"	60.000	Pervious length"				
"	2.000	Pervious slope"				
"	0.000	Impervious Area"				
"	60.000	Impervious length"				
"	2.000	Impervious slope"				
"	0.250	Pervious Manning 'n'"				
"	74.000	Pervious SCS Curve No."				
"	0.377	Pervious Runoff coefficient"				
"	0.100	Pervious Ia/S coefficient"				
"	8.924	Pervious Initial abstraction"				
"	0.015	Impervious Manning 'n'"				
"	98.000	Impervious SCS Curve No."				
"	0.000	Impervious Runoff coefficient"				
"	0.100	Impervious Ia/S coefficient"				
"	0.518	Impervious Initial abstraction"				
"		0.584	0.461	0.024	0.024 c.m/sec"	
"		Catchment 40	Pervious	Impervious	Total Area	"
"		Surface Area	7.120	0.000	7.120	hectare"
"		Time of concentration	23.913	2.944	23.913	minutes"
"		Time to Centroid	123.357	87.974	123.357	minutes"
"		Rainfall depth	75.581	75.581	75.581	mm"

```

Existing__25yr
" Rainfall volume 5381.35 0.01 5381.36 c.m"
" Rainfall losses 47.108 6.942 47.107 mm"
" Runoff depth 28.473 68.639 28.473 mm"
" Runoff volume 2027.30 0.00 2027.30 c.m"
" Runoff coefficient 0.377 0.000 0.377 "
" Maximum flow 0.584 0.000 0.584 c.m/sec"
40 HYDROGRAPH Add Runoff "
" 4 Add Runoff "
" 0.584 1.001 0.024 0.024"
54 POND DESIGN"
" 1.001 Current peak flow c.m/sec"
" 0.050 Target outflow c.m/sec"
" 4274.9 Hydrograph volume c.m"
" 6. Number of stages"
" 409.630 Minimum water level metre"
" 410.750 Maximum water level metre"
" 409.630 Starting water level metre"
" 0 Keep Design Data: 1 = True; 0 = False"
" Level Discharge Volume"
" 409.630 0.000 0.000"
" 409.750 0.6650 402.200"
" 410.000 3.601 2187.900"
" 410.250 7.811 5318.900"
" 410.500 12.984 9642.300"
" 410.750 18.965 15227.70"
" Peak outflow 0.886 c.m/sec"
" Maximum level 409.769 metre"
" Maximum storage 536.694 c.m"
" Centroidal lag 2.394 hours"
" 0.584 1.001 0.886 0.024 c.m/sec"
40 HYDROGRAPH Next link "
" 5 Next link "
" 0.584 0.886 0.886 0.024"
52 CHANNEL DESIGN"
" 0.886 Current peak flow c.m/sec"
" 0.035 Manning 'n'"
" 0. Cross-section type: 0=trapezoidal; 1=general"
" 0.000 Basewidth metre"
" 7.410 Left bank slope"
" 6.000 Right bank slope"
" 0.950 Channel depth metre"
" 1.040 Gradient %"
" Depth of flow 0.374 metre"
" Velocity 0.946 m/sec"
" Channel capacity 10.655 c.m/sec"
" Critical depth 0.324 metre"
53 ROUTE Channel Route 72"
" 72.40 Channel Route 72 Reach length (metre)"
" 0.407 X-factor <= 0.5"
" 57.429 K-lag (seconds)"
" 0.000 Default(0) or user spec.(1) values used"
" 0.500 X-factor <= 0.5"
" 30.000 K-lag (seconds)"
" 0.500 Beta weighting factor"
" 60.000 Routing time step (seconds)"
" 1 No. of sub-reaches"
" Peak outflow 0.880 c.m/sec"
" 0.584 0.886 0.880 0.024 c.m/sec"
40 HYDROGRAPH Next link "
" 5 Next link "
" 0.584 0.880 0.880 0.024"
52 CHANNEL DESIGN"
" 0.880 Current peak flow c.m/sec"

```

Existing__25yr

```

"      0.035 Manning 'n'"
"      0.      Cross-section type: 0=trapezoidal; 1=general"
"      2.000 Basewidth      metre"
"      2.950 Left bank slope"
"      3.000 Right bank slope"
"      0.950 Channel depth      metre"
"      1.040 Gradient      %"
"      Depth of flow      0.291      metre"
"      Velocity      1.055      m/sec"
"      Channel capacity      9.246      c.m/sec"
"      Critical depth      0.239      metre"
53  ROUTE      Channel Route 40"
"      39.80      Channel Route 40 Reach length      ( metre)"
"      0.310 X-factor <= 0.5"
"      28.289 K-lag      ( seconds)"
"      0.000 Default(0) or user spec.(1) values used"
"      0.500 X-factor <= 0.5"
"      30.000 K-lag      ( seconds)"
"      0.500 Beta weighting factor"
"      37.500 Routing time step      ( seconds)"
"      1 No. of sub-reaches"
"      Peak outflow      0.877      c.m/sec"
"      0.584      0.880      0.877      0.024 c.m/sec"
40  HYDROGRAPH Next link "
"      5 Next link "
"      0.584      0.877      0.877      0.024"
40  HYDROGRAPH Copy to Outflow"
"      8 Copy to Outflow"
"      0.584      0.877      0.877      0.024"
40  HYDROGRAPH Combine 1"
"      6 Combine "
"      1 Node #"
"      Total"
"      Maximum flow      0.877      c.m/sec"
"      Hydrograph volume      4274.952      c.m"
"      0.584      0.877      0.877      0.877"
40  HYDROGRAPH Start - New Tributary"
"      2 Start - New Tributary"
"      0.584      0.000      0.877      0.877"
33  CATCHMENT 20"
"      1 Triangular SCS"
"      1 Equal length"
"      1 SCS method"
"      20 Catchment 20"
"      0.000 % Impervious"
"      6.650 Total Area"
"      150.000 Flow length"
"      2.000 Overland Slope"
"      6.650 Pervious Area"
"      150.000 Pervious length"
"      2.000 Pervious slope"
"      0.000 Impervious Area"
"      150.000 Impervious length"
"      2.000 Impervious slope"
"      0.250 Pervious Manning 'n'"
"      74.000 Pervious SCS Curve No."
"      0.377 Pervious Runoff coefficient"
"      0.100 Pervious Ia/S coefficient"
"      8.924 Pervious Initial abstraction"
"      0.015 Impervious Manning 'n'"
"      98.000 Impervious SCS Curve No."
"      0.000 Impervious Runoff coefficient"
"      0.100 Impervious Ia/S coefficient"

```

```

Existing_25yr
" 0.518 Impervious Initial abstraction"
" 0.389 0.000 0.877 0.877 c.m/sec"
" Catchment 20 Pervious Impervious Total Area "
" Surface Area 6.650 0.000 6.650 hectare"
" Time of concentration 41.437 5.102 41.437 minutes"
" Time to Centroid 143.191 90.751 143.190 minutes"
" Rainfall depth 75.581 75.581 75.581 mm"
" Rainfall volume 5026.12 0.01 5026.13 c.m"
" Rainfall losses 47.093 5.908 47.093 mm"
" Runoff depth 28.488 69.673 28.488 mm"
" Runoff volume 1894.43 0.00 1894.44 c.m"
" Runoff coefficient 0.377 0.000 0.377 "
" Maximum flow 0.389 0.000 0.389 c.m/sec"
40 HYDROGRAPH Add Runoff "
4 Add Runoff "
" 0.389 0.389 0.877 0.877"
33 CATCHMENT 21"
1 Triangular SCS"
1 Equal length"
1 SCS method"
21 Catchment 20"
10.000 % Impervious"
0.820 Total Area"
40.000 Flow length"
2.000 Overland Slope"
0.738 Pervious Area"
40.000 Pervious length"
2.000 Pervious slope"
0.082 Impervious Area"
40.000 Impervious length"
2.000 Impervious slope"
0.250 Pervious Manning 'n'"
74.000 Pervious SCS Curve No."
0.376 Pervious Runoff coefficient"
0.100 Pervious Ia/S coefficient"
8.924 Pervious Initial abstraction"
0.015 Impervious Manning 'n'"
98.000 Impervious SCS Curve No."
0.913 Impervious Runoff coefficient"
0.100 Impervious Ia/S coefficient"
0.518 Impervious Initial abstraction"
" 0.078 0.389 0.877 0.877 c.m/sec"
" Catchment 21 Pervious Impervious Total Area "
" Surface Area 0.738 0.082 0.820 hectare"
" Time of concentration 18.749 2.308 15.260 minutes"
" Time to Centroid 117.510 87.059 111.048 minutes"
" Rainfall depth 75.581 75.581 75.581 mm"
" Rainfall volume 557.79 61.98 619.76 c.m"
" Rainfall losses 47.127 6.593 43.074 mm"
" Runoff depth 28.453 68.988 32.507 mm"
" Runoff volume 209.99 56.57 266.56 c.m"
" Runoff coefficient 0.376 0.913 0.430 "
" Maximum flow 0.068 0.028 0.078 c.m/sec"
40 HYDROGRAPH Add Runoff "
4 Add Runoff "
" 0.078 0.435 0.877 0.877"
40 HYDROGRAPH Copy to Outflow"
8 Copy to Outflow"
" 0.078 0.435 0.435 0.877"
64 SHOW TABLE"
2 Flow hydrograph"
4 Inflow Hydrograph"
" Maximum flow 0.435 c.m/sec"

```

"			Existing_25yr		
"	40	Hydrograph volume	2160.991		c.m"
"		HYDROGRAPH Combine	1"		
"		6 Combine "			
"		1 Node #"			
"		Total"			
"		Maximum flow	1.308		c.m/sec"
"		Hydrograph volume	6435.943		c.m"
"		0.078 0.435	0.435		1.308"
"	38	START/RE-START TOTALS 21"			
"		3 Runoff Totals on EXIT"			
"		Total Catchment area		22.700	hectare"
"		Total Impervious area		0.082	hectare"
"		Total % impervious		0.361"	
"	19	EXIT"			

```

Existing__50yr
"
" MIDUSS Output ----->"
" MIDUSS version Version 2.25 rev. 473"
" MIDUSS created Sunday, February 07, 2010"
" 10 Units used: ie METRIC"
" Job folder: w:\Kitchener\411-2011\411009\Design Data\
" Modelling Files\2019-02-15"
" Output filename: Existing__50yr.out"
" Licensee name: gmbp"
" Company Hewlett-Packard Company"
" Date & Time last used: 2/15/2019 at 2:17:43 PM"
" 31 TIME PARAMETERS"
" 5.000 Time Step"
" 180.000 Max. Storm length"
" 3600.000 Max. Hydrograph"
" 32 STORM Chicago storm"
" 1 Chicago storm"
" 5089.420 Coefficient A"
" 30.000 Constant B"
" 0.967 Exponent C"
" 0.380 Fraction R"
" 180.000 Duration"
" 1.000 Time step multiplier"
" Maximum intensity 156.350 mm/hr"
" Total depth 86.737 mm"
" 6 050hyd Hydrograph extension used in this file"
" 33 CATCHMENT 30"
" 1 Triangular SCS"
" 1 Equal length"
" 1 SCS method"
" 30 Catchment 30"
" 0.000 % Impervious"
" 0.220 Total Area"
" 20.000 Flow length"
" 2.000 Overland slope"
" 0.220 Pervious Area"
" 20.000 Pervious length"
" 2.000 Pervious slope"
" 0.000 Impervious Area"
" 20.000 Impervious length"
" 2.000 Impervious slope"
" 0.250 Pervious Manning 'n'"
" 74.000 Pervious SCS Curve No."
" 0.417 Pervious Runoff coefficient"
" 0.100 Pervious Ia/S coefficient"
" 8.924 Pervious Initial abstraction"
" 0.015 Impervious Manning 'n'"
" 98.000 Impervious SCS Curve No."
" 0.000 Impervious Runoff coefficient"
" 0.100 Impervious Ia/S coefficient"
" 0.518 Impervious Initial abstraction"
" 0.032 0.000 0.000 0.000 c.m/sec"
" Catchment 30 Pervious Impervious Total Area "
" Surface Area 0.220 0.000 0.220 hectare"
" Time of concentration 11.375 1.467 11.375 minutes"
" Time to Centroid 108.305 85.675 108.305 minutes"
" Rainfall depth 86.737 86.737 86.737 mm"
" Rainfall volume 190.82 0.00 190.82 c.m"
" Rainfall losses 50.570 6.561 50.570 mm"
" Runoff depth 36.167 80.176 36.167 mm"
" Runoff volume 79.57 0.00 79.57 c.m"
" Runoff coefficient 0.417 0.000 0.417 "
" Maximum flow 0.032 0.000 0.032 c.m/sec"
" 40 HYDROGRAPH Add Runoff "

```

```

Existing__50yr
"      4  Add Runoff "
"      0.032  0.032  0.000  0.000"
" 40  HYDROGRAPH Copy to Outflow"
"      8  Copy to Outflow"
"      0.032  0.032  0.032  0.000"
" 40  HYDROGRAPH Combine 2"
"      6  Combine "
"      2  Node #"
"      To Walser Street"
"      Maximum flow 0.032 c.m/sec"
"      Hydrograph volume 79.567 c.m"
"      0.032  0.032  0.032  0.032"
" 40  HYDROGRAPH Start - New Tributary"
"      2  Start - New Tributary"
"      0.032  0.000  0.032  0.032"
" 33  CATCHMENT 10"
"      1  Triangular SCS"
"      1  Equal length"
"      1  SCS method"
"      10  Catchment 10"
"      0.000  % Impervious"
"      7.760  Total Area"
"      150.000  Flow length"
"      2.000  Overland Slope"
"      7.760  Pervious Area"
"      150.000  Pervious length"
"      2.000  Pervious slope"
"      0.000  Impervious Area"
"      150.000  Impervious length"
"      2.000  Impervious slope"
"      0.250  Pervious Manning 'n'"
"      74.000  Pervious SCS Curve No."
"      0.418  Pervious Runoff coefficient"
"      0.100  Pervious Ia/S coefficient"
"      8.924  Pervious Initial abstraction"
"      0.015  Impervious Manning 'n'"
"      98.000  Impervious SCS Curve No."
"      0.000  Impervious Runoff coefficient"
"      0.100  Impervious Ia/S coefficient"
"      0.518  Impervious Initial abstraction"
"      0.618  0.000  0.032  0.032 c.m/sec"
"      Catchment 10 Pervious Impervious Total Area "
"      Surface Area 7.760 0.000 7.760 hectare"
"      Time of concentration 38.106 4.916 38.106 minutes"
"      Time to Centroid 138.366 90.175 138.366 minutes"
"      Rainfall depth 86.737 86.737 86.737 mm"
"      Rainfall volume 6730.77 0.01 6730.78 c.m"
"      Rainfall losses 50.510 5.941 50.510 mm"
"      Runoff depth 36.227 80.796 36.227 mm"
"      Runoff volume 2811.21 0.01 2811.22 c.m"
"      Runoff coefficient 0.418 0.000 0.418 "
"      Maximum flow 0.618 0.000 0.618 c.m/sec"
" 40  HYDROGRAPH Add Runoff "
"      4  Add Runoff "
"      0.618  0.618  0.032  0.032"
" 33  CATCHMENT 11"
"      1  Triangular SCS"
"      1  Equal length"
"      1  SCS method"
"      11  Catchment 11"
"      0.000  % Impervious"
"      0.130  Total Area"
"      40.000  Flow length"

```

Existing__50yr

"	2.000	Overland Slope"				
"	0.130	Pervious Area"				
"	40.000	Pervious length"				
"	2.000	Pervious slope"				
"	0.000	Impervious Area"				
"	40.000	Impervious length"				
"	2.000	Impervious slope"				
"	0.250	Pervious Manning 'n'"				
"	74.000	Pervious SCS Curve No."				
"	0.417	Pervious Runoff coefficient"				
"	0.100	Pervious Ia/S coefficient"				
"	8.924	Pervious Initial abstraction"				
"	0.015	Impervious Manning 'n'"				
"	98.000	Impervious SCS Curve No."				
"	0.000	Impervious Runoff coefficient"				
"	0.100	Impervious Ia/S coefficient"				
"	0.518	Impervious Initial abstraction"				
"		0.016	0.618	0.032	0.032 c.m/sec"	
"		Catchment 11	Pervious	Impervious	Total Area	"
"		Surface Area	0.130	0.000	0.130	hectare"
"		Time of concentration	17.241	2.224	17.241	minutes"
"		Time to Centroid	114.897	86.667	114.896	minutes"
"		Rainfall depth	86.737	86.737	86.737	mm"
"		Rainfall volume	112.76	0.00	112.76	c.m"
"		Rainfall losses	50.540	6.773	50.540	mm"
"		Runoff depth	36.197	79.963	36.197	mm"
"		Runoff volume	47.06	0.00	47.06	c.m"
"		Runoff coefficient	0.417	0.000	0.417	"
"		Maximum flow	0.016	0.000	0.016	c.m/sec"
" 40		HYDROGRAPH Add Runoff "				
"	4	Add Runoff "				
"		0.016	0.628	0.032	0.032"	
" 33		CATCHMENT 40"				
"	1	Triangular SCS"				
"	1	Equal length"				
"	1	SCS method"				
"	40	Catchment 40"				
"	0.000	% Impervious"				
"	7.120	Total Area"				
"	60.000	Flow length"				
"	2.000	Overland Slope"				
"	7.120	Pervious Area"				
"	60.000	Pervious length"				
"	2.000	Pervious slope"				
"	0.000	Impervious Area"				
"	60.000	Impervious length"				
"	2.000	Impervious slope"				
"	0.250	Pervious Manning 'n'"				
"	74.000	Pervious SCS Curve No."				
"	0.417	Pervious Runoff coefficient"				
"	0.100	Pervious Ia/S coefficient"				
"	8.924	Pervious Initial abstraction"				
"	0.015	Impervious Manning 'n'"				
"	98.000	Impervious SCS Curve No."				
"	0.000	Impervious Runoff coefficient"				
"	0.100	Impervious Ia/S coefficient"				
"	0.518	Impervious Initial abstraction"				
"		0.789	0.628	0.032	0.032 c.m/sec"	
"		Catchment 40	Pervious	Impervious	Total Area	"
"		Surface Area	7.120	0.000	7.120	hectare"
"		Time of concentration	21.990	2.837	21.990	minutes"
"		Time to Centroid	120.254	87.552	120.254	minutes"
"		Rainfall depth	86.737	86.737	86.737	mm"

```

Existing_50yr
" Rainfall volume 6175.65 0.01 6175.66 c.m"
" Rainfall losses 50.538 7.307 50.538 mm"
" Runoff depth 36.199 79.429 36.199 mm"
" Runoff volume 2577.38 0.01 2577.39 c.m"
" Runoff coefficient 0.417 0.000 0.417 "
" Maximum flow 0.789 0.000 0.789 c.m/sec"
40 HYDROGRAPH Add Runoff "
" 4 Add Runoff "
" 0.789 1.341 0.032 0.032"
54 POND DESIGN"
" 1.341 Current peak flow c.m/sec"
" 0.050 Target outflow c.m/sec"
" 5435.7 Hydrograph volume c.m"
" 6. Number of stages"
" 409.630 Minimum water level metre"
" 410.750 Maximum water level metre"
" 409.630 Starting water level metre"
" 0 Keep Design Data: 1 = True; 0 = False"
" Level Discharge Volume"
" 409.630 0.000 0.000"
" 409.750 0.6650 402.200"
" 410.000 3.601 2187.900"
" 410.250 7.811 5318.900"
" 410.500 12.984 9642.300"
" 410.750 18.965 15227.70"
" Peak outflow 1.183 c.m/sec"
" Maximum level 409.794 metre"
" Maximum storage 718.586 c.m"
" Centroidal lag 2.328 hours"
" 0.789 1.341 1.183 0.032 c.m/sec"
40 HYDROGRAPH Next link "
" 5 Next link "
" 0.789 1.183 1.183 0.032"
52 CHANNEL DESIGN"
" 1.183 Current peak flow c.m/sec"
" 0.035 Manning 'n'"
" 0. Cross-section type: 0=trapezoidal; 1=general"
" 0.000 Basewidth metre"
" 7.410 Left bank slope"
" 6.000 Right bank slope"
" 0.950 Channel depth metre"
" 1.040 Gradient %"
" Depth of flow 0.417 metre"
" Velocity 1.016 m/sec"
" Channel capacity 10.655 c.m/sec"
" Critical depth 0.364 metre"
53 ROUTE Channel Route 72"
" 72.40 Channel Route 72 Reach length (metre)"
" 0.396 X-factor <= 0.5"
" 53.425 K-lag (seconds)"
" 0.000 Default(0) or user spec.(1) values used"
" 0.500 X-factor <= 0.5"
" 30.000 K-lag (seconds)"
" 0.500 Beta weighting factor"
" 60.000 Routing time step (seconds)"
" 1 No. of sub-reaches"
" Peak outflow 1.180 c.m/sec"
" 0.789 1.183 1.180 0.032 c.m/sec"
40 HYDROGRAPH Next link "
" 5 Next link "
" 0.789 1.180 1.180 0.032"
52 CHANNEL DESIGN"
" 1.180 Current peak flow c.m/sec"

```

Existing__50yr

```

"      0.035 Manning 'n'"
"      0.      Cross-section type: 0=trapezoidal; 1=general"
"      2.000 Basewidth      metre"
"      2.950 Left bank slope"
"      3.000 Right bank slope"
"      0.950 Channel depth      metre"
"      1.040 Gradient      %"
"      Depth of flow      0.341      metre"
"      Velocity      1.150      m/sec"
"      Channel capacity      9.246      c.m/sec"
"      Critical depth      0.283      metre"
53  ROUTE      Channel Route 40"
"      39.80      Channel Route 40 Reach length      ( metre)"
"      0.282      X-factor <= 0.5"
"      25.955      K-lag      ( seconds)"
"      0.000      Default(0) or user spec.(1) values used"
"      0.500      X-factor <= 0.5"
"      30.000      K-lag      ( seconds)"
"      0.500      Beta weighting factor"
"      33.333      Routing time step      ( seconds)"
"      1      No. of sub-reaches"
"      Peak outflow      1.178      c.m/sec"
"      0.789      1.180      1.178      0.032 c.m/sec"
40  HYDROGRAPH Next link "
"      5      Next link "
"      0.789      1.178      1.178      0.032"
40  HYDROGRAPH Copy to Outflow"
"      8      Copy to Outflow"
"      0.789      1.178      1.178      0.032"
40  HYDROGRAPH Combine      1"
"      6      Combine "
"      1      Node #"
"      Total"
"      Maximum flow      1.178      c.m/sec"
"      Hydrograph volume      5435.679      c.m"
"      0.789      1.178      1.178      1.178"
40  HYDROGRAPH Start - New Tributary"
"      2      Start - New Tributary"
"      0.789      0.000      1.178      1.178"
33  CATCHMENT 20"
"      1      Triangular SCS"
"      1      Equal length"
"      1      SCS method"
"      20      Catchment 20"
"      0.000      % Impervious"
"      6.650      Total Area"
"      150.000      Flow length"
"      2.000      Overland Slope"
"      6.650      Pervious Area"
"      150.000      Pervious length"
"      2.000      Pervious slope"
"      0.000      Impervious Area"
"      150.000      Impervious length"
"      2.000      Impervious slope"
"      0.250      Pervious Manning 'n'"
"      74.000      Pervious SCS Curve No."
"      0.418      Pervious Runoff coefficient"
"      0.100      Pervious Ia/S coefficient"
"      8.924      Pervious Initial abstraction"
"      0.015      Impervious Manning 'n'"
"      98.000      Impervious SCS Curve No."
"      0.000      Impervious Runoff coefficient"
"      0.100      Impervious Ia/S coefficient"

```

```

Existing_50yr
" 0.518 Impervious Initial abstraction"
" 0.530 0.000 1.178 1.178 c.m/sec"
" Catchment 20 Pervious Impervious Total Area "
" Surface Area 6.650 0.000 6.650 hectare"
" Time of concentration 38.106 4.916 38.106 minutes"
" Time to Centroid 138.366 90.175 138.366 minutes"
" Rainfall depth 86.737 86.737 86.737 mm"
" Rainfall volume 5767.99 0.01 5768.00 c.m"
" Rainfall losses 50.510 5.941 50.510 mm"
" Runoff depth 36.227 80.796 36.227 mm"
" Runoff volume 2409.10 0.01 2409.10 c.m"
" Runoff coefficient 0.418 0.000 0.418 "
" Maximum flow 0.530 0.000 0.530 c.m/sec"
40 HYDROGRAPH Add Runoff "
" 4 Add Runoff "
" 0.530 0.530 1.178 1.178"
33 CATCHMENT 21"
" 1 Triangular SCS"
" 1 Equal length"
" 1 SCS method"
" 21 Catchment 20"
" 10.000 % Impervious"
" 0.820 Total Area"
" 40.000 Flow length"
" 2.000 Overland Slope"
" 0.738 Pervious Area"
" 40.000 Pervious length"
" 2.000 Pervious slope"
" 0.082 Impervious Area"
" 40.000 Impervious length"
" 2.000 Impervious slope"
" 0.250 Pervious Manning 'n'"
" 74.000 Pervious SCS Curve No."
" 0.417 Pervious Runoff coefficient"
" 0.100 Pervious Ia/S coefficient"
" 8.924 Pervious Initial abstraction"
" 0.015 Impervious Manning 'n'"
" 98.000 Impervious SCS Curve No."
" 0.922 Impervious Runoff coefficient"
" 0.100 Impervious Ia/S coefficient"
" 0.518 Impervious Initial abstraction"
" 0.103 0.530 1.178 1.178 c.m/sec"
" Catchment 21 Pervious Impervious Total Area "
" Surface Area 0.738 0.082 0.820 hectare"
" Time of concentration 17.241 2.224 14.282 minutes"
" Time to Centroid 114.897 86.667 109.333 minutes"
" Rainfall depth 86.737 86.737 86.737 mm"
" Rainfall volume 640.12 71.12 711.24 c.m"
" Rainfall losses 50.540 6.774 46.163 mm"
" Runoff depth 36.197 79.963 40.574 mm"
" Runoff volume 267.14 65.57 332.71 c.m"
" Runoff coefficient 0.417 0.922 0.468 "
" Maximum flow 0.091 0.031 0.103 c.m/sec"
40 HYDROGRAPH Add Runoff "
" 4 Add Runoff "
" 0.103 0.592 1.178 1.178"
40 HYDROGRAPH Copy to Outflow"
" 8 Copy to Outflow"
" 0.103 0.592 0.592 1.178"
64 SHOW TABLE"
" 2 Flow hydrograph"
" 4 Inflow Hydrograph"
" Maximum flow 0.592 c.m/sec"

```

"			Existing_50yr		
"	40	Hydrograph volume	2741.806	c.m"	
"		HYDROGRAPH	Combine	1"	
"		6	Combine	"	
"		1	Node #"		
"			Total"		
"		Maximum flow	1.754	c.m/sec"	
"		Hydrograph volume	8177.484	c.m"	
"			0.103	0.592	1.754"
"	38	START/RE-START TOTALS	21"		
"		3	Runoff Totals on EXIT"		
"		Total Catchment area		22.700	hectare"
"		Total Impervious area		0.082	hectare"
"		Total % impervious		0.361"	
"	19	EXIT"			

```

Existing__100yr
"
"      MIDUSS Output ----->"
"      MIDUSS version          Version 2.25 rev. 473"
"      MIDUSS created         Sunday, February 07, 2010"
"      10 Units used:         ie METRIC"
"      Job folder:           w:\Kitchener\411-2011\411009\Design Data\
"                               Modelling Files\2019-02-15"
"      Output filename:      Existing__100yr.out"
"      Licensee name:        gmbp"
"      Company               Hewlett-Packard Company"
"      Date & Time last used: 2/15/2019 at 2:20:28 PM"
" 31      TIME PARAMETERS"
"          5.000 Time Step"
"          180.000 Max. Storm length"
"          3600.000 Max. Hydrograph"
" 32      STORM Chicago storm"
"          1 Chicago storm"
"          6933.020 Coefficient A"
"          34.699 Constant B"
"          0.998 Exponent C"
"          0.380 Fraction R"
"          180.000 Duration"
"          1.000 Time step multiplier"
"          Maximum intensity      168.777 mm/hr"
"          Total depth            97.921 mm"
"          6 100hyd Hydrograph extension used in this file"
" 33      CATCHMENT 30"
"          1 Triangular SCS"
"          1 Equal length"
"          1 SCS method"
"          30 Catchment 30"
"          0.000 % Impervious"
"          0.220 Total Area"
"          20.000 Flow length"
"          2.000 Overland slope"
"          0.220 Pervious Area"
"          20.000 Pervious length"
"          2.000 Pervious slope"
"          0.000 Impervious Area"
"          20.000 Impervious length"
"          2.000 Impervious slope"
"          0.250 Pervious Manning 'n'"
"          74.000 Pervious SCS Curve No."
"          0.452 Pervious Runoff coefficient"
"          0.100 Pervious Ia/S coefficient"
"          8.924 Pervious Initial abstraction"
"          0.015 Impervious Manning 'n'"
"          98.000 Impervious SCS Curve No."
"          0.000 Impervious Runoff coefficient"
"          0.100 Impervious Ia/S coefficient"
"          0.518 Impervious Initial abstraction"
"          0.039      0.000      0.000      0.000 c.m/sec"
"          Catchment 30      Pervious      Impervious      Total Area
"          Surface Area      0.220      0.000      0.220      hectare"
"          Time of concentration 10.606      1.421      10.606      minutes"
"          Time to Centroid      106.728      85.423      106.728      minutes"
"          Rainfall depth      97.921      97.921      97.921      mm"
"          Rainfall volume      215.43      0.00      215.43      c.m"
"          Rainfall losses      53.628      6.787      53.628      mm"
"          Runoff depth      44.294      91.134      44.294      mm"
"          Runoff volume      97.45      0.00      97.45      c.m"
"          Runoff coefficient      0.452      0.000      0.452      "
"          Maximum flow      0.039      0.000      0.039      c.m/sec"
" 40      HYDROGRAPH Add Runoff "

```



```

Existing__100yr
"      4  Add Runoff "
"      0.039  0.039  0.000  0.000"
" 40  HYDROGRAPH Copy to Outflow"
"      8  Copy to Outflow"
"      0.039  0.039  0.039  0.000"
" 40  HYDROGRAPH Combine 2"
"      6  Combine "
"      2  Node #"
"      To Walser Street"
"      Maximum flow 0.039 c.m/sec"
"      Hydrograph volume 97.446 c.m"
"      0.039  0.039  0.039  0.039"
" 40  HYDROGRAPH Start - New Tributary"
"      2  Start - New Tributary"
"      0.039  0.000  0.039  0.039"
" 33  CATCHMENT 10"
"      1  Triangular SCS"
"      1  Equal length"
"      1  SCS method"
"      10  Catchment 10"
"      0.000  % Impervious"
"      7.760  Total Area"
"      150.000  Flow length"
"      2.000  Overland Slope"
"      7.760  Pervious Area"
"      150.000  Pervious length"
"      2.000  Pervious slope"
"      0.000  Impervious Area"
"      150.000  Impervious length"
"      2.000  Impervious slope"
"      0.250  Pervious Manning 'n'"
"      74.000  Pervious SCS Curve No."
"      0.454  Pervious Runoff coefficient"
"      0.100  Pervious Ia/S coefficient"
"      8.924  Pervious Initial abstraction"
"      0.015  Impervious Manning 'n'"
"      98.000  Impervious SCS Curve No."
"      0.000  Impervious Runoff coefficient"
"      0.100  Impervious Ia/S coefficient"
"      0.518  Impervious Initial abstraction"
"      0.801  0.000  0.039  0.039 c.m/sec"
"      Catchment 10 Pervious Impervious Total Area "
"      Surface Area 7.760 0.000 7.760 hectare"
"      Time of concentration 35.531 4.759 35.530 minutes"
"      Time to Centroid 134.554 89.737 134.554 minutes"
"      Rainfall depth 97.921 97.921 97.921 mm"
"      Rainfall volume 7598.69 0.01 7598.69 c.m"
"      Rainfall losses 53.501 6.084 53.501 mm"
"      Runoff depth 44.420 91.837 44.420 mm"
"      Runoff volume 3447.00 0.01 3447.01 c.m"
"      Runoff coefficient 0.454 0.000 0.454 "
"      Maximum flow 0.801 0.000 0.801 c.m/sec"
" 40  HYDROGRAPH Add Runoff "
"      4  Add Runoff "
"      0.801  0.801  0.039  0.039"
" 33  CATCHMENT 11"
"      1  Triangular SCS"
"      1  Equal length"
"      1  SCS method"
"      11  Catchment 11"
"      0.000  % Impervious"
"      0.130  Total Area"
"      40.000  Flow length"

```

Existing__100yr

```

"      2.000  Overland Slope"
"      0.130  Pervious Area"
"     40.000  Pervious length"
"      2.000  Pervious slope"
"      0.000  Impervious Area"
"     40.000  Impervious length"
"      2.000  Impervious slope"
"      0.250  Pervious Manning 'n'"
"     74.000  Pervious SCS Curve No."
"      0.453  Pervious Runoff coefficient"
"      0.100  Pervious Ia/S coefficient"
"      8.924  Pervious Initial abstraction"
"      0.015  Impervious Manning 'n'"
"     98.000  Impervious SCS Curve No."
"      0.000  Impervious Runoff coefficient"
"      0.100  Impervious Ia/S coefficient"
"      0.518  Impervious Initial abstraction"
"          0.020  0.801  0.039  0.039 c.m/sec"
"      Catchment 11  Pervious  Impervious  Total Area  "
"      Surface Area  0.130  0.000  0.130  hectare"
"      Time of concentration  16.076  2.153  16.076  minutes"
"      Time to Centroid  112.853  86.345  112.853  minutes"
"      Rainfall depth  97.921  97.921  97.921  mm"
"      Rainfall volume  127.30  0.00  127.30  c.m"
"      Rainfall losses  53.605  6.948  53.605  mm"
"      Runoff depth  44.316  90.973  44.316  mm"
"      Runoff volume  57.61  0.00  57.61  c.m"
"      Runoff coefficient  0.453  0.000  0.453  "
"      Maximum flow  0.020  0.000  0.020  c.m/sec"
" 40  HYDROGRAPH Add Runoff "
"      4  Add Runoff "
"          0.020  0.813  0.039  0.039"
" 33  CATCHMENT 40"
"      1  Triangular SCS"
"      1  Equal length"
"      1  SCS method"
"      40  Catchment 40"
"      0.000  % Impervious"
"      7.120  Total Area"
"     60.000  Flow length"
"      2.000  Overland Slope"
"      7.120  Pervious Area"
"     60.000  Pervious length"
"      2.000  Pervious slope"
"      0.000  Impervious Area"
"     60.000  Impervious length"
"      2.000  Impervious slope"
"      0.250  Pervious Manning 'n'"
"     74.000  Pervious SCS Curve No."
"      0.453  Pervious Runoff coefficient"
"      0.100  Pervious Ia/S coefficient"
"      8.924  Pervious Initial abstraction"
"      0.015  Impervious Manning 'n'"
"     98.000  Impervious SCS Curve No."
"      0.000  Impervious Runoff coefficient"
"      0.100  Impervious Ia/S coefficient"
"      0.518  Impervious Initial abstraction"
"          0.985  0.813  0.039  0.039 c.m/sec"
"      Catchment 40  Pervious  Impervious  Total Area  "
"      Surface Area  7.120  0.000  7.120  hectare"
"      Time of concentration  20.504  2.747  20.504  minutes"
"      Time to Centroid  117.777  87.189  117.777  minutes"
"      Rainfall depth  97.921  97.921  97.921  mm"

```

```

Existing__100yr
"      Rainfall volume      6971.99      0.01      6972.00      c.m"
"      Rainfall losses      53.532      7.496      53.532      mm"
"      Runoff depth          44.389      90.426      44.389      mm"
"      Runoff volume         3160.50      0.01      3160.50      c.m"
"      Runoff coefficient     0.453      0.000      0.453      "
"      Maximum flow          0.985      0.000      0.985      c.m/sec"
40    HYDROGRAPH Add Runoff "
"      4  Add Runoff "
"          0.985      1.721      0.039      0.039"
54    POND DESIGN"
"      1.721  Current peak flow      c.m/sec"
"      0.050  Target outflow      c.m/sec"
"      6665.1 Hydrograph volume      c.m"
"      6.      Number of stages"
"      409.630 Minimum water level      metre"
"      410.750 Maximum water level      metre"
"      409.630 Starting water level      metre"
"      0      Keep Design Data: 1 = True; 0 = False"
"          Level Discharge      volume"
"      409.630      0.000      0.000"
"      409.750      0.6650      402.200"
"      410.000      3.601      2187.900"
"      410.250      7.811      5318.900"
"      410.500      12.984      9642.300"
"      410.750      18.965      15227.70"
"      Peak outflow              1.507      c.m/sec"
"      Maximum level              409.822      metre"
"      Maximum storage            917.763      c.m"
"      Centroidal lag              2.275      hours"
"          0.985      1.721      1.507      0.039 c.m/sec"
40    HYDROGRAPH Next link "
"      5  Next link "
"          0.985      1.507      1.507      0.039"
52    CHANNEL DESIGN"
"      1.507  Current peak flow      c.m/sec"
"      0.035  Manning 'n'"
"      0.      Cross-section type: 0=trapezoidal; 1=general"
"      0.000  Basewidth      metre"
"      7.410  Left bank slope"
"      6.000  Right bank slope"
"      0.950  Channel depth      metre"
"      1.040  Gradient      %"
"          Depth of flow              0.456      metre"
"          Velocity                    1.080      m/sec"
"          Channel capacity            10.655      c.m/sec"
"          Critical depth              0.400      metre"
53    ROUTE      Channel Route 72"
"      72.40  Channel Route 72 Reach length      ( metre)"
"      0.386  X-factor <= 0.5"
"      50.288 K-lag      ( seconds)"
"      0.000  Default(0) or user spec.(1) values used"
"      0.500  X-factor <= 0.5"
"      30.000 K-lag      ( seconds)"
"      0.500  Beta weighting factor"
"      60.000 Routing time step      ( seconds)"
"      1      No. of sub-reaches"
"          Peak outflow              1.499      c.m/sec"
"          0.985      1.507      1.499      0.039 c.m/sec"
40    HYDROGRAPH Next link "
"      5  Next link "
"          0.985      1.499      1.499      0.039"
52    CHANNEL DESIGN"
"      1.499  Current peak flow      c.m/sec"

```

```

Existing__100yr
"      0.035  Manning 'n'"
"      0.      Cross-section type: 0=trapezoidal; 1=general"
"      2.000  Basewidth      metre"
"      2.950  Left bank slope"
"      3.000  Right bank slope"
"      0.950  Channel depth  metre"
"      1.040  Gradient      %"
"      Depth of flow      0.386  metre"
"      Velocity           1.232  m/sec"
"      Channel capacity   9.246  c.m/sec"
"      Critical depth     0.325  metre"
53  ROUTE Channel Route 40"
"      39.80 Channel Route 40 Reach length (metre)"
"      0.256 X-factor <= 0.5"
"      24.228 K-lag (seconds)"
"      0.000 Default(0) or user spec.(1) values used"
"      0.500 X-factor <= 0.5"
"      30.000 K-lag (seconds)"
"      0.500 Beta weighting factor"
"      33.333 Routing time step (seconds)"
"      1 No. of sub-reaches"
"      Peak outflow      1.499  c.m/sec"
"      0.985 1.499 1.499 0.039 c.m/sec"
40  HYDROGRAPH Next link "
"      5 Next link "
"      0.985 1.499 1.499 0.039"
40  HYDROGRAPH Copy to Outflow"
"      8 Copy to Outflow"
"      0.985 1.499 1.499 0.039"
40  HYDROGRAPH Combine 1"
"      6 Combine "
"      1 Node #"
"      Total"
"      Maximum flow      1.499  c.m/sec"
"      Hydrograph volume  6665.154 c.m"
"      0.985 1.499 1.499 1.499"
40  HYDROGRAPH Start - New Tributary"
"      2 Start - New Tributary"
"      0.985 0.000 1.499 1.499"
33  CATCHMENT 20"
"      1 Triangular SCS"
"      1 Equal length"
"      1 SCS method"
"      20 Catchment 20"
"      0.000 % Impervious"
"      6.650 Total Area"
"      150.000 Flow length"
"      2.000 Overland Slope"
"      6.650 Pervious Area"
"      150.000 Pervious length"
"      2.000 Pervious slope"
"      0.000 Impervious Area"
"      150.000 Impervious length"
"      2.000 Impervious slope"
"      0.250 Pervious Manning 'n'"
"      74.000 Pervious SCS Curve No."
"      0.454 Pervious Runoff coefficient"
"      0.100 Pervious Ia/S coefficient"
"      8.924 Pervious Initial abstraction"
"      0.015 Impervious Manning 'n'"
"      98.000 Impervious SCS Curve No."
"      0.000 Impervious Runoff coefficient"
"      0.100 Impervious Ia/S coefficient"

```

```

Existing__100yr
" 0.518 Impervious Initial abstraction"
" 0.687 0.000 1.499 1.499 c.m/sec"
" Catchment 20 Pervious Impervious Total Area "
" Surface Area 6.650 0.000 6.650 hectare"
" Time of concentration 35.531 4.759 35.530 minutes"
" Time to Centroid 134.554 89.737 134.554 minutes"
" Rainfall depth 97.921 97.921 97.921 mm"
" Rainfall volume 6511.76 0.01 6511.77 c.m"
" Rainfall losses 53.501 6.084 53.501 mm"
" Runoff depth 44.420 91.837 44.420 mm"
" Runoff volume 2953.94 0.01 2953.95 c.m"
" Runoff coefficient 0.454 0.000 0.454 "
" Maximum flow 0.687 0.000 0.687 c.m/sec"
40 HYDROGRAPH Add Runoff "
" 4 Add Runoff "
" 0.687 0.687 1.499 1.499"
33 CATCHMENT 21"
" 1 Triangular SCS"
" 1 Equal length"
" 1 SCS method"
" 21 Catchment 20"
" 10.000 % Impervious"
" 0.820 Total Area"
" 40.000 Flow length"
" 2.000 Overland Slope"
" 0.738 Pervious Area"
" 40.000 Pervious length"
" 2.000 Pervious slope"
" 0.082 Impervious Area"
" 40.000 Impervious length"
" 2.000 Impervious slope"
" 0.250 Pervious Manning 'n'"
" 74.000 Pervious SCS Curve No."
" 0.453 Pervious Runoff coefficient"
" 0.100 Pervious Ia/S coefficient"
" 8.924 Pervious Initial abstraction"
" 0.015 Impervious Manning 'n'"
" 98.000 Impervious SCS Curve No."
" 0.929 Impervious Runoff coefficient"
" 0.100 Impervious Ia/S coefficient"
" 0.518 Impervious Initial abstraction"
" 0.134 0.687 1.499 1.499 c.m/sec"
" Catchment 21 Pervious Impervious Total Area "
" Surface Area 0.738 0.082 0.820 hectare"
" Time of concentration 16.076 2.153 13.490 minutes"
" Time to Centroid 112.853 86.345 107.930 minutes"
" Rainfall depth 97.921 97.921 97.921 mm"
" Rainfall volume 722.66 80.30 802.95 c.m"
" Rainfall losses 53.605 6.948 48.939 mm"
" Runoff depth 44.316 90.973 48.982 mm"
" Runoff volume 327.05 74.60 401.65 c.m"
" Runoff coefficient 0.453 0.929 0.500 "
" Maximum flow 0.115 0.034 0.134 c.m/sec"
40 HYDROGRAPH Add Runoff "
" 4 Add Runoff "
" 0.134 0.763 1.499 1.499"
40 HYDROGRAPH Copy to Outflow"
" 8 Copy to Outflow"
" 0.134 0.763 0.763 1.499"
64 SHOW TABLE"
" 2 Flow hydrograph"
" 4 Inflow Hydrograph"
" Maximum flow 0.763 c.m/sec"

```

"			Existing__100yr		
"	40	Hydrograph volume	3355.597	c.m"	
"		HYDROGRAPH	Combine	1"	
"		6	Combine	"	
"		1	Node #"		
"			Total"		
"		Maximum flow	2.243	c.m/sec"	
"		Hydrograph volume	10020.747	c.m"	
"			0.134	0.763	0.763
"	38	START/RE-START TOTALS	21"		
"		3	Runoff Totals on EXIT"		
"		Total Catchment area		22.700	hectare"
"		Total Impervious area		0.082	hectare"
"		Total % impervious		0.361"	
"	19	EXIT"			

```

Existing_REG
" MIDUSS Output ----->"
" MIDUSS version Version 2.25 rev. 473"
" MIDUSS created Sunday, February 07, 2010"
" 10 Units used: ie METRIC"
" Job folder: w:\Kitchener\411-2011\411009\Design Data\
Modelling Files\2019-02-15"
" Output filename: Existing_REG.out"
" Licensee name: gmbp"
" Company Hewlett-Packard Company"
" Date & Time last used: 2/15/2019 at 2:27:05 PM"
" 31 TIME PARAMETERS"
" 60.000 Time Step"
" 2880.000 Max. Storm length"
" 12000.000 Max. Hydrograph"
" 32 STORM Historic"
" 5 Historic"
" 2880.000 Duration"
" 48.000 Rainfall intensity values"
" 2.028 2.028 2.028 2.028 2.028"
" 2.028 2.028 2.028 2.028 2.028"
" 2.028 2.028 2.028 2.028 2.028"
" 2.028 2.028 2.028 2.028 2.028"
" 2.028 2.028 2.028 2.028 2.028"
" 2.028 2.026 2.026 2.026 2.026"
" 2.026 6.000 4.000 6.000 13.000"
" 17.000 13.000 23.000 13.000 13.000"
" 53.000 38.000 13.000"
" Maximum intensity 53.000 mm/hr"
" Total depth 285.000 mm"
" 6 200hyd Hydrograph extension used in this file"
" 33 CATCHMENT 30"
" 1 Triangular SCS"
" 1 Equal length"
" 1 SCS method"
" 30 Catchment 30"
" 0.000 % Impervious"
" 0.220 Total Area"
" 20.000 Flow length"
" 2.000 Overland Slope"
" 0.220 Pervious Area"
" 20.000 Pervious length"
" 2.000 Pervious slope"
" 0.000 Impervious Area"
" 20.000 Impervious length"
" 2.000 Impervious slope"
" 0.250 Pervious Manning 'n'"
" 74.000 Pervious SCS Curve No."
" 0.713 Pervious Runoff coefficient"
" 0.100 Pervious Ia/S coefficient"
" 8.924 Pervious Initial abstraction"
" 0.015 Impervious Manning 'n'"
" 98.000 Impervious SCS Curve No."
" 0.000 Impervious Runoff coefficient"
" 0.100 Impervious Ia/S coefficient"
" 0.518 Impervious Initial abstraction"
" 0.024 0.000 0.000 0.000 c.m/sec"
" Catchment 30 Pervious Impervious Total Area "
" Surface Area 0.220 0.000 0.220 hectare"
" Time of concentration 12.633 2.243 12.633 minutes"
" Time to Centroid 2530.545 2290.972 2530.545 minutes"
" Rainfall depth 285.000 285.000 285.000 mm"
" Rainfall volume 627.00 0.00 627.00 c.m"

```

		Existing_REG			
"	Rainfall losses	81.839	43.972	81.839	mm"
"	Runoff depth	203.161	241.028	203.161	mm"
"	Runoff volume	446.95	0.00	446.95	c.m"
"	Runoff coefficient	0.713	0.000	0.713	"
"	Maximum flow	0.024	0.000	0.024	c.m/sec"
" 40	HYDROGRAPH Add Runoff "				
"	4 Add Runoff "				
"	0.024 0.024 0.000 0.000"				
" 40	HYDROGRAPH Copy to Outflow"				
"	8 Copy to Outflow"				
"	0.024 0.024 0.024 0.000"				
" 40	HYDROGRAPH Combine 2"				
"	6 Combine "				
"	2 Node #"				
"	To Walser Street"				
"	Maximum flow	0.024		c.m/sec"	
"	Hydrograph volume	446.953		c.m"	
"	0.024 0.024 0.024 0.024"				
" 40	HYDROGRAPH Start - New Tributary"				
"	2 Start - New Tributary"				
"	0.024 0.000 0.024 0.024"				
" 33	CATCHMENT 10"				
"	1 Triangular SCS"				
"	1 Equal length"				
"	1 SCS method"				
"	10 Catchment 10"				
"	0.000 % Impervious"				
"	7.760 Total Area"				
"	150.000 Flow length"				
"	2.000 Overland Slope"				
"	7.760 Pervious Area"				
"	150.000 Pervious length"				
"	2.000 Pervious slope"				
"	0.000 Impervious Area"				
"	150.000 Impervious length"				
"	2.000 Impervious slope"				
"	0.250 Pervious Manning 'n'"				
"	74.000 Pervious SCS Curve No."				
"	0.714 Pervious Runoff coefficient"				
"	0.100 Pervious Ia/S coefficient"				
"	8.924 Pervious Initial abstraction"				
"	0.015 Impervious Manning 'n'"				
"	98.000 Impervious SCS Curve No."				
"	0.000 Impervious Runoff coefficient"				
"	0.100 Impervious Ia/S coefficient"				
"	0.518 Impervious Initial abstraction"				
"	0.881 0.000 0.024 0.024 c.m/sec"				
"	Catchment 10 Pervious Impervious Total Area "				
"	Surface Area 7.760 0.000 7.760 hectare"				
"	Time of concentration 42.319 7.513 42.319 minutes"				
"	Time to Centroid 2572.242 2276.224 2572.241 minutes"				
"	Rainfall depth 285.000 285.000 285.000 mm"				
"	Rainfall volume 2.2116 0.0000 2.2116 ha-m"				
"	Rainfall losses 81.644 25.621 81.644 mm"				
"	Runoff depth 203.356 259.379 203.356 mm"				
"	Runoff volume 1.5780 0.0000 1.5780 ha-m"				
"	Runoff coefficient 0.714 0.000 0.714 "				
"	Maximum flow 0.881 0.000 0.881 c.m/sec"				
" 40	HYDROGRAPH Add Runoff "				
"	4 Add Runoff "				
"	0.881 0.881 0.024 0.024"				
" 33	CATCHMENT 11"				
"	1 Triangular SCS"				

Existing_REG

```

"      1 Equal length"
"      1 SCS method"
"     11 Catchment 11"
"     0.000 % Impervious"
"     0.130 Total Area"
"    40.000 Flow length"
"     2.000 Overland Slope"
"     0.130 Pervious Area"
"    40.000 Pervious length"
"     2.000 Pervious slope"
"     0.000 Impervious Area"
"    40.000 Impervious length"
"     2.000 Impervious slope"
"     0.250 Pervious Manning 'n'"
"    74.000 Pervious SCS Curve No."
"     0.723 Pervious Runoff coefficient"
"     0.100 Pervious Ia/S coefficient"
"     8.924 Pervious Initial abstraction"
"     0.015 Impervious Manning 'n'"
"    98.000 Impervious SCS Curve No."
"     0.000 Impervious Runoff coefficient"
"     0.100 Impervious Ia/S coefficient"
"     0.518 Impervious Initial abstraction"
"           0.014      0.881      0.024      0.024 c.m/sec"
"     Catchment 11      Pervious      Impervious      Total Area      "
"     Surface Area      0.130      0.000      0.130      hectare"
"     Time of concentration 19.148      3.399      19.148      minutes"
"     Time to Centroid 2545.193      2266.333      2545.193      minutes"
"     Rainfall depth      285.000      285.000      285.000      mm"
"     Rainfall volume      370.50      0.00      370.50      c.m"
"     Rainfall losses      78.940      42.646      78.940      mm"
"     Runoff depth      206.060      242.354      206.060      mm"
"     Runoff volume      267.88      0.00      267.88      c.m"
"     Runoff coefficient      0.723      0.000      0.723      "
"     Maximum flow      0.014      0.000      0.014      c.m/sec"
" 40 HYDROGRAPH Add Runoff "
"     4 Add Runoff "
"           0.014      0.894      0.024      0.024"
" 33 CATCHMENT 40"
"     1 Triangular SCS"
"     1 Equal length"
"     1 SCS method"
"     40 Catchment 40"
"     0.000 % Impervious"
"     7.120 Total Area"
"    60.000 Flow length"
"     2.000 Overland Slope"
"     7.120 Pervious Area"
"    60.000 Pervious length"
"     2.000 Pervious slope"
"     0.000 Impervious Area"
"    60.000 Impervious length"
"     2.000 Impervious slope"
"     0.250 Pervious Manning 'n'"
"    74.000 Pervious SCS Curve No."
"     0.716 Pervious Runoff coefficient"
"     0.100 Pervious Ia/S coefficient"
"     8.924 Pervious Initial abstraction"
"     0.015 Impervious Manning 'n'"
"    98.000 Impervious SCS Curve No."
"     0.000 Impervious Runoff coefficient"
"     0.100 Impervious Ia/S coefficient"
"     0.518 Impervious Initial abstraction"

```

```

Existing_REG
"      0.772      0.894      0.024      0.024 c.m/sec"
" Catchment 40      Pervious      Impervious      Total Area      "
" Surface Area      7.120      0.000      7.120      hectare"
" Time of concentration      24.421      4.336      24.421      minutes"
" Time to Centroid      2549.942      2258.969      2549.942      minutes"
" Rainfall depth      285.000      285.000      285.000      mm"
" Rainfall volume      2.0292      0.0000      2.0292      ha-m"
" Rainfall losses      80.848      39.404      80.848      mm"
" Runoff depth      204.152      245.596      204.152      mm"
" Runoff volume      1.4536      0.0000      1.4536      ha-m"
" Runoff coefficient      0.716      0.000      0.716      "
" Maximum flow      0.772      0.000      0.772      c.m/sec"
40 HYDROGRAPH Add Runoff "
" 4 Add Runoff "
"      0.772      1.667      0.024      0.024"
54 POND DESIGN"
" 1.667 Current peak flow      c.m/sec"
" 0.050 Target outflow      c.m/sec"
" 30583.9 Hydrograph volume      c.m"
" 6. Number of stages"
" 409.630 Minimum water level      metre"
" 410.750 Maximum water level      metre"
" 409.630 Starting water level      metre"
" 0 Keep Design Data: 1 = True; 0 = False"
" Level Discharge      volume"
" 409.630 0.000 0.000"
" 409.750 0.6650 402.200"
" 410.000 3.601 2187.900"
" 410.250 7.811 5318.900"
" 410.500 12.984 9642.300"
" 410.750 18.965 15227.70"
" Peak outflow      1.612      c.m/sec"
" Maximum level      409.831      metre"
" Maximum storage      977.909      c.m"
" Centroidal lag      42.858      hours"
" 0.772 1.667 1.612 0.024 c.m/sec"
40 HYDROGRAPH Next link "
" 5 Next link "
"      0.772      1.612      1.612      0.024"
52 CHANNEL DESIGN"
" 1.612 Current peak flow      c.m/sec"
" 0.035 Manning 'n'"
" 0. Cross-section type: 0=trapezoidal; 1=general"
" 0.000 Basewidth      metre"
" 7.410 Left bank slope"
" 6.000 Right bank slope"
" 0.950 Channel depth      metre"
" 1.040 Gradient      %"
" Depth of flow      0.468      metre"
" Velocity      1.098      m/sec"
" Channel capacity      10.655      c.m/sec"
" Critical depth      0.411      metre"
53 ROUTE Channel Route 72"
" 72.40 Channel Route 72 Reach length      ( metre)"
" 0.383 X-factor <= 0.5"
" 49.448 K-lag      ( seconds)"
" 0.000 Default(0) or user spec.(1) values used"
" 0.500 X-factor <= 0.5"
" 30.000 K-lag      ( seconds)"
" 0.500 Beta weighting factor"
" 60.000 Routing time step      ( seconds)"
" 1 No. of sub-reaches"
" Peak outflow      1.606      c.m/sec"

```

```

Existing_REG
" 0.772 1.612 1.606 0.024 c.m/sec"
" 40 HYDROGRAPH Next link "
" 5 Next link "
" 0.772 1.606 1.606 0.024"
" 52 CHANNEL DESIGN"
" 1.606 Current peak flow c.m/sec"
" 0.035 Manning 'n'"
" 0. Cross-section type: 0=trapezoidal; 1=general"
" 2.000 Basewidth metre"
" 2.950 Left bank slope"
" 3.000 Right bank slope"
" 0.950 Channel depth metre"
" 1.040 Gradient %"
" Depth of flow 0.401 metre"
" Velocity 1.256 m/sec"
" Channel capacity 9.246 c.m/sec"
" Critical depth 0.339 metre"
" 53 ROUTE Channel Route 40"
" 39.80 Channel Route 40 Reach length (metre)"
" 0.248 X-factor <= 0.5"
" 23.758 K-lag (seconds)"
" 0.000 Default(0) or user spec.(1) values used"
" 0.500 X-factor <= 0.5"
" 30.000 K-lag (seconds)"
" 0.500 Beta weighting factor"
" 35.644 Routing time step (seconds)"
" 1 No. of sub-reaches"
" Peak outflow 1.603 c.m/sec"
" 0.772 1.606 1.603 0.024 c.m/sec"
" 40 HYDROGRAPH Next link "
" 5 Next link "
" 0.772 1.603 1.603 0.024"
" 40 HYDROGRAPH Copy to Outflow"
" 8 Copy to Outflow"
" 0.772 1.603 1.603 0.024"
" 40 HYDROGRAPH Combine 1"
" 6 Combine "
" 1 Node #"
" Total"
" Maximum flow 1.603 c.m/sec"
" Hydrograph volume 30582.604 c.m"
" 0.772 1.603 1.603 1.603"
" 40 HYDROGRAPH Start - New Tributary"
" 2 Start - New Tributary"
" 0.772 0.000 1.603 1.603"
" 33 CATCHMENT 20"
" 1 Triangular SCS"
" 1 Equal length"
" 1 SCS method"
" 20 Catchment 20"
" 0.000 % Impervious"
" 6.650 Total Area"
" 150.000 Flow length"
" 2.000 Overland Slope"
" 6.650 Pervious Area"
" 150.000 Pervious length"
" 2.000 Pervious slope"
" 0.000 Impervious Area"
" 150.000 Impervious length"
" 2.000 Impervious slope"
" 0.250 Pervious Manning 'n'"
" 74.000 Pervious SCS Curve No."
" 0.714 Pervious Runoff coefficient"

```

		Existing_REG				
"	0.100	Pervious Ia/S coefficient"				
"	8.924	Pervious Initial abstraction"				
"	0.015	Impervious Manning 'n'"				
"	98.000	Impervious SCS Curve No."				
"	0.000	Impervious Runoff coefficient"				
"	0.100	Impervious Ia/S coefficient"				
"	0.518	Impervious Initial abstraction"				
"		0.755	0.000	1.603	1.603 c.m/sec"	
"		Catchment 20	Pervious	Impervious	Total Area	"
"		Surface Area	6.650	0.000	6.650	hectare"
"		Time of concentration	42.319	7.513	42.319	minutes"
"		Time to Centroid	2572.242	2276.224	2572.241	minutes"
"		Rainfall depth	285.000	285.000	285.000	mm"
"		Rainfall volume	1.8952	0.0000	1.8952	ha-m"
"		Rainfall losses	81.644	25.621	81.644	mm"
"		Runoff depth	203.356	259.379	203.356	mm"
"		Runoff volume	1.3523	0.0000	1.3523	ha-m"
"		Runoff coefficient	0.714	0.000	0.714	"
"		Maximum flow	0.755	0.000	0.755	c.m/sec"
" 40		HYDROGRAPH Add Runoff "				
"	4	Add Runoff "				
"		0.755	0.755	1.603	1.603"	
" 33		CATCHMENT 21"				
"	1	Triangular SCS"				
"	1	Equal length"				
"	1	SCS method"				
"	21	Catchment 20"				
"	10.000	% Impervious"				
"	0.820	Total Area"				
"	40.000	Flow length"				
"	2.000	Overland Slope"				
"	0.738	Pervious Area"				
"	40.000	Pervious length"				
"	2.000	Pervious slope"				
"	0.082	Impervious Area"				
"	40.000	Impervious length"				
"	2.000	Impervious slope"				
"	0.250	Pervious Manning 'n'"				
"	74.000	Pervious SCS Curve No."				
"	0.723	Pervious Runoff coefficient"				
"	0.100	Pervious Ia/S coefficient"				
"	8.924	Pervious Initial abstraction"				
"	0.015	Impervious Manning 'n'"				
"	98.000	Impervious SCS Curve No."				
"	0.850	Impervious Runoff coefficient"				
"	0.100	Impervious Ia/S coefficient"				
"	0.518	Impervious Initial abstraction"				
"		0.087	0.755	1.603	1.603 c.m/sec"	
"		Catchment 21	Pervious	Impervious	Total Area	"
"		Surface Area	0.738	0.082	0.820	hectare"
"		Time of concentration	19.148	3.399	17.327	minutes"
"		Time to Centroid	2545.193	2266.333	2512.963	minutes"
"		Rainfall depth	285.000	285.000	285.000	mm"
"		Rainfall volume	2103.30	233.70	2337.00	c.m"
"		Rainfall losses	78.940	42.646	75.310	mm"
"		Runoff depth	206.060	242.354	209.690	mm"
"		Runoff volume	1520.72	198.73	1719.45	c.m"
"		Runoff coefficient	0.723	0.850	0.736	"
"		Maximum flow	0.078	0.010	0.087	c.m/sec"
" 40		HYDROGRAPH Add Runoff "				
"	4	Add Runoff "				
"		0.087	0.840	1.603	1.603"	
" 40		HYDROGRAPH Copy to Outflow"				

			Existing_REG		
"	8	Copy to Outflow"			
"		0.087	0.840	0.840	1.603"
" 64		SHOW TABLE"			
"	2	Flow hydrograph"			
"	4	Inflow Hydrograph"			
"		Maximum flow		0.840	c.m/sec"
"		Hydrograph volume		15242.604	c.m"
" 40		HYDROGRAPH Combine	1"		
"	6	Combine "			
"	1	Node #"			
"		Total"			
"		Maximum flow		2.443	c.m/sec"
"		Hydrograph volume		45825.211	c.m"
"		0.087	0.840	0.840	2.443"
" 38		START/RE-START TOTALS 21"			
"	3	Runoff Totals on EXIT"			
"		Total Catchment area		22.700	hectare"
"		Total Impervious area		0.082	hectare"
"		Total % impervious		0.361"	
" 19		EXIT"			

```

"                                     Allowable_10yr
"
" MIDUSS Output ----->"
" MIDUSS version                      Version 2.25 rev. 473"
" MIDUSS created                      Sunday, February 07, 2010"
" 10  Units used:                      ie METRIC"
" Job folder:                          w:\Kitchener\411-2011\411009\Design Data\
"                                     Modelling Files\2019-02-15"
" Output filename:                     Allowable_10yr.out"
" Licensee name:                       gmbp"
" Company                              Hewlett-Packard Company"
" Date & Time last used:                2/15/2019 at 5:00:51 PM"
" 31  TIME PARAMETERS"
"      5.000 Time Step"
"      180.000 Max. Storm length"
" 12000.000 Max. Hydrograph"
" 32  STORM Chicago storm"
"      1 Chicago storm"
"      2327.600 Coefficient A"
"      19.500 Constant B"
"      0.894 Exponent C"
"      0.380 Fraction R"
"      180.000 Duration"
"      1.000 Time step multiplier"
"      Maximum intensity                126.171 mm/hr"
"      Total depth                      61.359 mm"
"      6 010hyd Hydrograph extension used in this file"
" 33  CATCHMENT 1"
"      1 Triangular SCS"
"      1 Equal length"
"      1 SCS method"
"      1 Area Included in Subdivision Design"
"      60.000 % Impervious"
"      0.650 Total Area"
"      20.000 Flow length"
"      2.000 Overland slope"
"      0.260 Pervious Area"
"      20.000 Pervious length"
"      2.000 Pervious slope"
"      0.390 Impervious Area"
"      20.000 Impervious length"
"      2.000 Impervious slope"
"      0.250 Pervious Manning 'n'"
"      78.000 Pervious SCS Curve No."
"      0.379 Pervious Runoff coefficient"
"      0.100 Pervious Ia/S coefficient"
"      7.164 Pervious Initial abstraction"
"      0.015 Impervious Manning 'n'"
"      98.000 Impervious SCS Curve No."
"      0.901 Impervious Runoff coefficient"
"      0.100 Impervious Ia/S coefficient"
"      0.518 Impervious Initial abstraction"
"      0.122      0.000      0.000      0.000 c.m/sec"
"      Catchment 1 Pervious Impervious Total Area "
"      Surface Area      0.260      0.390      0.650 hectare"
"      Time of concentration 13.094      1.611      4.125 minutes"
"      Time to Centroid 111.234      86.563      91.965 minutes"
"      Rainfall depth      61.359      61.359      61.359 mm"
"      Rainfall volume      159.53      239.30      398.84 c.m"
"      Rainfall losses      38.098      6.044      18.866 mm"
"      Runoff depth      23.262      55.315      42.494 mm"
"      Runoff volume      60.48      215.73      276.21 c.m"
"      Runoff coefficient      0.379      0.901      0.693 "
"      Maximum flow      0.023      0.112      0.122 c.m/sec"
" 40  HYDROGRAPH Add Runoff "

```

			Allowable_10yr		
"	4	Add Runoff "			
"			0.122	0.122	0.000
" 38		START/RE-START TOTALS 1"			0.000"
"	3	Runoff Totals on EXIT"			
"		Total Catchment area		0.650	hectare"
"		Total Impervious area		0.390	hectare"
"		Total % impervious		60.000"	
" 19		EXIT"			

```

Allowable_25yr
"
" MIDUSS Output ----->"
" MIDUSS version Version 2.25 rev. 473"
" MIDUSS created Sunday, February 07, 2010"
" 10 Units used: ie METRIC"
" Job folder: w:\Kitchener\411-2011\411009\Design Data\
" Modelling Files\2019-02-15"
" Output filename: Allowable_25yr.out"
" Licensee name: gmbp"
" Company Hewlett-Packard Company"
" Date & Time last used: 2/15/2019 at 5:05:43 PM"
" 31 TIME PARAMETERS"
" 5.000 Time Step"
" 180.000 Max. Storm length"
" 12000.000 Max. Hydrograph"
" 32 STORM Chicago storm"
" 1 Chicago storm"
" 3701.648 Coefficient A"
" 25.500 Constant B"
" 0.937 Exponent C"
" 0.380 Fraction R"
" 180.000 Duration"
" 1.000 Time step multiplier"
" Maximum intensity 143.371 mm/hr"
" Total depth 75.581 mm"
" 6 025hyd Hydrograph extension used in this file"
" 33 CATCHMENT 1"
" 1 Triangular SCS"
" 1 Equal length"
" 1 SCS method"
" 1 Area Included in Subdivision Design"
" 60.000 % Impervious"
" 0.650 Total Area"
" 20.000 Flow length"
" 2.000 Overland slope"
" 0.260 Pervious Area"
" 20.000 Pervious length"
" 2.000 Pervious slope"
" 0.390 Impervious Area"
" 20.000 Impervious length"
" 2.000 Impervious slope"
" 0.250 Pervious Manning 'n'"
" 78.000 Pervious SCS Curve No."
" 0.441 Pervious Runoff coefficient"
" 0.100 Pervious Ia/S coefficient"
" 7.164 Pervious Initial abstraction"
" 0.015 Impervious Manning 'n'"
" 98.000 Impervious SCS Curve No."
" 0.916 Impervious Runoff coefficient"
" 0.100 Impervious Ia/S coefficient"
" 0.518 Impervious Initial abstraction"
" 0.150 0.000 0.000 0.000 c.m/sec"
" Catchment 1 Pervious Impervious Total Area "
" Surface Area 0.260 0.390 0.650 hectare"
" Time of concentration 11.553 1.523 3.959 minutes"
" Time to Centroid 108.042 85.984 91.342 minutes"
" Rainfall depth 75.581 75.581 75.581 mm"
" Rainfall volume 196.51 294.77 491.28 c.m"
" Rainfall losses 42.253 6.330 20.699 mm"
" Runoff depth 33.328 69.250 54.881 mm"
" Runoff volume 86.65 270.08 356.73 c.m"
" Runoff coefficient 0.441 0.916 0.726 "
" Maximum flow 0.035 0.132 0.150 c.m/sec"
" 40 HYDROGRAPH Add Runoff "

```

			Allowable_25yr		
"	4	Add Runoff "			
"			0.150	0.150	0.000
" 38		START/RE-START TOTALS 1"			0.000"
"	3	Runoff Totals on EXIT"			
"		Total Catchment area		0.650	hectare"
"		Total Impervious area		0.390	hectare"
"		Total % impervious		60.000"	
" 19		EXIT"			

```

Allowable_50yr
"
" MIDUSS Output ----->"
" MIDUSS version Version 2.25 rev. 473"
" MIDUSS created Sunday, February 07, 2010"
" 10 Units used: ie METRIC"
" Job folder: w:\Kitchener\411-2011\411009\Design Data\
" Modelling Files\2019-02-15"
" Output filename: Allowable_50yr.out"
" Licensee name: gmbp"
" Company Hewlett-Packard Company"
" Date & Time last used: 2/15/2019 at 5:06:49 PM"
" 31 TIME PARAMETERS"
" 5.000 Time Step"
" 180.000 Max. Storm length"
" 12000.000 Max. Hydrograph"
" 32 STORM Chicago storm"
" 1 Chicago storm"
" 5089.418 Coefficient A"
" 30.000 Constant B"
" 0.967 Exponent C"
" 0.380 Fraction R"
" 180.000 Duration"
" 1.000 Time step multiplier"
" Maximum intensity 156.350 mm/hr"
" Total depth 86.737 mm"
" 6 050hyd Hydrograph extension used in this file"
" 33 CATCHMENT 1"
" 1 Triangular SCS"
" 1 Equal length"
" 1 SCS method"
" 1 Area Included in Subdivision Design"
" 60.000 % Impervious"
" 0.650 Total Area"
" 20.000 Flow length"
" 2.000 Overland slope"
" 0.260 Pervious Area"
" 20.000 Pervious length"
" 2.000 Pervious slope"
" 0.390 Impervious Area"
" 20.000 Impervious length"
" 2.000 Impervious slope"
" 0.250 Pervious Manning 'n'"
" 78.000 Pervious SCS Curve No."
" 0.481 Pervious Runoff coefficient"
" 0.100 Pervious Ia/S coefficient"
" 7.164 Pervious Initial abstraction"
" 0.015 Impervious Manning 'n'"
" 98.000 Impervious SCS Curve No."
" 0.924 Impervious Runoff coefficient"
" 0.100 Impervious Ia/S coefficient"
" 0.518 Impervious Initial abstraction"
" 0.173 0.000 0.000 0.000 c.m/sec"
" Catchment 1 Pervious Impervious Total Area "
" Surface Area 0.260 0.390 0.650 hectare"
" Time of concentration 10.695 1.467 3.845 minutes"
" Time to Centroid 106.283 85.675 90.985 minutes"
" Rainfall depth 86.737 86.737 86.737 mm"
" Rainfall volume 225.52 338.27 563.79 c.m"
" Rainfall losses 44.994 6.561 21.934 mm"
" Runoff depth 41.743 80.176 64.803 mm"
" Runoff volume 108.53 312.68 421.22 c.m"
" Runoff coefficient 0.481 0.924 0.747 "
" Maximum flow 0.045 0.146 0.173 c.m/sec"
" 40 HYDROGRAPH Add Runoff "

```

			Allowable_50yr		
"	4	Add Runoff "			
"			0.173	0.173	0.000
" 38		START/RE-START TOTALS 1"			0.000"
"	3	Runoff Totals on EXIT"			
"		Total Catchment area		0.650	hectare"
"		Total Impervious area		0.390	hectare"
"		Total % impervious		60.000"	
" 19		EXIT"			

```

Allowable_100yr
"
" MIDUSS Output ----->"
" MIDUSS version Version 2.25 rev. 473"
" MIDUSS created Sunday, February 07, 2010"
" 10 Units used: ie METRIC"
" Job folder: w:\Kitchener\411-2011\411009\Design Data\
" Modelling Files\2019-02-15"
" Output filename: Allowable_100yr.out"
" Licensee name: gmbp"
" Company Hewlett-Packard Company"
" Date & Time last used: 2/15/2019 at 5:07:38 PM"
" 31 TIME PARAMETERS"
" 5.000 Time Step"
" 180.000 Max. Storm length"
" 12000.000 Max. Hydrograph"
" 32 STORM Chicago storm"
" 1 Chicago storm"
" 6933.019 Coefficient A"
" 34.699 Constant B"
" 0.998 Exponent C"
" 0.380 Fraction R"
" 180.000 Duration"
" 1.000 Time step multiplier"
" Maximum intensity 168.777 mm/hr"
" Total depth 97.921 mm"
" 6 100hyd Hydrograph extension used in this file"
" 33 CATCHMENT 1"
" 1 Triangular SCS"
" 1 Equal length"
" 1 SCS method"
" 1 Area Included in Subdivision Design"
" 60.000 % Impervious"
" 0.650 Total Area"
" 20.000 Flow length"
" 2.000 Overland Slope"
" 0.260 Pervious Area"
" 20.000 Pervious length"
" 2.000 Pervious slope"
" 0.390 Impervious Area"
" 20.000 Impervious length"
" 2.000 Impervious slope"
" 0.250 Pervious Manning 'n'"
" 78.000 Pervious SCS Curve No."
" 0.515 Pervious Runoff coefficient"
" 0.100 Pervious Ia/S coefficient"
" 7.164 Pervious Initial abstraction"
" 0.015 Impervious Manning 'n'"
" 98.000 Impervious SCS Curve No."
" 0.931 Impervious Runoff coefficient"
" 0.100 Impervious Ia/S coefficient"
" 0.518 Impervious Initial abstraction"
" 0.196 0.000 0.000 0.000 c.m/sec"
" Catchment 1 Pervious Impervious Total Area "
" Surface Area 0.260 0.390 0.650 hectare"
" Time of concentration 10.027 1.421 3.740 minutes"
" Time to Centroid 104.871 85.423 90.664 minutes"
" Rainfall depth 97.921 97.921 97.921 mm"
" Rainfall volume 254.60 381.89 636.49 c.m"
" Rainfall losses 47.483 6.787 23.065 mm"
" Runoff depth 50.438 91.134 74.856 mm"
" Runoff volume 131.14 355.42 486.56 c.m"
" Runoff coefficient 0.515 0.931 0.764 "
" Maximum flow 0.055 0.160 0.196 c.m/sec"
" 40 HYDROGRAPH Add Runoff "

```

			Allowable_100yr		
"	4	Add Runoff "			
"			0.196	0.196	0.000
" 38		START/RE-START TOTALS 1"			0.000"
"	3	Runoff Totals on EXIT"			
"		Total Catchment area		0.650	hectare"
"		Total Impervious area		0.390	hectare"
"		Total % impervious		60.000"	
" 19		EXIT"			

```

Allowable_REG
" MIDUSS Output ----->"
" MIDUSS version Version 2.25 rev. 473"
" MIDUSS created Sunday, February 07, 2010"
" 10 Units used: ie METRIC"
" Job folder: w:\Kitchener\411-2011\411009\Design Data\
Modelling Files\2019-02-15"
" Output filename: Allowable_REG.out"
" Licensee name: gmbp"
" Company Hewlett-Packard Company"
" Date & Time last used: 2/15/2019 at 5:09:43 PM"
" 31 TIME PARAMETERS"
" 60.000 Time Step"
" 2880.000 Max. Storm length"
" 12000.000 Max. Hydrograph"
" 32 STORM Historic"
" 5 Historic"
" 2880.000 Duration"
" 48.000 Rainfall intensity values"
" 2.028 2.028 2.028 2.028 2.028"
" 2.028 2.028 2.028 2.028 2.028"
" 2.028 2.028 2.028 2.028 2.028"
" 2.028 2.028 2.028 2.028 2.028"
" 2.028 2.028 2.028 2.028 2.028"
" 2.028 2.026 2.026 2.026 2.026"
" 2.026 6.000 4.000 6.000 13.000"
" 17.000 13.000 23.000 13.000 13.000"
" 53.000 38.000 13.000"
" Maximum intensity 53.000 mm/hr"
" Total depth 285.000 mm"
" 6 000hyd Hydrograph extension used in this file"
" 33 CATCHMENT 1"
" 1 Triangular SCS"
" 1 Equal length"
" 1 SCS method"
" 1 1"
" 60.000 % Impervious"
" 0.650 Total Area"
" 20.000 Flow length"
" 2.000 Overland Slope"
" 0.260 Pervious Area"
" 20.000 Pervious length"
" 2.000 Pervious slope"
" 0.390 Impervious Area"
" 20.000 Impervious length"
" 2.000 Impervious slope"
" 0.250 Pervious Manning 'n'"
" 78.000 Pervious SCS Curve No."
" 0.754 Pervious Runoff coefficient"
" 0.100 Pervious Ia/S coefficient"
" 7.164 Pervious Initial abstraction"
" 0.015 Impervious Manning 'n'"
" 98.000 Impervious SCS Curve No."
" 0.846 Impervious Runoff coefficient"
" 0.100 Impervious Ia/S coefficient"
" 0.518 Impervious Initial abstraction"
" 0.080 0.000 0.000 0.000 c.m/sec"
" Catchment 1 Pervious Impervious Total Area "
" Surface Area 0.260 0.390 0.650 hectare"
" Time of concentration 12.485 2.243 6.061 minutes"
" Time to Centroid 2505.276 2290.972 2370.872 minutes"
" Rainfall depth 285.000 285.000 285.000 mm"
" Rainfall volume 741.00 1111.50 1852.50 c.m"

```

		Allowable_REG			
"	Rainfall losses	70.073	43.972	54.413	mm"
"	Runoff depth	214.927	241.028	230.587	mm"
"	Runoff volume	558.81	940.01	1498.82	c.m"
"	Runoff coefficient	0.754	0.846	0.809	"
"	Maximum flow	0.030	0.050	0.080	c.m/sec"
" 40	HYDROGRAPH Add Runoff "				
"	4 Add Runoff "				
"		0.080	0.080	0.000	0.000"
" 38	START/RE-START TOTALS 1"				
"	3 Runoff Totals on EXIT"				
"	Total Catchment area			0.650	hectare"
"	Total Impervious area			0.390	hectare"
"	Total % impervious			60.000"	
" 19	EXIT"				

Ainley Farm Subdivision
Our File: 411009
February 2019

Catchment 1200: Proposed Infiltration Gallery

STORAGE VOLUME CALCULATIONS

ELEV	INC	SURFACE	INCR.	INCR.	ACCUM
(m)	D	AREA	PIPE	GALLERY	STORAGE
	(m)	(Infil. Gall)	STORAGE	STORAGE	VOL
		(sq m)	VOL	VOL	(cu m)
			(cu m)	(cu m)	
411.830	0.000	597.50	0.00	0.00	0.00 Bottom of Stone
411.930	0.100	597.50	0.00	19.92	19.92
412.230	0.400	597.50	95.85	27.80	143.57
412.530	0.700	597.50	95.85	27.80	267.22
412.630	0.800	597.50	0.00	19.92	287.13
412.700	0.870	597.50	0.00	13.94	301.07 Top of Stone
412.800	0.970	1.85	0.00	0.06	301.14
413.000	1.170	1.85	0.00	0.12	301.26
413.230	1.400	1.85	0.00	0.14	301.40 Weir (1)
413.430	1.600	5.00	0.00	0.33	301.74
413.630	1.800	10.00	0.00	0.67	302.40
413.830	2.000	15.00	0.00	1.00	303.40
414.030	2.200	20.00	0.00	1.33	304.74
414.090	2.260	25.00	0.00	0.50	305.24 Weir (2)
414.290	2.460	30.00	0.00	2.00	307.24
414.490	2.660	35.00	0.00	2.33	309.57 Overflow

BOTTOM INFILTRATION

L1(dw) =	85.0	m
W1(dw) =	3.5	m
L2(dw) =	60.0	m
W2(dw) =	5.0	m
D(dw) =	0.87	m
A(c) =	597.5	sq m
VOL(dw)=	328.1	cu m
VOL(st)=	109.4	cu m
K =	4	mm/hr
=	1.11E-04	cm/s

SIDE INFILTRATION

ALL SIDES

L1(dw) =	85.0	m
W1(dw) =	3.5	m
L2(dw) =	60.0	m
W2(dw) =	5.0	m
D(dw) =	0.87	m
A(c) =	267.1	sq m
K =	4	mm/hr
=	1.11E-04	cm/s

Weir (1)

Elevation = 413.23

d1 =	2.66	m
h =	1.40	m
H =	1.26	m
2g =	19.620	
L =	0.36	m
Q =	0.790	m ³ /s

Weir (2)

Elevation = 414.09

d1 =	2.66	m
h =	2.26	m
H =	0.40	m
2g =	19.620	
L =	0.36	m
Q =	0.128	m ³ /s

ELEVATION	STAGE (m)	STORAGE (cu m)	INFILTRATION DISCHARGE (cu m/s)	OVERFLOW WEIR (cu m/s)	OVERFLOW WEIR (cu m/s)	TOTAL DISCHARGE (cu m/s)	
411.830	0.000	0.00	0.0003	0.000	0.000	0.0003	Bottom of Stone
411.930	0.100	19.92	0.0003	0.000	0.000	0.0003	
412.230	0.400	143.57	0.0003	0.000	0.000	0.0003	
412.530	0.700	267.22	0.0003	0.000	0.000	0.0003	
412.630	0.800	287.13	0.0003	0.000	0.000	0.0003	
412.700	0.870	301.07	0.0003	0.000	0.000	0.0003	Top of Stone
412.800	0.970	301.14	0.0003	0.000	0.000	0.0003	
413.000	1.170	301.26	0.0003	0.000	0.000	0.0003	
413.230	1.400	301.40	0.0003	0.000	0.000	0.0003	Weir (1)
413.430	1.600	301.74	0.0000	0.045	0.000	0.0451	
413.630	1.800	302.40	0.0000	0.131	0.000	0.1310	
413.830	2.000	303.40	0.0000	0.246	0.000	0.2461	
414.030	2.200	304.74	0.0000	0.386	0.000	0.3862	
414.090	2.260	305.24	0.0000	0.433	0.000	0.4327	Weir (2)
414.290	2.460	307.24	0.0000	0.602	0.045	0.6461	
414.490	2.660	309.57	0.0000	0.790	0.128	0.9189	Overflow

Ainley Farm Subdivision
Our File: 411009
February 2019

Catchment 1400: Proposed Infiltration Gallery

STORAGE VOLUME CALCULATIONS

ELEV	INC	SURFACE	INCR.	INCR.	ACCUM	
	D	AREA	PIPE	GALLERY	STORAGE	
(m)	(m)	(sq m)	STORAGE	STORAGE	VOL	
			VOL	VOL	(cu m)	
			(cu m)	(cu m)		
413.920	0.000	800.00	0.00	0.00	0.00	Bottom of Stone
414.020	0.100	800.00	0.00	26.67	26.67	
414.120	0.200	800.00	1.91	26.03	54.61	
414.220	0.300	800.00	1.91	26.03	82.54	
414.320	0.400	800.00	1.91	26.03	110.48	
414.420	0.500	800.00	1.91	26.03	138.42	
414.520	0.600	800.00	0.00	26.67	165.09	
414.620	0.700	800.00	0.00	26.67	191.76	Top of Stone
414.720	0.800	0.72	0.07	0.00	191.83	Pipe Invert
414.820	0.900	0.72	0.07	0.00	191.90	
414.920	1.000	0.72	0.07	0.00	191.97	
415.020	1.100	0.72	0.07	0.00	192.04	
415.120	1.200	0.72	0.07	0.00	192.12	Top of Grate
415.220	1.300	185.00	9.29	0.00	201.40	
415.320	1.400	565.00	37.50	0.00	238.90	
415.420	1.500	750.00	65.75	0.00	304.65	Weir
415.520	1.600	800.00	77.50	0.00	382.15	Overflow

BOTTOM INFILTRATION

L1(dw) = 80.0 m
W1(dw) = 10.0 m
D(dw) = 0.70 m

A(c) = 800.0 sq m
VOL(dw)= 560.0 cu m
VOL(st)= 186.7 cu m
K = 4 mm/hr
= 1.11E-04 cm/s

SIDE INFILTRATION

ALL SIDES

L1(dw) = 80.0 m
W1(dw) = 10.0 m
D(dw) = 0.7 m

A(c) = 126.0 sq m

K = 4 mm/hr
= 1.11E-04 cm/s

Pipe Outlet

300 mm diameter pipe
200 mm orifice
Q = 0.075 m³/s
Cd = 0.6
H = 0.80 m
2g = 19.62

A = 0.031 m²
D = 0.2 m
D/2 = 0.1 m

Overflow Weir

Elevation = 411.90
d1 = 1.600 m
h = 1.500 m
H = 0.100 m
2g = 19.620
L = 5.000 m

Q = 0.218 m³/s

ELEVATION	STAGE (m)	STORAGE (cu m)	INFILTRATION DISCHARGE (cu m/s)	PIPE DISCHARGE (cu m/s)	OVERFLOW WEIR (cu m/s)	TOTAL DISCHARGE (cu m/s)	
413.920	0.000	0.00	0.0009	0.000	0.000	0.0009	Bottom of Stone
414.020	0.100	26.67	0.0009	0.000	0.000	0.0009	
414.120	0.200	54.61	0.0009	0.000	0.000	0.0009	
414.220	0.300	82.54	0.0009	0.000	0.000	0.0009	
414.320	0.400	110.48	0.0009	0.000	0.000	0.0009	
414.420	0.500	138.42	0.0009	0.000	0.000	0.0009	
414.520	0.600	165.09	0.0009	0.000	0.000	0.0009	
414.620	0.700	191.76	0.0009	0.000	0.000	0.0009	Top of Stone
414.720	0.800	191.83	0.0009	0.000	0.000	0.0009	Pipe Invert
414.820	0.900	191.90	0.0000	0.026	0.000	0.0264	
414.920	1.000	191.97	0.0000	0.037	0.000	0.0373	
415.020	1.100	192.04	0.0000	0.046	0.000	0.0457	
415.120	1.200	192.12	0.0000	0.053	0.000	0.0528	Top of Grate
415.220	1.300	201.40	0.0000	0.059	0.219	0.2777	
415.320	1.400	238.90	0.0000	0.065	0.629	0.6941	
415.420	1.500	304.65	0.0000	0.070	1.175	1.2444	
415.520	1.600	382.15	0.0000	0.075	1.834	1.9086	Overflow

**Ainley Farm Subdivision
Township of Centre Wellington (Elora)
G&M File: 411009
February 2019**

Catchment 1000 : Stormwater Management Facility No. 1

Stage Storage Volume Calculations

Elevation	Stage	Surface Area	Increm. Storage	Accum. Storage	
(m)	(m)	(m²)	(m³)	(m³)	
411.00	0.00	3,447	0	0.0	CB.1 Lip
411.10	0.10	5,051	425	424.9	
411.20	0.20	5,171	511	936.0	
411.30	0.30	5,291	523	1,459.1	
411.40	0.40	5,413	535	1,994.3	CB.2 Lip
411.50	0.50	5,535	547	2,541.7	
411.60	0.60	5,657	560	3,101.3	
411.70	0.70	5,781	572	3,673.2	
411.80	0.80	5,905	584	4,257.5	
411.85	0.85	5,968	297	4,554.3	Weir
412.00	1.00	6,156	909	5,463.6	Top of bank

Outlet #1

375 mm diameter pipe
300 mm orifice
Q = 0.197 m³/s
Cd = 0.600
H = 1.100 m
2g = 19.620

A = 0.071 m²
D = 0.300 m
D/2 = 0.150 m
Invert = 410.75

Outlet #2

450 mm diameter pipe
350 mm orifice
Q = 0.252 m³/s
Cd = 0.600
H = 0.975 m
2g = 19.620

A = 0.096 m²
D = 0.350 m
D/2 = 0.175 m
Invert = 410.85

Overflow Weir

Elevation = 411.90

d1 = 1.00 m
h = 0.85 m
H = 0.15 m
2g = 19.620
L = 20.00 m

Q = 1.638 m³/s

Ainley Farm Subdivision
Township of Centre Wellington (Elora)
G&M File: 411009
February 2019

Stage/Storage/Discharge Table

Elevation	Stage	Storage	Outlet #1	Outlet #2	Overflow	Actual	
(m)	(m)	(m³)	300 mm	450mm	Weir	Discharge	
			(m³/s)	(m³/s)	(m³/s)	(m³/s)	
411.00	0.00	0.0	0.000	0.000	0.000	0.000	CB.1 Lip
411.10	0.10	424.9	0.051	0.000	0.000	0.051	
411.20	0.20	936.0	0.103	0.000	0.000	0.103	
411.30	0.30	1,459.1	0.119	0.000	0.000	0.119	
411.40	0.40	1,994.3	0.133	0.000	0.000	0.133	CB.2 Lip
411.50	0.50	2,541.7	0.146	0.176	0.000	0.322	
411.60	0.60	3,101.3	0.157	0.194	0.000	0.351	
411.70	0.70	3,673.2	0.168	0.210	0.000	0.378	
411.80	0.80	4,257.5	0.178	0.225	0.000	0.403	
411.85	0.85	4,554.3	0.183	0.232	0.000	0.415	Weir
412.00	1.00	5,463.6	0.197	0.252	1.638	2.088	Top of bank

Ainley Farm Subdivision
Township of Centre Wellington (Elora)
G&M File: 411009
February 2019

Catchment 2100 : Stormwater Management Facility No. 2

Stage Storage Volume Calculations

Elevation	Stage	Surface Area	Increm. Storage	Accum. Storage	
(m)	(m)	(m²)	(m³)	(m³)	
410.65	0.00	488.80	0	0.0	Bottom of Pond/Knockout
410.70	0.05	511.10	25	25.0	
410.80	0.15	572.00	54	79.2	
410.90	0.25	634.70	60	139.5	
411.00	0.35	699.30	67	206.2	
411.10	0.45	765.60	73	279.4	
411.20	0.55	833.70	80	359.4	
411.30	0.65	903.60	87	446.3	CB Lip
411.40	0.75	975.23	94	540.2	
411.50	0.85	1048.80	101	641.4	
411.60	0.95	1124.10	109	750.1	
411.65	1.00	1150.00	57	806.9	Weir
411.95	1.30	1440.00	389	1,195.4	Top of bank

Outlet #1

120 mm Diameter Knockout

$$Q = 0.021 \text{ m}^3/\text{s}$$

$$Cd = 0.600$$

$$H = 0.490 \text{ m}$$

$$2g = 19.620$$

$$A = 0.011 \text{ m}^2$$

$$D = 0.120 \text{ m}$$

$$D/2 = 0.060 \text{ m}$$

Outlet #2

260 mm diameter orifice

$$Q = 0.156 \text{ m}^3/\text{s}$$

$$Cd = 0.600$$

$$H = 0.820 \text{ m}$$

$$2g = 19.620$$

$$A = 0.053 \text{ m}^2$$

$$D = 0.260 \text{ m}$$

$$D/2 = 0.130 \text{ m}$$

$$\text{Invert} = 410.60$$

Overflow Weir

Elevation = 411.65

$$d1 = 1.30 \text{ m}$$

$$h = 1.00 \text{ m}$$

$$H = 0.30 \text{ m}$$

$$2g = 19.62$$

$$L = 10.00 \text{ m}$$

$$Q = 2.369 \text{ m}^3/\text{s}$$

Stage/Storage/Discharge Table

Elevation	Stage	Storage	Outlet #1	Outlet #2	Overflow Weir	Actual Discharge	
(m)	(m)	(m³)	100 mm	425 mm	Weir	(m³/s)	
			(m³/s)	(m³/s)	(m³/s)		
410.65	0.00	0.0	0.000	0.000	0.000	0.000	Bottom of Pond/Knockout
410.70	0.05	25.0	0.005	0.000	0.000	0.005	
410.80	0.15	79.2	0.009	0.000	0.000	0.009	
410.90	0.25	139.5	0.013	0.000	0.000	0.013	
411.00	0.35	206.2	0.016	0.000	0.000	0.016	
411.10	0.45	279.4	0.019	0.000	0.000	0.019	
411.20	0.55	359.4	0.021	0.000	0.000	0.021	
411.30	0.65	446.3	0.023	0.000	0.000	0.023	CB Lip
411.40	0.75	540.2	0.000	0.115	0.000	0.115	
411.50	0.85	641.4	0.000	0.124	0.000	0.124	
411.60	0.95	750.1	0.000	0.132	0.000	0.132	
411.65	1.00	806.9	0.000	0.135	0.000	0.135	Weir
411.95	1.30	1,195.4	0.000	0.156	2.369	2.525	Top of bank

Ainley Farm Subdivision
Township of Centre Wellington (Elora)
G&M File: 411009
February 2019

Catchment 4000: Wetland

Stage Storage Volume Calculations

Elevation	Stage	Surface Area	Increm. Storage	Accum. Storage	
(m)	(m)	(m²)	(m³)	(m³)	
409.63	0.00	0	0	0.0	Wetland Bottom
409.75	0.12	3871	232	232.2	
410.00	0.37	10414	1786	2017.9	
410.25	0.62	14634	3131	5148.9	
410.50	0.87	19953	4323	9472.3	
410.75	1.12	24730	5585	15057.7	Overflow

WEIR CALCULATIONS

d1 = 1.12 m
h = 0.12 m
H = 1.00 m
2g = 19.62
L = 3 m

Q = 5.468 m³/s

Stage/Storage/Discharge Table

Elevation	Stage	Storage	Actual Discharge	
(m)	(m)	(m³)	(m³/s)	
409.63	0.00	0.0	0.000	Wetland Bottom
409.75	0.12	232.2	0.000	
410.00	0.37	2017.9	0.625	
410.25	0.62	5148.9	1.862	
410.50	0.87	9472.3	3.503	
410.75	1.12	15057.7	5.468	Overflow

```

"                                     Post__2yr
"                                     ----->"
" MIDUSS Output ----->"
" MIDUSS version                      Version 2.25 rev. 473"
" MIDUSS created                      Sunday, February 07, 2010"
" 10 Units used:                      ie METRIC"
" Job folder:                        w:\Kitchener\411-2011\411009\Design Data\
"                                     Modelling Files\2019-02-15"
" Output filename:                   Post__2yr.out"
" Licensee name:                     gmbp"
" Company                            Hewlett-Packard Company"
" Date & Time last used:             2/15/2019 at 2:43:26 PM"
" 31 TIME PARAMETERS"
" 5.000 Time Step"
" 180.000 Max. Storm length"
" 12000.000 Max. Hydrograph"
" 32 STORM Chicago storm"
" 1 Chicago storm"
" 695.047 Coefficient A"
" 6.387 Constant B"
" 0.793 Exponent C"
" 0.380 Fraction R"
" 180.000 Duration"
" 1.000 Time step multiplier"
" Maximum intensity                   93.292 mm/hr"
" Total depth                         33.014 mm"
" 6 002hyd Hydrograph extension used in this file"
" 33 CATCHMENT 1200"
" 1 Triangular SCS"
" 1 Equal length"
" 1 SCS method"
" 1200 Catchment 1200"
" 50.000 % Impervious"
" 0.220 Total Area"
" 10.000 Flow length"
" 2.000 Overland slope"
" 0.110 Pervious Area"
" 10.000 Pervious length"
" 2.000 Pervious slope"
" 0.110 Impervious Area"
" 10.000 Impervious length"
" 2.000 Impervious slope"
" 0.250 Pervious Manning 'n'"
" 78.000 Pervious SCS Curve No."
" 0.207 Pervious Runoff coefficient"
" 0.100 Pervious Ia/S coefficient"
" 7.164 Pervious Initial abstraction"
" 0.015 Impervious Manning 'n'"
" 98.000 Impervious SCS Curve No."
" 0.829 Impervious Runoff coefficient"
" 0.100 Impervious Ia/S coefficient"
" 0.518 Impervious Initial abstraction"
" 0.021 0.000 0.000 0.000 c.m/sec"
" Catchment 1200 Pervious Impervious Total Area "
" Surface Area 0.110 0.110 0.220 hectare"
" Time of concentration 13.484 1.233 3.680 minutes"
" Time to Centroid 116.839 87.775 93.582 minutes"
" Rainfall depth 33.014 33.014 33.014 mm"
" Rainfall volume 36.32 36.32 72.63 c.m"
" Rainfall losses 26.179 5.640 15.910 mm"
" Runoff depth 6.835 27.374 17.104 mm"
" Runoff volume 7.52 30.11 37.63 c.m"
" Runoff coefficient 0.207 0.829 0.518 "
" Maximum flow 0.003 0.021 0.021 c.m/sec"
" 40 HYDROGRAPH Add Runoff "

```



```

"          4  Add Runoff "
"          0.021  0.021  0.000  0.000"
" 33  CATCHMENT 1300"
"      1  Triangular SCS"
"      1  Equal length"
"      1  SCS method"
"      1300  Catchment 1300"
"      50.000  % Impervious"
"      0.840  Total Area"
"      20.000  Flow length"
"      2.000  Overland Slope"
"      0.420  Pervious Area"
"      20.000  Pervious length"
"      2.000  Pervious slope"
"      0.420  Impervious Area"
"      20.000  Impervious length"
"      2.000  Impervious slope"
"      0.250  Pervious Manning 'n'"
"      78.000  Pervious SCS Curve No."
"      0.207  Pervious Runoff coefficient"
"      0.100  Pervious Ia/S coefficient"
"      7.164  Pervious Initial abstraction"
"      0.015  Impervious Manning 'n'"
"      98.000  Impervious SCS Curve No."
"      0.838  Impervious Runoff coefficient"
"      0.100  Impervious Ia/S coefficient"
"      0.518  Impervious Initial abstraction"
"          0.076  0.021  0.000  0.000 c.m/sec"
"      Catchment 1300  Pervious  Impervious  Total Area  "
"      Surface Area  0.420  0.420  0.840  hectare"
"      Time of concentration  20.437  1.868  5.553  minutes"
"      Time to Centroid  125.085  88.659  95.887  minutes"
"      Rainfall depth  33.014  33.014  33.014  mm"
"      Rainfall volume  138.66  138.66  277.32  c.m"
"      Rainfall losses  26.169  5.363  15.766  mm"
"      Runoff depth  6.845  27.651  17.248  mm"
"      Runoff volume  28.75  116.13  144.88  c.m"
"      Runoff coefficient  0.207  0.838  0.522  "
"      Maximum flow  0.008  0.075  0.076  c.m/sec"
" 40  HYDROGRAPH Add Runoff "
"      4  Add Runoff "
"          0.076  0.097  0.000  0.000"
" 33  CATCHMENT 1600"
"      1  Triangular SCS"
"      1  Equal length"
"      1  SCS method"
"      1600  Catchment 1600"
"      50.000  % Impervious"
"      0.360  Total Area"
"      15.000  Flow length"
"      2.000  Overland Slope"
"      0.180  Pervious Area"
"      15.000  Pervious length"
"      2.000  Pervious slope"
"      0.180  Impervious Area"
"      15.000  Impervious length"
"      2.000  Impervious slope"
"      0.250  Pervious Manning 'n'"
"      78.000  Pervious SCS Curve No."
"      0.207  Pervious Runoff coefficient"
"      0.100  Pervious Ia/S coefficient"
"      7.164  Pervious Initial abstraction"
"      0.015  Impervious Manning 'n'"

```

```

"                                     Post__2yr
" 98.000 Impervious SCS Curve No."
" 0.836 Impervious Runoff coefficient"
" 0.100 Impervious Ia/S coefficient"
" 0.518 Impervious Initial abstraction"
"      0.033      0.097      0.000      0.000 c.m/sec"
" Catchment 1600 Pervious Impervious Total Area "
" Surface Area 0.180 0.180 0.360 hectare"
" Time of concentration 17.197 1.572 4.676 minutes"
" Time to Centroid 121.230 88.299 94.841 minutes"
" Rainfall depth 33.014 33.014 33.014 mm"
" Rainfall volume 59.42 59.42 118.85 c.m"
" Rainfall losses 26.170 5.407 15.789 mm"
" Runoff depth 6.844 27.606 17.225 mm"
" Runoff volume 12.32 49.69 62.01 c.m"
" Runoff coefficient 0.207 0.836 0.522 "
" Maximum flow 0.004 0.033 0.033 c.m/sec"
" 40 HYDROGRAPH Add Runoff "
" 4 Add Runoff "
"      0.033      0.130      0.000      0.000"
" 54 POND DESIGN"
" 0.130 Current peak flow c.m/sec"
" 0.250 Target outflow c.m/sec"
" 244.5 Hydrograph volume c.m"
" 16. Number of stages"
" 411.830 Minimum water level metre"
" 414.490 Maximum water level metre"
" 411.830 Starting water level metre"
" 0 Keep Design Data: 1 = True; 0 = False"
" Level Discharge Volume"
" 411.830 0.00033 0.000"
" 411.930 0.00033 19.920"
" 412.230 0.00034 143.570"
" 412.530 0.00035 267.220"
" 412.630 0.00035 287.130"
" 412.700 0.00035 301.070"
" 412.800 0.00035 301.140"
" 413.000 0.00035 301.260"
" 413.230 0.00035 301.400"
" 413.430 0.04510 301.740"
" 413.630 0.1310 302.400"
" 413.830 0.2461 303.400"
" 414.030 0.3862 304.740"
" 414.090 0.4327 305.240"
" 414.290 0.6461 307.240"
" 414.490 0.9189 309.570"
" Peak outflow 0.000 c.m/sec"
" Maximum level 412.465 metre"
" Maximum storage 240.501 c.m"
" Centroidal lag 100.901 hours"
"      0.033      0.130      0.000      0.000 c.m/sec"
" 40 HYDROGRAPH Combine 1"
" 6 Combine "
" 1 Node #"
" Outlets to SWMF No. 1"
" Maximum flow 0.000 c.m/sec"
" Hydrograph volume 236.400 c.m"
"      0.033      0.130      0.000      0.000"
" 40 HYDROGRAPH Start - New Tributary"
" 2 Start - New Tributary"
"      0.033      0.000      0.000      0.000"
" 33 CATCHMENT 1400"
" 1 Triangular SCS"
" 1 Equal length"

```

Post__2yr

```
"      1  SCS method"
"      1400 Catchment 1400"
"      20.000 % Impervious"
"      0.620 Total Area"
"      30.000 Flow length"
"      2.000 Overland Slope"
"      0.496 Pervious Area"
"      30.000 Pervious length"
"      2.000 Pervious slope"
"      0.124 Impervious Area"
"      30.000 Impervious length"
"      2.000 Impervious slope"
"      0.250 Pervious Manning 'n'"
"      78.000 Pervious SCS Curve No."
"      0.207 Pervious Runoff coefficient"
"      0.100 Pervious Ia/S coefficient"
"      7.164 Pervious Initial abstraction"
"      0.015 Impervious Manning 'n'"
"      98.000 Impervious SCS Curve No."
"      0.837 Impervious Runoff coefficient"
"      0.100 Impervious Ia/S coefficient"
"      0.518 Impervious Initial abstraction"
"      0.024 0.000 0.000 0.000 c.m/sec"
"      Catchment 1400 Pervious Impervious Total Area "
"      Surface Area 0.496 0.124 0.620 hectare"
"      Time of concentration 26.066 2.383 14.173 minutes"
"      Time to Centroid 131.779 89.515 110.556 minutes"
"      Rainfall depth 33.014 33.014 33.014 mm"
"      Rainfall volume 163.75 40.94 204.69 c.m"
"      Rainfall losses 26.167 5.389 22.011 mm"
"      Runoff depth 6.847 27.625 11.002 mm"
"      Runoff volume 33.96 34.25 68.22 c.m"
"      Runoff coefficient 0.207 0.837 0.333 "
"      Maximum flow 0.008 0.023 0.024 c.m/sec"
" 40 HYDROGRAPH Add Runoff "
"      4 Add Runoff "
"      0.024 0.024 0.000 0.000"
" 54 POND DESIGN"
"      0.024 Current peak flow c.m/sec"
"      0.250 Target outflow c.m/sec"
"      68.2 Hydrograph volume c.m"
"      17. Number of stages"
"      413.920 Minimum water level metre"
"      415.520 Maximum water level metre"
"      413.920 Starting water level metre"
"      0 Keep Design Data: 1 = True; 0 = False"
"      Level Discharge Volume"
"      413.920 0.00089 0.000"
"      414.020 0.00089 26.670"
"      414.120 0.00090 54.610"
"      414.220 0.00090 82.540"
"      414.320 0.00090 110.480"
"      414.420 0.00091 138.420"
"      414.520 0.00091 165.090"
"      414.620 0.00091 191.760"
"      414.720 0.00091 191.830"
"      414.820 0.02640 191.900"
"      414.920 0.03734 191.970"
"      415.020 0.04573 192.040"
"      415.120 0.05281 192.120"
"      415.220 0.2777 201.400"
"      415.320 0.6941 238.900"
"      415.420 1.244 304.650"
```

			Post__2yr			
"	415.520	1.909	382.150"			
"	Peak outflow		0.001	c.m/sec"		
"	Maximum level		414.120	metre"		
"	Maximum storage		54.655	c.m"		
"	Centroidal lag		13.440	hours"		
"	0.024	0.024	0.001	0.000	c.m/sec"	
40	HYDROGRAPH Next link "					
"	5 Next link "					
"	0.024	0.001	0.001	0.000"		
33	CATCHMENT 1500"					
"	1 Triangular SCS"					
"	1 Equal length"					
"	1 SCS method"					
"	1500 Catchment 1500"					
"	50.000 % Impervious"					
"	1.110 Total Area"					
"	40.000 Flow length"					
"	2.000 Overland Slope"					
"	0.555 Pervious Area"					
"	40.000 Pervious length"					
"	2.000 Pervious slope"					
"	0.555 Impervious Area"					
"	40.000 Impervious length"					
"	2.000 Impervious slope"					
"	0.250 Pervious Manning 'n'"					
"	78.000 Pervious SCS Curve No."					
"	0.207 Pervious Runoff coefficient"					
"	0.100 Pervious Ia/S coefficient"					
"	7.164 Pervious Initial abstraction"					
"	0.015 Impervious Manning 'n'"					
"	98.000 Impervious SCS Curve No."					
"	0.834 Impervious Runoff coefficient"					
"	0.100 Impervious Ia/S coefficient"					
"	0.518 Impervious Initial abstraction"					
"	0.105	0.001	0.001	0.000	c.m/sec"	
"	Catchment 1500	Pervious	Impervious	Total Area	"	
"	Surface Area	0.555	0.555	1.110	hectare"	
"	Time of concentration	30.977	2.832	8.436	minutes"	
"	Time to Centroid	137.612	90.217	99.655	minutes"	
"	Rainfall depth	33.014	33.014	33.014	mm"	
"	Rainfall volume	183.23	183.23	366.45	c.m"	
"	Rainfall losses	26.164	5.467	15.815	mm"	
"	Runoff depth	6.850	27.547	17.198	mm"	
"	Runoff volume	38.02	152.89	190.90	c.m"	
"	Runoff coefficient	0.207	0.834	0.521	"	
"	Maximum flow	0.008	0.104	0.105	c.m/sec"	
40	HYDROGRAPH Add Runoff "					
"	4 Add Runoff "					
"	0.105	0.106	0.001	0.000"		
56	DIVERSION"					
"	1500 Node number"					
"	0.146 Overflow threshold"					
"	1.000 Required diverted fraction"					
"	0 Conduit type; 1=Pipe;2=Channel"					
"	Peak of diverted flow	0.000		c.m/sec"		
"	Volume of diverted flow	0.000		c.m"		
"	DIV01500.002hyd"					
"	Major flow at 1500"					
"	0.105	0.106	0.106	0.000	c.m/sec"	
40	HYDROGRAPH Next link "					
"	5 Next link "					
"	0.105	0.106	0.106	0.000"		
33	CATCHMENT 1000"					

```

"      1 Triangular SCS"
"      1 Equal length"
"      1 SCS method"
"    1000 Catchment 1000"
"    50.000 % Impervious"
"     6.760 Total Area"
"   100.000 Flow length"
"     2.000 Overland Slope"
"     3.380 Pervious Area"
"   100.000 Pervious length"
"     2.000 Pervious slope"
"     3.380 Impervious Area"
"   100.000 Impervious length"
"     2.000 Impervious slope"
"     0.250 Pervious Manning 'n'"
"    78.000 Pervious SCS Curve No."
"     0.208 Pervious Runoff coefficient"
"     0.100 Pervious Ia/S coefficient"
"     7.164 Pervious Initial abstraction"
"     0.015 Impervious Manning 'n'"
"   98.000 Impervious SCS Curve No."
"     0.846 Impervious Runoff coefficient"
"     0.100 Impervious Ia/S coefficient"
"     0.518 Impervious Initial abstraction"
"           0.641     0.106     0.106     0.000 c.m/sec"
"   Catchment 1000      Pervious      Impervious      Total Area  "
"   Surface Area      3.380      3.380      6.760      hectare"
"   Time of concentration  53.679      4.907      14.516      minutes"
"   Time to Centroid      164.608      93.181      107.253      minutes"
"   Rainfall depth      33.014      33.014      33.014      mm"
"   Rainfall volume      1115.87      1115.87      2231.73      c.m"
"   Rainfall losses      26.162      5.089      15.626      mm"
"   Runoff depth      6.851      27.925      17.388      mm"
"   Runoff volume      231.58      943.87      1175.45      c.m"
"   Runoff coefficient      0.208      0.846      0.527      "
"   Maximum flow      0.035      0.638      0.641      c.m/sec"
" 40 HYDROGRAPH Add Runoff "
"     4 Add Runoff "
"           0.641     0.747     0.106     0.000"
" 33 CATCHMENT 1100"
"     1 Triangular SCS"
"     1 Equal length"
"     1 SCS method"
"    1100 Catchment 1100"
"     0.000 % Impervious"
"     0.480 Total Area"
"    20.000 Flow length"
"     2.000 Overland Slope"
"     0.480 Pervious Area"
"    20.000 Pervious length"
"     2.000 Pervious slope"
"     0.000 Impervious Area"
"    20.000 Impervious length"
"     2.000 Impervious slope"
"     0.250 Pervious Manning 'n'"
"    78.000 Pervious SCS Curve No."
"     0.207 Pervious Runoff coefficient"
"     0.100 Pervious Ia/S coefficient"
"     7.164 Pervious Initial abstraction"
"     0.015 Impervious Manning 'n'"
"   98.000 Impervious SCS Curve No."
"     0.000 Impervious Runoff coefficient"
"     0.100 Impervious Ia/S coefficient"

```

```

"          Post__2yr
" 0.518 Impervious Initial abstraction"
"          0.009      0.747      0.106      0.000 c.m/sec"
"          Catchment 1100 Pervious Impervious Total Area "
"          Surface Area      0.480      0.000      0.480      hectare"
"          Time of concentration 20.437      1.868      20.437      minutes"
"          Time to Centroid      125.085      88.659      125.085      minutes"
"          Rainfall depth      33.014      33.014      33.014      mm"
"          Rainfall volume      158.47      0.00      158.47      c.m"
"          Rainfall losses      26.169      5.363      26.169      mm"
"          Runoff depth      6.845      27.651      6.845      mm"
"          Runoff volume      32.86      0.00      32.86      c.m"
"          Runoff coefficient      0.207      0.000      0.207      "
"          Maximum flow      0.009      0.000      0.009      c.m/sec"
" 40 HYDROGRAPH Add Runoff "
" 4 Add Runoff "
"          0.009      0.750      0.106      0.000"
" 40 HYDROGRAPH Copy to Outflow"
" 8 Copy to Outflow"
"          0.009      0.750      0.750      0.000"
" 40 HYDROGRAPH Combine 1"
" 6 Combine "
" 1 Node #"
" Outlets to SWMF No. 1"
"          Maximum flow      0.750      c.m/sec"
"          Hydrograph volume      1703.822      c.m"
"          0.009      0.750      0.750      0.750"
" 40 HYDROGRAPH Confluence 1"
" 7 Confluence "
" 1 Node #"
" Outlets to SWMF No. 1"
"          Maximum flow      0.750      c.m/sec"
"          Hydrograph volume      1703.822      c.m"
"          0.009      0.750      0.750      0.000"
" 54 POND DESIGN"
" 0.750 Current peak flow      c.m/sec"
" 0.250 Target outflow      c.m/sec"
" 1703.8 Hydrograph volume      c.m"
" 11. Number of stages"
" 411.000 Minimum water level      metre"
" 412.000 Maximum water level      metre"
" 411.000 Starting water level      metre"
" 0 Keep Design Data: 1 = True; 0 = False"
" Level Discharge      volume"
" 411.000      0.000      0.000"
" 411.100      0.05100      425.000"
" 411.200      0.1030      936.000"
" 411.300      0.1190      1459.000"
" 411.400      0.1330      1994.000"
" 411.500      0.3220      2542.000"
" 411.600      0.3510      3101.000"
" 411.700      0.3780      3673.000"
" 411.800      0.4030      4258.000"
" 411.850      0.4150      4554.000"
" 412.000      2.088      5464.000"
" Peak outflow      0.089      c.m/sec"
" Maximum level      411.174      metre"
" Maximum storage      802.937      c.m"
" Centroidal lag      17.722      hours"
"          0.009      0.750      0.089      0.000 c.m/sec"
" 40 HYDROGRAPH Next link "
" 5 Next link "
"          0.009      0.089      0.089      0.000"
" 47 FILEI_0 Read/Open DIV01500.002hyd"

```

```

Post__2yr
" 1 1=read/open; 2=write/save"
" 2 1=rainfall; 2=hydrograph"
" 1 1=runoff; 2=inflow; 3=outflow; 4=junction"
" DIV01500.002hyd"
" Major flow at 1500"
" Total volume 0.000 c.m"
" Maximum flow 0.000 c.m/sec"
" 0.000 0.089 0.089 0.000 c.m/sec"
40 HYDROGRAPH Add Runoff "
" 4 Add Runoff "
" 0.000 0.089 0.089 0.000"
33 CATCHMENT 4000"
" 1 Triangular SCS"
" 1 Equal length"
" 1 SCS method"
" 4000 Catchment 4000"
" 0.000 % Impervious"
" 7.330 Total Area"
" 60.000 Flow length"
" 2.000 Overland Slope"
" 7.330 Pervious Area"
" 60.000 Pervious length"
" 2.000 Pervious slope"
" 0.000 Impervious Area"
" 60.000 Impervious length"
" 2.000 Impervious slope"
" 0.250 Pervious Manning 'n'"
" 50.000 Pervious SCS Curve No."
" 0.007 Pervious Runoff coefficient"
" 0.100 Pervious Ia/S coefficient"
" 25.400 Pervious Initial abstraction"
" 0.015 Impervious Manning 'n'"
" 98.000 Impervious SCS Curve No."
" 0.000 Impervious Runoff coefficient"
" 0.100 Impervious Ia/S coefficient"
" 0.518 Impervious Initial abstraction"
" 0.001 0.089 0.089 0.000 c.m/sec"
" Catchment 4000 Pervious Impervious Total Area "
" Surface Area 7.330 0.000 7.330 hectare"
" Time of concentration 236.857 3.611 236.829 minutes"
" Time to Centroid 321.153 91.497 321.125 minutes"
" Rainfall depth 33.014 33.014 33.014 mm"
" Rainfall volume 2419.91 0.00 2419.91 c.m"
" Rainfall losses 32.792 5.642 32.792 mm"
" Runoff depth 0.222 27.372 0.222 mm"
" Runoff volume 16.24 0.00 16.24 c.m"
" Runoff coefficient 0.007 0.000 0.007 "
" Maximum flow 0.001 0.000 0.001 c.m/sec"
40 HYDROGRAPH Add Runoff "
" 4 Add Runoff "
" 0.001 0.090 0.089 0.000"
54 POND DESIGN"
" 0.090 Current peak flow c.m/sec"
" 0.250 Target outflow c.m/sec"
" 1718.7 Hydrograph volume c.m"
" 6. Number of stages"
" 409.630 Minimum water level metre"
" 410.750 Maximum water level metre"
" 409.630 Starting water level metre"
" 0 Keep Design Data: 1 = True; 0 = False"
" Level Discharge Volume"
" 409.630 0.000 0.000"
" 409.750 0.6650 405.300"

```

```

"                                     Post__2yr
"          410.000      3.601  2191.000"
"          410.250      7.811  5322.000"
"          410.500     12.984  9645.400"
"          410.750     18.965 15230.80"
"          Peak outflow                    0.089   c.m/sec"
"          Maximum level                    409.646  metre"
"          Maximum storage                   54.277   c.m"
"          Centroidal lag                    17.775   hours"
"          0.001      0.090      0.089      0.000 c.m/sec"
" 40      HYDROGRAPH Next link "
"          5  Next link "
"          0.001      0.089      0.089      0.000"
" 52      CHANNEL DESIGN"
"          0.089  Current peak flow  c.m/sec"
"          0.035  Manning 'n'"
"          0.     Cross-section type: 0=trapezoidal; 1=general"
"          0.000  Basewidth  metre"
"          7.410  Left bank slope"
"          6.000  Right bank slope"
"          0.950  Channel depth  metre"
"          1.040  Gradient  %"
"          Depth of flow                    0.158   metre"
"          Velocity                         0.532   m/sec"
"          Channel capacity                  10.655  c.m/sec"
"          Critical depth                    0.129   metre"
" 53      ROUTE  Channel Route 72"
"          72.40  Channel Route 72 Reach length (metre)"
"          0.461  X-factor <= 0.5"
"          102.011 K-lag (seconds)"
"          0.000  Default(0) or user spec.(1) values used"
"          0.500  X-factor <= 0.5"
"          30.000  K-lag (seconds)"
"          0.500  Beta weighting factor"
"          100.000 Routing time step (seconds)"
"          1  No. of sub-reaches"
"          Peak outflow                    0.089   c.m/sec"
"          0.001      0.089      0.089      0.000 c.m/sec"
" 40      HYDROGRAPH Next link "
"          5  Next link "
"          0.001      0.089      0.089      0.000"
" 52      CHANNEL DESIGN"
"          0.089  Current peak flow  c.m/sec"
"          0.035  Manning 'n'"
"          0.     Cross-section type: 0=trapezoidal; 1=general"
"          2.000  Basewidth  metre"
"          2.950  Left bank slope"
"          3.000  Right bank slope"
"          0.950  Channel depth  metre"
"          1.040  Gradient  %"
"          Depth of flow                    0.080   metre"
"          Velocity                         0.500   m/sec"
"          Channel capacity                  9.246   c.m/sec"
"          Critical depth                    0.057   metre"
" 53      ROUTE  Channel Route 40"
"          39.80  Channel Route 40 Reach length (metre)"
"          0.444  X-factor <= 0.5"
"          59.654 K-lag (seconds)"
"          0.000  Default(0) or user spec.(1) values used"
"          0.500  X-factor <= 0.5"
"          30.000  K-lag (seconds)"
"          0.500  Beta weighting factor"
"          60.000 Routing time step (seconds)"
"          1  No. of sub-reaches"

```

		Post__2yr			
"	Peak outflow	0.089	0.089	0.089	c.m/sec"
"	0.001	0.089	0.089	0.000	c.m/sec"
" 40	HYDROGRAPH Combine	100"			
"	6 Combine "				
"	100 Node #"				
"	Existing wetland"				
"	Maximum flow	0.089			c.m/sec"
"	Hydrograph volume	1718.583			c.m"
"	0.001	0.089	0.089	0.089	0.089"
" 40	HYDROGRAPH Start - New Tributary"				
"	2 Start - New Tributary"				
"	0.001	0.000	0.089	0.089	0.089"
" 33	CATCHMENT 2100"				
"	1 Triangular SCS"				
"	1 Equal length"				
"	1 SCS method"				
"	2100 Catchment 2100"				
"	60.000 % Impervious"				
"	1.960 Total Area"				
"	40.000 Flow length"				
"	2.000 Overland Slope"				
"	0.784 Pervious Area"				
"	40.000 Pervious length"				
"	2.000 Pervious slope"				
"	1.176 Impervious Area"				
"	40.000 Impervious length"				
"	2.000 Impervious slope"				
"	0.250 Pervious Manning 'n'"				
"	78.000 Pervious SCS Curve No."				
"	0.207 Pervious Runoff coefficient"				
"	0.100 Pervious Ia/S coefficient"				
"	7.164 Pervious Initial abstraction"				
"	0.015 Impervious Manning 'n'"				
"	98.000 Impervious SCS Curve No."				
"	0.834 Impervious Runoff coefficient"				
"	0.100 Impervious Ia/S coefficient"				
"	0.518 Impervious Initial abstraction"				
"	0.223	0.000	0.089	0.089	c.m/sec"
"	Catchment 2100	Pervious	Impervious	Total Area	"
"	Surface Area	0.784	1.176	1.960	hectare"
"	Time of concentration	30.977	2.832	6.834	minutes"
"	Time to Centroid	137.612	90.217	96.956	minutes"
"	Rainfall depth	33.014	33.014	33.014	mm"
"	Rainfall volume	258.83	388.24	647.07	c.m"
"	Rainfall losses	26.164	5.467	13.746	mm"
"	Runoff depth	6.850	27.547	19.268	mm"
"	Runoff volume	53.70	323.95	377.66	c.m"
"	Runoff coefficient	0.207	0.834	0.584	"
"	Maximum flow	0.012	0.221	0.223	c.m/sec"
" 40	HYDROGRAPH Add Runoff "				
"	4 Add Runoff "				
"	0.223	0.223	0.089	0.089	0.089"
" 33	CATCHMENT 2400"				
"	1 Triangular SCS"				
"	1 Equal length"				
"	1 SCS method"				
"	2400 Catchment 2400"				
"	90.000 % Impervious"				
"	0.790 Total Area"				
"	20.000 Flow length"				
"	2.000 Overland Slope"				
"	0.079 Pervious Area"				
"	20.000 Pervious length"				

```

Post__2yr
"      2.000 Pervious slope"
"      0.711 Impervious Area"
"     20.000 Impervious length"
"      2.000 Impervious slope"
"      0.250 Pervious Manning 'n'"
"     78.000 Pervious SCS Curve No."
"      0.207 Pervious Runoff coefficient"
"      0.100 Pervious Ia/S coefficient"
"      7.164 Pervious Initial abstraction"
"      0.015 Impervious Manning 'n'"
"     98.000 Impervious SCS Curve No."
"      0.838 Impervious Runoff coefficient"
"      0.100 Impervious Ia/S coefficient"
"      0.518 Impervious Initial abstraction"
"          0.127      0.223      0.089      0.089 c.m/sec"
"      Catchment 2400 Pervious Impervious Total Area "
"      Surface Area      0.079      0.711      0.790 hectare"
"      Time of concentration 20.437      1.868      2.365 minutes"
"      Time to Centroid 125.085      88.659      89.634 minutes"
"      Rainfall depth 33.014      33.014      33.014 mm"
"      Rainfall volume 26.08      234.73      260.81 c.m"
"      Rainfall losses 26.169      5.363      7.444 mm"
"      Runoff depth 6.845      27.651      25.570 mm"
"      Runoff volume 5.41      196.60      202.00 c.m"
"      Runoff coefficient 0.207      0.838      0.775 "
"      Maximum flow 0.002      0.127      0.127 c.m/sec"
40 HYDROGRAPH Add Runoff "
"      4 Add Runoff "
"          0.127      0.347      0.089      0.089"
54 POND DESIGN"
"      0.347 Current peak flow c.m/sec"
"      0.020 Target outflow c.m/sec"
"     579.7 Hydrograph volume c.m"
"      13. Number of stages"
"     410.650 Minimum water level metre"
"     411.950 Maximum water level metre"
"     410.650 Starting water level metre"
"      0 Keep Design Data: 1 = True; 0 = False"
"          Level Discharge Volume"
"     410.650      0.000      0.000"
"     410.700      0.00600      42.000"
"     410.800      0.01300      130.000"
"     410.900      0.02000      225.000"
"     411.000      0.02500      328.000"
"     411.100      0.02900      439.000"
"     411.200      0.1260      558.000"
"     411.300      0.1390      686.000"
"     411.400      0.1510      822.000"
"     411.500      0.1630      967.000"
"     411.600      0.1730      1121.000"
"     411.650      0.1780      1202.000"
"     411.950      2.575      1742.000"
"      Peak outflow      0.027 c.m/sec"
"      Maximum level 411.062 metre"
"      Maximum storage 397.232 c.m"
"      Centroidal lag 4.834 hours"
"          0.127      0.347      0.027      0.089 c.m/sec"
40 HYDROGRAPH Next link "
"      5 Next link "
"          0.127      0.027      0.027      0.089"
33 CATCHMENT 2300"
"      1 Triangular SCS"
"      1 Equal length"

```

```

"      1 SCS method"
"      2300 Catchment 2300"
"     10.000 % Impervious"
"      0.480 Total Area"
"     20.000 Flow length"
"      2.000 Overland Slope"
"      0.432 Pervious Area"
"     20.000 Pervious length"
"      2.000 Pervious slope"
"      0.048 Impervious Area"
"     20.000 Impervious length"
"      2.000 Impervious slope"
"      0.250 Pervious Manning 'n'"
"     78.000 Pervious SCS Curve No."
"      0.207 Pervious Runoff coefficient"
"      0.100 Pervious Ia/S coefficient"
"      7.164 Pervious Initial abstraction"
"      0.015 Impervious Manning 'n'"
"     98.000 Impervious SCS Curve No."
"      0.838 Impervious Runoff coefficient"
"      0.100 Impervious Ia/S coefficient"
"      0.518 Impervious Initial abstraction"
"          0.011      0.027      0.027      0.089 c.m/sec"
"      Catchment 2300      Pervious      Impervious      Total Area      "
"      Surface Area      0.432      0.048      0.480      hectare"
"      Time of concentration      20.437      1.868      14.685      minutes"
"      Time to Centroid      125.085      88.659      113.801      minutes"
"      Rainfall depth      33.014      33.014      33.014      mm"
"      Rainfall volume      142.62      15.85      158.47      c.m"
"      Rainfall losses      26.169      5.363      24.088      mm"
"      Runoff depth      6.845      27.651      8.926      mm"
"      Runoff volume      29.57      13.27      42.84      c.m"
"      Runoff coefficient      0.207      0.838      0.270      "
"      Maximum flow      0.008      0.009      0.011      c.m/sec"
" 40      HYDROGRAPH Add Runoff "
"      4      Add Runoff "
"          0.011      0.036      0.027      0.089"
" 40      HYDROGRAPH Copy to Outflow"
"      8      Copy to Outflow"
"          0.011      0.036      0.036      0.089"
" 40      HYDROGRAPH Combine 200"
"      6      Combine "
"     200      Node #"
"          To Trib. of Grand River"
"          Maximum flow      0.036      c.m/sec"
"          Hydrograph volume      622.521      c.m"
"          0.011      0.036      0.036      0.036"
" 40      HYDROGRAPH Start - New Tributary"
"      2      Start - New Tributary"
"          0.011      0.000      0.036      0.036"
" 33      CATCHMENT 2200"
"      1      Triangular SCS"
"      1      Equal length"
"      1      SCS method"
"     2200      Catchment 2200"
"     75.000      % Impervious"
"      0.920      Total Area"
"     40.000      Flow length"
"      2.000      Overland Slope"
"      0.230      Pervious Area"
"     40.000      Pervious length"
"      2.000      Pervious slope"
"      0.690      Impervious Area"

```

```

Post__2yr
" 40.000 Impervious length"
" 2.000 Impervious slope"
" 0.250 Pervious Manning 'n'"
" 78.000 Pervious SCS Curve No."
" 0.207 Pervious Runoff coefficient"
" 0.100 Pervious Ia/S coefficient"
" 7.164 Pervious Initial abstraction"
" 0.015 Impervious Manning 'n'"
" 98.000 Impervious SCS Curve No."
" 0.834 Impervious Runoff coefficient"
" 0.100 Impervious Ia/S coefficient"
" 0.518 Impervious Initial abstraction"
" 0.130 0.000 0.036 0.036 c.m/sec"
" Catchment 2200 Pervious Impervious Total Area "
" Surface Area 0.230 0.690 0.920 hectare"
" Time of concentration 30.977 2.832 4.986 minutes"
" Time to Centroid 137.612 90.217 93.844 minutes"
" Rainfall depth 33.014 33.014 33.014 mm"
" Rainfall volume 75.93 227.80 303.73 c.m"
" Rainfall losses 26.164 5.467 10.641 mm"
" Runoff depth 6.850 27.547 22.373 mm"
" Runoff volume 15.75 190.08 205.83 c.m"
" Runoff coefficient 0.207 0.834 0.678 "
" Maximum flow 0.004 0.129 0.130 c.m/sec"
" 40 HYDROGRAPH Add Runoff "
" 4 Add Runoff "
" 0.130 0.130 0.036 0.036"
" 54 POND DESIGN"
" 0.130 Current peak flow c.m/sec"
" 0.756 Target outflow c.m/sec"
" 205.8 Hydrograph volume c.m"
" 12. Number of stages"
" 413.700 Minimum water level metre"
" 415.000 Maximum water level metre"
" 413.700 Starting water level metre"
" 0 Keep Design Data: 1 = True; 0 = False"
" Level Discharge volume"
" 413.700 0.000 0.000"
" 413.800 0.00500 88.600"
" 413.900 0.01000 187.200"
" 414.000 0.01300 298.400"
" 414.100 0.01500 422.200"
" 414.200 0.2220 558.900"
" 414.300 0.2590 708.500"
" 414.400 0.2910 871.100"
" 414.500 0.3210 1046.900"
" 414.600 0.3470 1236.100"
" 414.700 0.3720 1438.700"
" 415.000 2.808 2087.400"
" Peak outflow 0.008 c.m/sec"
" Maximum level 413.864 metre"
" Maximum storage 151.519 c.m"
" Centroidal lag 6.574 hours"
" 0.130 0.130 0.008 0.036 c.m/sec"
" 40 HYDROGRAPH Combine 200"
" 6 Combine "
" 200 Node #"
" To Trib. of Grand River"
" Maximum flow 0.043 c.m/sec"
" Hydrograph volume 828.346 c.m"
" 0.130 0.130 0.008 0.043"
" 40 HYDROGRAPH Start - New Tributary"
" 2 Start - New Tributary"

```

```

"          0.130      0.000      Post__2yr      0.008      0.043"
" 33      CATCHMENT 3200"
"          1      Triangular SCS"
"          1      Equal length"
"          1      SCS method"
"          3200      Catchment 3200"
"          60.000      % Impervious"
"          0.530      Total Area"
"          40.000      Flow length"
"          1.000      Overland Slope"
"          0.212      Pervious Area"
"          40.000      Pervious length"
"          1.000      Pervious slope"
"          0.318      Impervious Area"
"          40.000      Impervious length"
"          1.000      Impervious slope"
"          0.250      Pervious Manning 'n'"
"          78.000      Pervious SCS Curve No."
"          0.208      Pervious Runoff coefficient"
"          0.100      Pervious Ia/S coefficient"
"          7.164      Pervious Initial abstraction"
"          0.015      Impervious Manning 'n'"
"          98.000      Impervious SCS Curve No."
"          0.830      Impervious Runoff coefficient"
"          0.100      Impervious Ia/S coefficient"
"          0.518      Impervious Initial abstraction"
"          0.061      0.000      0.008      0.043 c.m/sec"
"          Catchment 3200      Pervious      Impervious      Total Area      "
"          Surface Area      0.212      0.318      0.530      hectare"
"          Time of concentration      38.137      3.486      8.435      minutes"
"          Time to Centroid      146.130      91.278      99.112      minutes"
"          Rainfall depth      33.014      33.014      33.014      mm"
"          Rainfall volume      69.99      104.98      174.97      c.m"
"          Rainfall losses      26.163      5.605      13.828      mm"
"          Runoff depth      6.851      27.409      19.185      mm"
"          Runoff volume      14.52      87.16      101.68      c.m"
"          Runoff coefficient      0.208      0.830      0.581      "
"          Maximum flow      0.003      0.061      0.061      c.m/sec"
" 40      HYDROGRAPH Add Runoff "
"          4      Add Runoff "
"          0.061      0.061      0.008      0.043"
" 33      CATCHMENT 3300"
"          1      Triangular SCS"
"          1      Equal length"
"          1      SCS method"
"          3300      Catchment 3300"
"          60.000      % Impervious"
"          0.240      Total Area"
"          20.000      Flow length"
"          2.000      Overland Slope"
"          0.096      Pervious Area"
"          20.000      Pervious length"
"          2.000      Pervious slope"
"          0.144      Impervious Area"
"          20.000      Impervious length"
"          2.000      Impervious slope"
"          0.250      Pervious Manning 'n'"
"          78.000      Pervious SCS Curve No."
"          0.207      Pervious Runoff coefficient"
"          0.100      Pervious Ia/S coefficient"
"          7.164      Pervious Initial abstraction"
"          0.015      Impervious Manning 'n'"
"          98.000      Impervious SCS Curve No."

```

			Post_2yr		
"	0.838	Impervious Runoff coefficient"			
"	0.100	Impervious Ia/S coefficient"			
"	0.518	Impervious Initial abstraction"			
"		0.026	0.061	0.008	0.043 c.m/sec"
"		Catchment 3300	Pervious	Impervious	Total Area "
"		Surface Area	0.096	0.144	0.240 hectare"
"		Time of concentration	20.437	1.868	4.499 minutes"
"		Time to Centroid	125.085	88.659	93.819 minutes"
"		Rainfall depth	33.014	33.014	33.014 mm"
"		Rainfall volume	31.69	47.54	79.23 c.m"
"		Rainfall losses	26.169	5.363	13.685 mm"
"		Runoff depth	6.845	27.651	19.329 mm"
"		Runoff volume	6.57	39.82	46.39 c.m"
"		Runoff coefficient	0.207	0.838	0.585 "
"		Maximum flow	0.002	0.026	0.026 c.m/sec"
" 40		HYDROGRAPH Add Runoff "			
"	4	Add Runoff "			
"		0.026	0.087	0.008	0.043"
" 40		HYDROGRAPH Copy to Outflow"			
"	8	Copy to Outflow"			
"		0.026	0.087	0.087	0.043"
" 40		HYDROGRAPH Combine 300"			
"	6	Combine "			
"	300	Node #"			
"		To Walser Street"			
"		Maximum flow	0.087		c.m/sec"
"		Hydrograph volume	148.072		c.m"
"		0.026	0.087	0.087	0.087"
" 40		HYDROGRAPH Confluence 300"			
"	7	Confluence "			
"	300	Node #"			
"		To Walser Street"			
"		Maximum flow	0.087		c.m/sec"
"		Hydrograph volume	148.072		c.m"
"		0.026	0.087	0.087	0.000"
" 40		HYDROGRAPH Copy to Outflow"			
"	8	Copy to Outflow"			
"		0.026	0.087	0.087	0.000"
" 40		HYDROGRAPH Combine 100"			
"	6	Combine "			
"	100	Node #"			
"		Existing wetland"			
"		Maximum flow	0.098		c.m/sec"
"		Hydrograph volume	1866.656		c.m"
"		0.026	0.087	0.087	0.098"
" 40		HYDROGRAPH Confluence 100"			
"	7	Confluence "			
"	100	Node #"			
"		Existing wetland"			
"		Maximum flow	0.098		c.m/sec"
"		Hydrograph volume	1866.656		c.m"
"		0.026	0.098	0.087	0.000"
" 40		HYDROGRAPH Copy to Outflow"			
"	8	Copy to Outflow"			
"		0.026	0.098	0.098	0.000"
" 40		HYDROGRAPH Combine 200"			
"	6	Combine "			
"	200	Node #"			
"		To Trib. of Grand River"			
"		Maximum flow	0.135		c.m/sec"
"		Hydrograph volume	2695.002		c.m"
"		0.026	0.098	0.098	0.135"
" 40		HYDROGRAPH Confluence 200"			

"			Post__2yr			
"	7	Confluence "				
"	200	Node #"				
"		To Trib. of Grand River"				
"		Maximum flow	0.135		c.m/sec"	
"		Hydrograph volume	2695.002		c.m"	
"		0.026	0.135	0.098	0.000"	
" 38		START/RE-START TOTALS 200"				
"	3	Runoff Totals on EXIT"				
"		Total Catchment area		22.640	hectare"	
"		Total Impervious area		7.856	hectare"	
"		Total % impervious		34.700"		
" 19		EXIT"				

```

"                                     Post__5yr
"                                     ----->"
"      MIDUSS Output ----->"
"      MIDUSS version                      Version 2.25 rev. 473"
"      MIDUSS created                      Sunday, February 07, 2010"
"      10  Units used:                      ie METRIC"
"      Job folder:                        w:\Kitchener\411-2011\411009\Design Data\
"                                     Modelling Files\2019-02-15"
"      Output filename:                    Post__5yr.out"
"      Licensee name:                      gmbp"
"      Company                            Hewlett-Packard Company"
"      Date & Time last used:              2/15/2019 at 2:45:23 PM"
" 31  TIME PARAMETERS"
"      5.000  Time Step"
"      180.000 Max. Storm length"
"      12000.000 Max. Hydrograph"
" 32  STORM Chicago storm"
"      1  Chicago storm"
"      1459.072 Coefficient A"
"      13.690  Constant B"
"      0.850  Exponent C"
"      0.380  Fraction R"
"      180.000 Duration"
"      1.000  Time step multiplier"
"      Maximum intensity                    113.586  mm/hr"
"      Total depth                          49.792  mm"
"      6  005hyd  Hydrograph extension used in this file"
" 33  CATCHMENT 1200"
"      1  Triangular SCS"
"      1  Equal length"
"      1  SCS method"
"      1200  Catchment 1200"
"      50.000 % Impervious"
"      0.220  Total Area"
"      10.000 Flow length"
"      2.000  Overland slope"
"      0.110  Pervious Area"
"      10.000 Pervious length"
"      2.000  Pervious slope"
"      0.110  Impervious Area"
"      10.000 Impervious length"
"      2.000  Impervious slope"
"      0.250  Pervious Manning 'n'"
"      78.000 Pervious SCS Curve No."
"      0.317  Pervious Runoff coefficient"
"      0.100  Pervious Ia/S coefficient"
"      7.164  Pervious Initial abstraction"
"      0.015  Impervious Manning 'n'"
"      98.000 Impervious SCS Curve No."
"      0.871  Impervious Runoff coefficient"
"      0.100  Impervious Ia/S coefficient"
"      0.518  Impervious Initial abstraction"
"      0.029  0.000  0.000  0.000 c.m/sec"
"      Catchment 1200  Pervious  Impervious  Total Area  "
"      Surface Area    0.110    0.110    0.220    hectare"
"      Time of concentration  9.868    1.116    3.453    minutes"
"      Time to Centroid    109.069  86.405    92.457    minutes"
"      Rainfall depth    49.792    49.792    49.792    mm"
"      Rainfall volume    54.77    54.77    109.54    c.m"
"      Rainfall losses    33.989    6.414    20.202    mm"
"      Runoff depth      15.803    43.377    29.590    mm"
"      Runoff volume     17.38    47.72    65.10    c.m"
"      Runoff coefficient  0.317    0.871    0.594    "
"      Maximum flow      0.007    0.028    0.029    c.m/sec"
" 40  HYDROGRAPH Add Runoff "

```



```

"          4  Add Runoff "
"          0.029  0.029  0.000  0.000"
" 33  CATCHMENT 1300"
"      1  Triangular SCS"
"      1  Equal length"
"      1  SCS method"
"      1300  Catchment 1300"
"      50.000  % Impervious"
"      0.840  Total Area"
"      20.000  Flow length"
"      2.000  Overland Slope"
"      0.420  Pervious Area"
"      20.000  Pervious length"
"      2.000  Pervious slope"
"      0.420  Impervious Area"
"      20.000  Impervious length"
"      2.000  Impervious slope"
"      0.250  Pervious Manning 'n'"
"      78.000  Pervious SCS Curve No."
"      0.319  Pervious Runoff coefficient"
"      0.100  Pervious Ia/S coefficient"
"      7.164  Pervious Initial abstraction"
"      0.015  Impervious Manning 'n'"
"      98.000  Impervious SCS Curve No."
"      0.883  Impervious Runoff coefficient"
"      0.100  Impervious Ia/S coefficient"
"      0.518  Impervious Initial abstraction"
"          0.111  0.029  0.000  0.000 c.m/sec"
"      Catchment 1300  Pervious  Impervious  Total Area  "
"      Surface Area  0.420  0.420  0.840  hectare"
"      Time of concentration  14.957  1.691  5.209  minutes"
"      Time to Centroid  115.000  87.210  94.579  minutes"
"      Rainfall depth  49.792  49.792  49.792  mm"
"      Rainfall volume  209.13  209.13  418.25  c.m"
"      Rainfall losses  33.921  5.811  19.866  mm"
"      Runoff depth  15.871  43.981  29.926  mm"
"      Runoff volume  66.66  184.72  251.38  c.m"
"      Runoff coefficient  0.319  0.883  0.601  "
"      Maximum flow  0.025  0.103  0.111  c.m/sec"
" 40  HYDROGRAPH Add Runoff "
"      4  Add Runoff "
"          0.111  0.141  0.000  0.000"
" 33  CATCHMENT 1600"
"      1  Triangular SCS"
"      1  Equal length"
"      1  SCS method"
"      1600  Catchment 1600"
"      50.000  % Impervious"
"      0.360  Total Area"
"      15.000  Flow length"
"      2.000  Overland Slope"
"      0.180  Pervious Area"
"      15.000  Pervious length"
"      2.000  Pervious slope"
"      0.180  Impervious Area"
"      15.000  Impervious length"
"      2.000  Impervious slope"
"      0.250  Pervious Manning 'n'"
"      78.000  Pervious SCS Curve No."
"      0.318  Pervious Runoff coefficient"
"      0.100  Pervious Ia/S coefficient"
"      7.164  Pervious Initial abstraction"
"      0.015  Impervious Manning 'n'"

```

```

Post__5yr
" 98.000 Impervious SCS Curve No."
" 0.881 Impervious Runoff coefficient"
" 0.100 Impervious Ia/S coefficient"
" 0.518 Impervious Initial abstraction"
" 0.048 0.141 0.000 0.000 c.m/sec"
" Catchment 1600 Pervious Impervious Total Area "
" Surface Area 0.180 0.180 0.360 hectare"
" Time of concentration 12.585 1.423 4.386 minutes"
" Time to Centroid 112.243 86.878 93.610 minutes"
" Rainfall depth 49.792 49.792 49.792 mm"
" Rainfall volume 89.63 89.63 179.25 c.m"
" Rainfall losses 33.944 5.926 19.935 mm"
" Runoff depth 15.848 43.866 29.857 mm"
" Runoff volume 28.53 78.96 107.49 c.m"
" Runoff coefficient 0.318 0.881 0.600 "
" Maximum flow 0.011 0.045 0.048 c.m/sec"
" 40 HYDROGRAPH Add Runoff "
" 4 Add Runoff "
" 0.048 0.189 0.000 0.000"
" 54 POND DESIGN"
" 0.189 Current peak flow c.m/sec"
" 0.250 Target outflow c.m/sec"
" 424.0 Hydrograph volume c.m"
" 16. Number of stages"
" 411.830 Minimum water level metre"
" 414.490 Maximum water level metre"
" 411.830 Starting water level metre"
" 0 Keep Design Data: 1 = True; 0 = False"
" Level Discharge Volume"
" 411.830 0.00033 0.000"
" 411.930 0.00033 19.920"
" 412.230 0.00034 143.570"
" 412.530 0.00035 267.220"
" 412.630 0.00035 287.130"
" 412.700 0.00035 301.070"
" 412.800 0.00035 301.140"
" 413.000 0.00035 301.260"
" 413.230 0.00035 301.400"
" 413.430 0.04510 301.740"
" 413.630 0.1310 302.400"
" 413.830 0.2461 303.400"
" 414.030 0.3862 304.740"
" 414.090 0.4327 305.240"
" 414.290 0.6461 307.240"
" 414.490 0.9189 309.570"
" Peak outflow 0.045 c.m/sec"
" Maximum level 413.445 metre"
" Maximum storage 301.791 c.m"
" Centroidal lag 93.389 hours"
" 0.048 0.189 0.045 0.000 c.m/sec"
" 40 HYDROGRAPH Combine 1"
" 6 Combine "
" 1 Node #"
" Outlets to SWMF No. 1"
" Maximum flow 0.045 c.m/sec"
" Hydrograph volume 360.765 c.m"
" 0.048 0.189 0.045 0.045"
" 40 HYDROGRAPH Start - New Tributary"
" 2 Start - New Tributary"
" 0.048 0.000 0.045 0.045"
" 33 CATCHMENT 1400"
" 1 Triangular SCS"
" 1 Equal length"

```

Post__5yr

```

"      1  SCS method"
"      1400 Catchment 1400"
"      20.000 % Impervious"
"      0.620 Total Area"
"      30.000 Flow length"
"      2.000 Overland Slope"
"      0.496 Pervious Area"
"      30.000 Pervious length"
"      2.000 Pervious slope"
"      0.124 Impervious Area"
"      30.000 Impervious length"
"      2.000 Impervious slope"
"      0.250 Pervious Manning 'n'"
"      78.000 Pervious SCS Curve No."
"      0.319 Pervious Runoff coefficient"
"      0.100 Pervious Ia/S coefficient"
"      7.164 Pervious Initial abstraction"
"      0.015 Impervious Manning 'n'"
"      98.000 Impervious SCS Curve No."
"      0.882 Impervious Runoff coefficient"
"      0.100 Impervious Ia/S coefficient"
"      0.518 Impervious Initial abstraction"
"      0.038 0.000 0.045 0.045 c.m/sec"
"      Catchment 1400 Pervious Impervious Total Area "
"      Surface Area 0.496 0.124 0.620 hectare"
"      Time of concentration 19.076 2.157 12.156 minutes"
"      Time to Centroid 119.796 87.903 106.752 minutes"
"      Rainfall depth 49.792 49.792 49.792 mm"
"      Rainfall volume 246.97 61.74 308.71 c.m"
"      Rainfall losses 33.923 5.866 28.312 mm"
"      Runoff depth 15.868 43.926 21.480 mm"
"      Runoff volume 78.71 54.47 133.17 c.m"
"      Runoff coefficient 0.319 0.882 0.431 "
"      Maximum flow 0.025 0.031 0.038 c.m/sec"
" 40 HYDROGRAPH Add Runoff "
"      4 Add Runoff "
"      0.038 0.038 0.045 0.045"
" 54 POND DESIGN"
"      0.038 Current peak flow c.m/sec"
"      0.250 Target outflow c.m/sec"
"      133.2 Hydrograph volume c.m"
"      17. Number of stages"
"      413.920 Minimum water level metre"
"      415.520 Maximum water level metre"
"      413.920 Starting water level metre"
"      0 Keep Design Data: 1 = True; 0 = False"
"      Level Discharge Volume"
"      413.920 0.00089 0.000"
"      414.020 0.00089 26.670"
"      414.120 0.00090 54.610"
"      414.220 0.00090 82.540"
"      414.320 0.00090 110.480"
"      414.420 0.00091 138.420"
"      414.520 0.00091 165.090"
"      414.620 0.00091 191.760"
"      414.720 0.00091 191.830"
"      414.820 0.02640 191.900"
"      414.920 0.03734 191.970"
"      415.020 0.04573 192.040"
"      415.120 0.05281 192.120"
"      415.220 0.2777 201.400"
"      415.320 0.6941 238.900"
"      415.420 1.244 304.650"

```

			Post__5yr		
"	415.520	1.909	382.150"		
"	Peak outflow		0.001	c.m/sec"	
"	Maximum level		414.367	metre"	
"	Maximum storage		123.517	c.m"	
"	Centroidal lag		22.519	hours"	
"	0.038	0.038	0.001	0.045	c.m/sec"
40	HYDROGRAPH Next link "				
"	5 Next link "				
"	0.038	0.001	0.001	0.045"	
33	CATCHMENT 1500"				
"	1 Triangular SCS"				
"	1 Equal length"				
"	1 SCS method"				
"	1500 Catchment 1500"				
"	50.000 % Impervious"				
"	1.110 Total Area"				
"	40.000 Flow length"				
"	2.000 Overland Slope"				
"	0.555 Pervious Area"				
"	40.000 Pervious length"				
"	2.000 Pervious slope"				
"	0.555 Impervious Area"				
"	40.000 Impervious length"				
"	2.000 Impervious slope"				
"	0.250 Pervious Manning 'n'"				
"	78.000 Pervious SCS Curve No."				
"	0.319 Pervious Runoff coefficient"				
"	0.100 Pervious Ia/S coefficient"				
"	7.164 Pervious Initial abstraction"				
"	0.015 Impervious Manning 'n'"				
"	98.000 Impervious SCS Curve No."				
"	0.878 Impervious Runoff coefficient"				
"	0.100 Impervious Ia/S coefficient"				
"	0.518 Impervious Initial abstraction"				
"	0.146	0.001	0.001	0.045	c.m/sec"
"	Catchment 1500	Pervious	Impervious	Total Area	"
"	Surface Area	0.555	0.555	1.110	hectare"
"	Time of concentration	22.670	2.563	7.922	minutes"
"	Time to Centroid	124.006	88.517	97.975	minutes"
"	Rainfall depth	49.792	49.792	49.792	mm"
"	Rainfall volume	276.34	276.34	552.69	c.m"
"	Rainfall losses	33.904	6.066	19.985	mm"
"	Runoff depth	15.888	43.726	29.807	mm"
"	Runoff volume	88.18	242.68	330.86	c.m"
"	Runoff coefficient	0.319	0.878	0.599	"
"	Maximum flow	0.026	0.139	0.146	c.m/sec"
40	HYDROGRAPH Add Runoff "				
"	4 Add Runoff "				
"	0.146	0.146	0.001	0.045"	
56	DIVERSION"				
"	1500 Node number"				
"	0.146 Overflow threshold"				
"	1.000 Required diverted fraction"				
"	0 Conduit type; 1=Pipe;2=Channel"				
"	Peak of diverted flow		0.000	c.m/sec"	
"	Volume of diverted flow		0.104	c.m"	
"	DIV01500.005hyd"				
"	Major flow at 1500"				
"	0.146	0.146	0.146	0.045	c.m/sec"
40	HYDROGRAPH Next link "				
"	5 Next link "				
"	0.146	0.146	0.146	0.045"	
33	CATCHMENT 1000"				

```

"      1 Triangular SCS"
"      1 Equal length"
"      1 SCS method"
"    1000 Catchment 1000"
"    50.000 % Impervious"
"     6.760 Total Area"
"   100.000 Flow length"
"     2.000 Overland Slope"
"     3.380 Pervious Area"
"   100.000 Pervious length"
"     2.000 Pervious slope"
"     3.380 Impervious Area"
"   100.000 Impervious length"
"     2.000 Impervious slope"
"     0.250 Pervious Manning 'n'"
"    78.000 Pervious SCS Curve No."
"     0.319 Pervious Runoff coefficient"
"     0.100 Pervious Ia/S coefficient"
"     7.164 Pervious Initial abstraction"
"     0.015 Impervious Manning 'n'"
"   98.000 Impervious SCS Curve No."
"     0.888 Impervious Runoff coefficient"
"     0.100 Impervious Ia/S coefficient"
"     0.518 Impervious Initial abstraction"
"           0.905      0.146      0.146      0.045 c.m/sec"
"   Catchment 1000      Pervious      Impervious      Total Area  "
"   Surface Area      3.380      3.380      6.760      hectare"
"   Time of concentration 39.284      4.442      13.658      minutes"
"   Time to Centroid      143.413      91.124      104.955      minutes"
"   Rainfall depth      49.792      49.792      49.792      mm"
"   Rainfall volume      1682.96      1682.96      3365.92      c.m"
"   Rainfall losses      33.893      5.585      19.739      mm"
"   Runoff depth      15.898      44.206      30.052      mm"
"   Runoff volume      537.36      1494.17      2031.54      c.m"
"   Runoff coefficient      0.319      0.888      0.604      "
"   Maximum flow      0.110      0.891      0.905      c.m/sec"
" 40 HYDROGRAPH Add Runoff "
"     4 Add Runoff "
"           0.905      1.051      0.146      0.045"
" 33 CATCHMENT 1100"
"     1 Triangular SCS"
"     1 Equal length"
"     1 SCS method"
"    1100 Catchment 1100"
"     0.000 % Impervious"
"     0.480 Total Area"
"    20.000 Flow length"
"     2.000 Overland Slope"
"     0.480 Pervious Area"
"    20.000 Pervious length"
"     2.000 Pervious slope"
"     0.000 Impervious Area"
"    20.000 Impervious length"
"     2.000 Impervious slope"
"     0.250 Pervious Manning 'n'"
"    78.000 Pervious SCS Curve No."
"     0.319 Pervious Runoff coefficient"
"     0.100 Pervious Ia/S coefficient"
"     7.164 Pervious Initial abstraction"
"     0.015 Impervious Manning 'n'"
"   98.000 Impervious SCS Curve No."
"     0.000 Impervious Runoff coefficient"
"     0.100 Impervious Ia/S coefficient"

```

```

"          Post__5yr
" 0.518  Impervious Initial abstraction"
"          0.028      1.051      0.146      0.045 c.m/sec"
"          Catchment 1100 Pervious Impervious Total Area "
"          Surface Area      0.480      0.000      0.480      hectare"
"          Time of concentration 14.957      1.691      14.957      minutes"
"          Time to Centroid      114.999      87.210      114.999      minutes"
"          Rainfall depth      49.792      49.792      49.792      mm"
"          Rainfall volume      239.00      0.00      239.00      c.m"
"          Rainfall losses      33.921      5.811      33.921      mm"
"          Runoff depth      15.871      43.981      15.871      mm"
"          Runoff volume      76.18      0.00      76.18      c.m"
"          Runoff coefficient      0.319      0.000      0.319      "
"          Maximum flow      0.028      0.000      0.028      c.m/sec"
" 40 HYDROGRAPH Add Runoff "
" 4  Add Runoff "
"          0.028      1.062      0.146      0.045"
" 40 HYDROGRAPH Copy to Outflow"
" 8  Copy to Outflow"
"          0.028      1.062      1.062      0.045"
" 40 HYDROGRAPH Combine 1"
" 6  Combine "
" 1  Node #"
"      Outlets to SWMF No. 1"
"          Maximum flow      1.062      c.m/sec"
"          Hydrograph volume      2932.428      c.m"
"          0.028      1.062      1.062      1.062"
" 40 HYDROGRAPH Confluence 1"
" 7  Confluence "
" 1  Node #"
"      Outlets to SWMF No. 1"
"          Maximum flow      1.062      c.m/sec"
"          Hydrograph volume      2932.428      c.m"
"          0.028      1.062      1.062      0.000"
" 54 POND DESIGN"
" 1.062  Current peak flow      c.m/sec"
" 0.250  Target outflow      c.m/sec"
" 2932.4  Hydrograph volume      c.m"
" 11.    Number of stages"
" 411.000  Minimum water level      metre"
" 412.000  Maximum water level      metre"
" 411.000  Starting water level      metre"
" 0      Keep Design Data: 1 = True; 0 = False"
"          Level Discharge      volume"
"          411.000      0.000      0.000"
"          411.100      0.05100      425.000"
"          411.200      0.1030      936.000"
"          411.300      0.1190      1459.000"
"          411.400      0.1330      1994.000"
"          411.500      0.3220      2542.000"
"          411.600      0.3510      3101.000"
"          411.700      0.3780      3673.000"
"          411.800      0.4030      4258.000"
"          411.850      0.4150      4554.000"
"          412.000      2.088      5464.000"
"          Peak outflow      0.124      c.m/sec"
"          Maximum level      411.333      metre"
"          Maximum storage      1636.316      c.m"
"          Centroidal lag      13.589      hours"
"          0.028      1.062      0.124      0.000 c.m/sec"
" 40 HYDROGRAPH Next link "
" 5  Next link "
"          0.028      0.124      0.124      0.000"
" 47 FILEI_0 Read/Open DIV01500.005hyd"

```

```

Post__5yr
"      1  1=read/open; 2=write/save"
"      2  1=rainfall; 2=hydrograph"
"      1  1=runoff; 2=inflow; 3=outflow; 4=junction"
"      DIV01500.005hyd"
"      Major flow at 1500"
"      Total volume          0.104    c.m"
"      Maximum flow         0.000    c.m/sec"
"      0.000    0.124    0.124    0.000 c.m/sec"
40  HYDROGRAPH Add Runoff "
"      4  Add Runoff "
"      0.000    0.124    0.124    0.000"
33  CATCHMENT 4000"
"      1  Triangular SCS"
"      1  Equal length"
"      1  SCS method"
"      4000 Catchment 4000"
"      0.000 % Impervious"
"      7.330 Total Area"
"      60.000 Flow length"
"      2.000 Overland Slope"
"      7.330 Pervious Area"
"      60.000 Pervious length"
"      2.000 Pervious slope"
"      0.000 Impervious Area"
"      60.000 Impervious length"
"      2.000 Impervious slope"
"      0.250 Pervious Manning 'n'"
"      50.000 Pervious SCS Curve No."
"      0.043 Pervious Runoff coefficient"
"      0.100 Pervious Ia/S coefficient"
"      25.400 Pervious Initial abstraction"
"      0.015 Impervious Manning 'n'"
"      98.000 Impervious SCS Curve No."
"      0.000 Impervious Runoff coefficient"
"      0.100 Impervious Ia/S coefficient"
"      0.518 Impervious Initial abstraction"
"      0.019    0.124    0.124    0.000 c.m/sec"
"      Catchment 4000 Pervious Impervious Total Area "
"      Surface Area      7.330    0.000    7.330    hectare"
"      Time of concentration 82.074    3.269    82.072    minutes"
"      Time to Centroid    193.297    89.581    193.294    minutes"
"      Rainfall depth      49.792    49.792    49.792    mm"
"      Rainfall volume     3649.73    0.00    3649.73    c.m"
"      Rainfall losses     47.655    6.236    47.655    mm"
"      Runoff depth        2.137    43.556    2.137    mm"
"      Runoff volume       156.63    0.00    156.64    c.m"
"      Runoff coefficient   0.043    0.000    0.043    "
"      Maximum flow       0.019    0.000    0.019    c.m/sec"
40  HYDROGRAPH Add Runoff "
"      4  Add Runoff "
"      0.019    0.143    0.124    0.000"
54  POND DESIGN"
"      0.143 Current peak flow    c.m/sec"
"      0.250 Target outflow    c.m/sec"
"      3086.2 Hydrograph volume    c.m"
"      6. Number of stages"
"      409.630 Minimum water level    metre"
"      410.750 Maximum water level    metre"
"      409.630 Starting water level    metre"
"      0 Keep Design Data: 1 = True; 0 = False"
"      Level Discharge    Volume"
"      409.630    0.000    0.000"
"      409.750    0.6650    405.300"

```

```

"                                     Post__5yr
"           410.000      3.601  2191.000"
"           410.250      7.811  5322.000"
"           410.500     12.984  9645.400"
"           410.750     18.965 15230.80"
"           Peak outflow                0.142   c.m/sec"
"           Maximum level                409.656  metre"
"           Maximum storage              86.642   c.m"
"           Centroidal lag              13.232   hours"
"           0.019      0.143      0.142      0.000 c.m/sec"
" 40     HYDROGRAPH Next link "
"           5 Next link "
"           0.019      0.142      0.142      0.000"
" 52     CHANNEL DESIGN"
"           0.142 Current peak flow      c.m/sec"
"           0.035 Manning 'n'"
"           0. Cross-section type: 0=trapezoidal; 1=general"
"           0.000 Basewidth      metre"
"           7.410 Left bank slope"
"           6.000 Right bank slope"
"           0.950 Channel depth      metre"
"           1.040 Gradient      %"
"           Depth of flow                0.188   metre"
"           Velocity                    0.598   m/sec"
"           Channel capacity             10.655  c.m/sec"
"           Critical depth               0.156   metre"
" 53     ROUTE Channel Route 72"
"           72.40 Channel Route 72 Reach length (metre)"
"           0.453 X-factor <= 0.5"
"           90.765 K-lag (seconds)"
"           0.000 Default(0) or user spec.(1) values used"
"           0.500 X-factor <= 0.5"
"           30.000 K-lag (seconds)"
"           0.500 Beta weighting factor"
"           75.000 Routing time step (seconds)"
"           1 No. of sub-reaches"
"           Peak outflow                0.142   c.m/sec"
"           0.019      0.142      0.142      0.000 c.m/sec"
" 40     HYDROGRAPH Next link "
"           5 Next link "
"           0.019      0.142      0.142      0.000"
" 52     CHANNEL DESIGN"
"           0.142 Current peak flow      c.m/sec"
"           0.035 Manning 'n'"
"           0. Cross-section type: 0=trapezoidal; 1=general"
"           2.000 Basewidth      metre"
"           2.950 Left bank slope"
"           3.000 Right bank slope"
"           0.950 Channel depth      metre"
"           1.040 Gradient      %"
"           Depth of flow                0.104   metre"
"           Velocity                    0.589   m/sec"
"           Channel capacity             9.246   c.m/sec"
"           Critical depth               0.077   metre"
" 53     ROUTE Channel Route 40"
"           39.80 Channel Route 40 Reach length (metre)"
"           0.427 X-factor <= 0.5"
"           50.699 K-lag (seconds)"
"           0.000 Default(0) or user spec.(1) values used"
"           0.500 X-factor <= 0.5"
"           30.000 K-lag (seconds)"
"           0.500 Beta weighting factor"
"           50.000 Routing time step (seconds)"
"           1 No. of sub-reaches"

```

			Post__5yr		
"	Peak outflow		0.142		c.m/sec"
"	0.019	0.142	0.142		0.000 c.m/sec"
" 40	HYDROGRAPH Combine	100"			
"	6 Combine "				
"	100 Node #"				
"	Existing wetland"				
"	Maximum flow		0.142		c.m/sec"
"	Hydrograph volume		3085.926		c.m"
"	0.019	0.142	0.142		0.142"
" 40	HYDROGRAPH Start - New Tributary"				
"	2 Start - New Tributary"				
"	0.019	0.000	0.142		0.142"
" 33	CATCHMENT 2100"				
"	1 Triangular SCS"				
"	1 Equal length"				
"	1 SCS method"				
"	2100 Catchment 2100"				
"	60.000 % Impervious"				
"	1.960 Total Area"				
"	40.000 Flow length"				
"	2.000 Overland Slope"				
"	0.784 Pervious Area"				
"	40.000 Pervious length"				
"	2.000 Pervious slope"				
"	1.176 Impervious Area"				
"	40.000 Impervious length"				
"	2.000 Impervious slope"				
"	0.250 Pervious Manning 'n'"				
"	78.000 Pervious SCS Curve No."				
"	0.319 Pervious Runoff coefficient"				
"	0.100 Pervious Ia/S coefficient"				
"	7.164 Pervious Initial abstraction"				
"	0.015 Impervious Manning 'n'"				
"	98.000 Impervious SCS Curve No."				
"	0.878 Impervious Runoff coefficient"				
"	0.100 Impervious Ia/S coefficient"				
"	0.518 Impervious Initial abstraction"				
"	0.304	0.000	0.142		0.142 c.m/sec"
"	Catchment 2100	Pervious	Impervious	Total Area	"
"	Surface Area	0.784	1.176	1.960	hectare"
"	Time of concentration	22.670	2.563	6.484	minutes"
"	Time to Centroid	124.006	88.517	95.437	minutes"
"	Rainfall depth	49.792	49.792	49.792	mm"
"	Rainfall volume	390.37	585.55	975.92	c.m"
"	Rainfall losses	33.904	6.066	17.201	mm"
"	Runoff depth	15.888	43.726	32.591	mm"
"	Runoff volume	124.56	514.22	638.78	c.m"
"	Runoff coefficient	0.319	0.878	0.655	"
"	Maximum flow	0.036	0.295	0.304	c.m/sec"
" 40	HYDROGRAPH Add Runoff "				
"	4 Add Runoff "				
"	0.304	0.304	0.142		0.142"
" 33	CATCHMENT 2400"				
"	1 Triangular SCS"				
"	1 Equal length"				
"	1 SCS method"				
"	2400 Catchment 2400"				
"	90.000 % Impervious"				
"	0.790 Total Area"				
"	20.000 Flow length"				
"	2.000 Overland Slope"				
"	0.079 Pervious Area"				
"	20.000 Pervious length"				

```

Post__5yr
"      2.000 Pervious slope"
"      0.711 Impervious Area"
"     20.000 Impervious length"
"      2.000 Impervious slope"
"      0.250 Pervious Manning 'n'"
"     78.000 Pervious SCS Curve No."
"      0.319 Pervious Runoff coefficient"
"      0.100 Pervious Ia/S coefficient"
"      7.164 Pervious Initial abstraction"
"      0.015 Impervious Manning 'n'"
"     98.000 Impervious SCS Curve No."
"      0.883 Impervious Runoff coefficient"
"      0.100 Impervious Ia/S coefficient"
"      0.518 Impervious Initial abstraction"
"          0.175      0.304      0.142      0.142 c.m/sec"
"      Catchment 2400 Pervious Impervious Total Area "
"      Surface Area      0.079      0.711      0.790 hectare"
"      Time of concentration 14.957      1.691      2.203 minutes"
"      Time to Centroid 115.000      87.210      88.281 minutes"
"      Rainfall depth 49.792      49.792      49.792 mm"
"      Rainfall volume 39.34      354.02      393.35 c.m"
"      Rainfall losses 33.921      5.811      8.622 mm"
"      Runoff depth 15.871      43.981      41.170 mm"
"      Runoff volume 12.54      312.70      325.24 c.m"
"      Runoff coefficient 0.319      0.883      0.827 "
"      Maximum flow 0.005      0.175      0.175 c.m/sec"
40 HYDROGRAPH Add Runoff "
"      4 Add Runoff "
"          0.175      0.479      0.142      0.142"
54 POND DESIGN"
"      0.479 Current peak flow c.m/sec"
"      0.020 Target outflow c.m/sec"
"     964.0 Hydrograph volume c.m"
"      13. Number of stages"
"     410.650 Minimum water level metre"
"     411.950 Maximum water level metre"
"     410.650 Starting water level metre"
"      0 Keep Design Data: 1 = True; 0 = False"
"          Level Discharge Volume"
"     410.650      0.000      0.000"
"     410.700      0.00600      42.000"
"     410.800      0.01300      130.000"
"     410.900      0.02000      225.000"
"     411.000      0.02500      328.000"
"     411.100      0.02900      439.000"
"     411.200      0.1260      558.000"
"     411.300      0.1390      686.000"
"     411.400      0.1510      822.000"
"     411.500      0.1630      967.000"
"     411.600      0.1730      1121.000"
"     411.650      0.1780      1202.000"
"     411.950      2.575      1742.000"
"      Peak outflow      0.119 c.m/sec"
"      Maximum level 411.193 metre"
"      Maximum storage 549.320 c.m"
"      Centroidal lag 4.059 hours"
"          0.175      0.479      0.119      0.142 c.m/sec"
40 HYDROGRAPH Next link "
"      5 Next link "
"          0.175      0.119      0.119      0.142"
33 CATCHMENT 2300"
"      1 Triangular SCS"
"      1 Equal length"

```

```

"      1  SCS method"
"      2300 Catchment 2300"
"     10.000 % Impervious"
"      0.480 Total Area"
"     20.000 Flow length"
"      2.000 Overland Slope"
"      0.432 Pervious Area"
"     20.000 Pervious length"
"      2.000 Pervious slope"
"      0.048 Impervious Area"
"     20.000 Impervious length"
"      2.000 Impervious slope"
"      0.250 Pervious Manning 'n'"
"     78.000 Pervious SCS Curve No."
"      0.319 Pervious Runoff coefficient"
"      0.100 Pervious Ia/S coefficient"
"      7.164 Pervious Initial abstraction"
"      0.015 Impervious Manning 'n'"
"     98.000 Impervious SCS Curve No."
"      0.883 Impervious Runoff coefficient"
"      0.100 Impervious Ia/S coefficient"
"      0.518 Impervious Initial abstraction"
"          0.030      0.119      0.119      0.142 c.m/sec"
"      Catchment 2300      Pervious      Impervious      Total Area      "
"      Surface Area      0.432      0.048      0.480      hectare"
"      Time of concentration      14.957      1.691      11.834      minutes"
"      Time to Centroid      114.999      87.210      108.457      minutes"
"      Rainfall depth      49.792      49.792      49.792      mm"
"      Rainfall volume      215.10      23.90      239.00      c.m"
"      Rainfall losses      33.921      5.811      31.110      mm"
"      Runoff depth      15.871      43.981      18.682      mm"
"      Runoff volume      68.56      21.11      89.67      c.m"
"      Runoff coefficient      0.319      0.883      0.375      "
"      Maximum flow      0.025      0.012      0.030      c.m/sec"
" 40      HYDROGRAPH Add Runoff "
"      4      Add Runoff "
"          0.030      0.138      0.119      0.142"
" 40      HYDROGRAPH Copy to Outflow"
"      8      Copy to Outflow"
"          0.030      0.138      0.138      0.142"
" 40      HYDROGRAPH Combine 200"
"      6      Combine "
"     200      Node #"
"          To Trib. of Grand River"
"          Maximum flow      0.138      c.m/sec"
"          Hydrograph volume      1052.909      c.m"
"          0.030      0.138      0.138      0.138"
" 40      HYDROGRAPH Start - New Tributary"
"      2      Start - New Tributary"
"          0.030      0.000      0.138      0.138"
" 33      CATCHMENT 2200"
"      1      Triangular SCS"
"      1      Equal length"
"      1      SCS method"
"     2200 Catchment 2200"
"     75.000 % Impervious"
"      0.920 Total Area"
"     40.000 Flow length"
"      2.000 Overland Slope"
"      0.230 Pervious Area"
"     40.000 Pervious length"
"      2.000 Pervious slope"
"      0.690 Impervious Area"

```

```

Post__5yr
" 40.000 Impervious length"
" 2.000 Impervious slope"
" 0.250 Pervious Manning 'n'"
" 78.000 Pervious SCS Curve No."
" 0.319 Pervious Runoff coefficient"
" 0.100 Pervious Ia/S coefficient"
" 7.164 Pervious Initial abstraction"
" 0.015 Impervious Manning 'n'"
" 98.000 Impervious SCS Curve No."
" 0.878 Impervious Runoff coefficient"
" 0.100 Impervious Ia/S coefficient"
" 0.518 Impervious Initial abstraction"
" 0.176 0.000 0.138 0.138 c.m/sec"
" Catchment 2200 Pervious Impervious Total Area "
" Surface Area 0.230 0.690 0.920 hectare"
" Time of concentration 22.670 2.563 4.735 minutes"
" Time to Centroid 124.006 88.517 92.351 minutes"
" Rainfall depth 49.792 49.792 49.792 mm"
" Rainfall volume 114.52 343.56 458.08 c.m"
" Rainfall losses 33.904 6.066 13.025 mm"
" Runoff depth 15.888 43.726 36.767 mm"
" Runoff volume 36.54 301.71 338.25 c.m"
" Runoff coefficient 0.319 0.878 0.738 "
" Maximum flow 0.011 0.173 0.176 c.m/sec"
40 HYDROGRAPH Add Runoff "
" 4 Add Runoff "
" 0.176 0.176 0.138 0.138"
54 POND DESIGN"
" 0.176 Current peak flow c.m/sec"
" 0.756 Target outflow c.m/sec"
" 338.3 Hydrograph volume c.m"
" 12. Number of stages"
" 413.700 Minimum water level metre"
" 415.000 Maximum water level metre"
" 413.700 Starting water level metre"
" 0 Keep Design Data: 1 = True; 0 = False"
" Level Discharge volume"
" 413.700 0.000 0.000"
" 413.800 0.00500 88.600"
" 413.900 0.01000 187.200"
" 414.000 0.01300 298.400"
" 414.100 0.01500 422.200"
" 414.200 0.2220 558.900"
" 414.300 0.2590 708.500"
" 414.400 0.2910 871.100"
" 414.500 0.3210 1046.900"
" 414.600 0.3470 1236.100"
" 414.700 0.3720 1438.700"
" 415.000 2.808 2087.400"
" Peak outflow 0.012 c.m/sec"
" Maximum level 413.963 metre"
" Maximum storage 257.625 c.m"
" Centroidal lag 6.867 hours"
" 0.176 0.176 0.012 0.138 c.m/sec"
40 HYDROGRAPH Combine 200"
" 6 Combine "
" 200 Node #"
" To Trib. of Grand River"
" Maximum flow 0.149 c.m/sec"
" Hydrograph volume 1391.158 c.m"
" 0.176 0.176 0.012 0.149"
40 HYDROGRAPH Start - New Tributary"
" 2 Start - New Tributary"

```

			Post__5yr		
"		0.176	0.000	0.012	0.149"
" 33	CATCHMENT 3200"				
"	1 Triangular SCS"				
"	1 Equal length"				
"	1 SCS method"				
"	3200 Catchment 3200"				
"	60.000 % Impervious"				
"	0.530 Total Area"				
"	40.000 Flow length"				
"	1.000 Overland Slope"				
"	0.212 Pervious Area"				
"	40.000 Pervious length"				
"	1.000 Pervious slope"				
"	0.318 Impervious Area"				
"	40.000 Impervious length"				
"	1.000 Impervious slope"				
"	0.250 Pervious Manning 'n'"				
"	78.000 Pervious SCS Curve No."				
"	0.319 Pervious Runoff coefficient"				
"	0.100 Pervious Ia/S coefficient"				
"	7.164 Pervious Initial abstraction"				
"	0.015 Impervious Manning 'n'"				
"	98.000 Impervious SCS Curve No."				
"	0.877 Impervious Runoff coefficient"				
"	0.100 Impervious Ia/S coefficient"				
"	0.518 Impervious Initial abstraction"				
"		0.084	0.000	0.012	0.149 c.m/sec"
"	Catchment 3200	Pervious	Impervious	Total Area	"
"	Surface Area	0.212	0.318	0.530	hectare"
"	Time of concentration	27.910	3.156	7.991	minutes"
"	Time to Centroid	130.112	89.411	97.361	minutes"
"	Rainfall depth	49.792	49.792	49.792	mm"
"	Rainfall volume	105.56	158.34	263.90	c.m"
"	Rainfall losses	33.900	6.148	17.249	mm"
"	Runoff depth	15.891	43.643	32.543	mm"
"	Runoff volume	33.69	138.79	172.48	c.m"
"	Runoff coefficient	0.319	0.877	0.654	"
"	Maximum flow	0.009	0.083	0.084	c.m/sec"
" 40	HYDROGRAPH Add Runoff "				
"	4 Add Runoff "				
"		0.084	0.084	0.012	0.149"
" 33	CATCHMENT 3300"				
"	1 Triangular SCS"				
"	1 Equal length"				
"	1 SCS method"				
"	3300 Catchment 3300"				
"	60.000 % Impervious"				
"	0.240 Total Area"				
"	20.000 Flow length"				
"	2.000 Overland Slope"				
"	0.096 Pervious Area"				
"	20.000 Pervious length"				
"	2.000 Pervious slope"				
"	0.144 Impervious Area"				
"	20.000 Impervious length"				
"	2.000 Impervious slope"				
"	0.250 Pervious Manning 'n'"				
"	78.000 Pervious SCS Curve No."				
"	0.319 Pervious Runoff coefficient"				
"	0.100 Pervious Ia/S coefficient"				
"	7.164 Pervious Initial abstraction"				
"	0.015 Impervious Manning 'n'"				
"	98.000 Impervious SCS Curve No."				

			Post_5yr		
"	0.883	Impervious Runoff coefficient"			
"	0.100	Impervious Ia/S coefficient"			
"	0.518	Impervious Initial abstraction"			
"		0.037	0.084	0.012	0.149 c.m/sec"
"		Catchment 3300	Pervious	Impervious	Total Area "
"		Surface Area	0.096	0.144	0.240 hectare"
"		Time of concentration	14.957	1.691	4.264 minutes"
"		Time to Centroid	115.000	87.210	92.599 minutes"
"		Rainfall depth	49.792	49.792	49.792 mm"
"		Rainfall volume	47.80	71.70	119.50 c.m"
"		Rainfall losses	33.921	5.811	17.055 mm"
"		Runoff depth	15.871	43.981	32.737 mm"
"		Runoff volume	15.24	63.33	78.57 c.m"
"		Runoff coefficient	0.319	0.883	0.657 "
"		Maximum flow	0.006	0.035	0.037 c.m/sec"
" 40		HYDROGRAPH Add Runoff "			
"	4	Add Runoff "			
"		0.037	0.121	0.012	0.149"
" 40		HYDROGRAPH Copy to Outflow"			
"	8	Copy to Outflow"			
"		0.037	0.121	0.121	0.149"
" 40		HYDROGRAPH Combine 300"			
"	6	Combine "			
"	300	Node #"			
"		To Walser Street"			
"		Maximum flow	0.121		c.m/sec"
"		Hydrograph volume	251.044		c.m"
"		0.037	0.121	0.121	0.121"
" 40		HYDROGRAPH Confluence 300"			
"	7	Confluence "			
"	300	Node #"			
"		To Walser Street"			
"		Maximum flow	0.121		c.m/sec"
"		Hydrograph volume	251.044		c.m"
"		0.037	0.121	0.121	0.000"
" 40		HYDROGRAPH Copy to Outflow"			
"	8	Copy to Outflow"			
"		0.037	0.121	0.121	0.000"
" 40		HYDROGRAPH Combine 100"			
"	6	Combine "			
"	100	Node #"			
"		Existing wetland"			
"		Maximum flow	0.150		c.m/sec"
"		Hydrograph volume	3336.969		c.m"
"		0.037	0.121	0.121	0.150"
" 40		HYDROGRAPH Confluence 100"			
"	7	Confluence "			
"	100	Node #"			
"		Existing wetland"			
"		Maximum flow	0.150		c.m/sec"
"		Hydrograph volume	3336.970		c.m"
"		0.037	0.150	0.121	0.000"
" 40		HYDROGRAPH Copy to Outflow"			
"	8	Copy to Outflow"			
"		0.037	0.150	0.150	0.000"
" 40		HYDROGRAPH Combine 200"			
"	6	Combine "			
"	200	Node #"			
"		To Trib. of Grand River"			
"		Maximum flow	0.280		c.m/sec"
"		Hydrograph volume	4728.137		c.m"
"		0.037	0.150	0.150	0.280"
" 40		HYDROGRAPH Confluence 200"			

"			Post__5yr			
"	7	Confluence "				
"	200	Node #"				
"		To Trib. of Grand River"				
"		Maximum flow	0.280		c.m/sec"	
"		Hydrograph volume	4728.137		c.m"	
"		0.037	0.280	0.150	0.000"	
" 38		START/RE-START TOTALS 200"				
"	3	Runoff Totals on EXIT"				
"		Total Catchment area		22.640	hectare"	
"		Total Impervious area		7.856	hectare"	
"		Total % impervious		34.700"		
" 19		EXIT"				

```

"                                     Post__10yr
"
" MIDUSS Output ----->"
" MIDUSS version                      Version 2.25 rev. 473"
" MIDUSS created                      Sunday, February 07, 2010"
" 10  Units used:                      ie METRIC"
" Job folder:                         w:\Kitchener\411-2011\411009\Design Data\
"                                     Modelling Files\2019-02-15"
" Output filename:                    Post__10yr.out"
" Licensee name:                      gmbp"
" Company                             Hewlett-Packard Company"
" Date & Time last used:              2/15/2019 at 2:48:35 PM"
" 31  TIME PARAMETERS"
"      5.000  Time Step"
"      180.000  Max. Storm length"
" 12000.000  Max. Hydrograph"
" 32  STORM Chicago storm"
"      1  Chicago storm"
" 2327.596  Coefficient A"
"      19.500  Constant B"
"      0.894  Exponent C"
"      0.380  Fraction R"
" 180.000  Duration"
"      1.000  Time step multiplier"
"      Maximum intensity              126.171  mm/hr"
"      Total depth                    61.359  mm"
" 6  010hyd  Hydrograph extension used in this file"
" 33  CATCHMENT 1200"
"      1  Triangular SCS"
"      1  Equal length"
"      1  SCS method"
"      1200  Catchment 1200"
"      50.000  % Impervious"
"      0.220  Total Area"
"      10.000  Flow length"
"      2.000  Overland slope"
"      0.110  Pervious Area"
"      10.000  Pervious length"
"      2.000  Pervious slope"
"      0.110  Impervious Area"
"      10.000  Impervious length"
"      2.000  Impervious slope"
"      0.250  Pervious Manning 'n'"
"      78.000  Pervious SCS Curve No."
"      0.379  Pervious Runoff coefficient"
"      0.100  Pervious Ia/S coefficient"
"      7.164  Pervious Initial abstraction"
"      0.015  Impervious Manning 'n'"
"      98.000  Impervious SCS Curve No."
"      0.887  Impervious Runoff coefficient"
"      0.100  Impervious Ia/S coefficient"
"      0.518  Impervious Initial abstraction"
"      0.037  0.000  0.000  0.000 c.m/sec"
"      Catchment 1200  Pervious  Impervious  Total Area  "
"      Surface Area    0.110    0.110    0.220    hectare"
"      Time of concentration  8.639    1.063    3.329    minutes"
"      Time to Centroid  106.058    85.846    91.893    minutes"
"      Rainfall depth    61.359    61.359    61.359    mm"
"      Rainfall volume    67.50    67.50    134.99    c.m"
"      Rainfall losses    38.124    6.938    22.531    mm"
"      Runoff depth      23.235    54.421    38.828    mm"
"      Runoff volume      25.56    59.86    85.42    c.m"
"      Runoff coefficient  0.379    0.887    0.633    "
"      Maximum flow      0.011    0.032    0.037    c.m/sec"
" 40  HYDROGRAPH Add Runoff "

```



```

Post__10yr
"      4  Add Runoff "
"      0.037      0.037      0.000      0.000"
" 33    CATCHMENT 1300"
"      1  Triangular SCS"
"      1  Equal length"
"      1  SCS method"
"      1300  Catchment 1300"
"      50.000  % Impervious"
"      0.840  Total Area"
"      20.000  Flow length"
"      2.000  Overland Slope"
"      0.420  Pervious Area"
"      20.000  Pervious length"
"      2.000  Pervious slope"
"      0.420  Impervious Area"
"      20.000  Impervious length"
"      2.000  Impervious slope"
"      0.250  Pervious Manning 'n'"
"      78.000  Pervious SCS Curve No."
"      0.379  Pervious Runoff coefficient"
"      0.100  Pervious Ia/S coefficient"
"      7.164  Pervious Initial abstraction"
"      0.015  Impervious Manning 'n'"
"      98.000  Impervious SCS Curve No."
"      0.901  Impervious Runoff coefficient"
"      0.100  Impervious Ia/S coefficient"
"      0.518  Impervious Initial abstraction"
"      0.137      0.037      0.000      0.000 c.m/sec"
"      Catchment 1300      Pervious      Impervious      Total Area "
"      Surface Area      0.420      0.420      0.840      hectare"
"      Time of concentration      13.094      1.611      5.010      minutes"
"      Time to Centroid      111.234      86.563      93.866      minutes"
"      Rainfall depth      61.359      61.359      61.359      mm"
"      Rainfall volume      257.71      257.71      515.42      c.m"
"      Rainfall losses      38.098      6.044      22.071      mm"
"      Runoff depth      23.262      55.315      39.288      mm"
"      Runoff volume      97.70      232.32      330.02      c.m"
"      Runoff coefficient      0.379      0.901      0.640      "
"      Maximum flow      0.038      0.121      0.137      c.m/sec"
" 40    HYDROGRAPH Add Runoff "
"      4  Add Runoff "
"      0.137      0.174      0.000      0.000"
" 33    CATCHMENT 1600"
"      1  Triangular SCS"
"      1  Equal length"
"      1  SCS method"
"      1600  Catchment 1600"
"      50.000  % Impervious"
"      0.360  Total Area"
"      15.000  Flow length"
"      2.000  Overland Slope"
"      0.180  Pervious Area"
"      15.000  Pervious length"
"      2.000  Pervious slope"
"      0.180  Impervious Area"
"      15.000  Impervious length"
"      2.000  Impervious slope"
"      0.250  Pervious Manning 'n'"
"      78.000  Pervious SCS Curve No."
"      0.380  Pervious Runoff coefficient"
"      0.100  Pervious Ia/S coefficient"
"      7.164  Pervious Initial abstraction"
"      0.015  Impervious Manning 'n'"

```

Post__10yr

```

"      1  SCS method"
"      1400 Catchment 1400"
"      20.000 % Impervious"
"      0.620 Total Area"
"      30.000 Flow length"
"      2.000 Overland Slope"
"      0.496 Pervious Area"
"      30.000 Pervious length"
"      2.000 Pervious slope"
"      0.124 Impervious Area"
"      30.000 Impervious length"
"      2.000 Impervious slope"
"      0.250 Pervious Manning 'n'"
"      78.000 Pervious SCS Curve No."
"      0.380 Pervious Runoff coefficient"
"      0.100 Pervious Ia/S coefficient"
"      7.164 Pervious Initial abstraction"
"      0.015 Impervious Manning 'n'"
"      98.000 Impervious SCS Curve No."
"      0.900 Impervious Runoff coefficient"
"      0.100 Impervious Ia/S coefficient"
"      0.518 Impervious Initial abstraction"
"      0.056      0.000      0.127      0.127 c.m/sec"
"      Catchment 1400      Pervious      Impervious      Total Area "
"      Surface Area      0.496      0.124      0.620      hectare"
"      Time of concentration      16.700      2.054      11.252      minutes"
"      Time to Centroid      115.361      87.160      104.869      minutes"
"      Rainfall depth      61.359      61.359      61.359      mm"
"      Rainfall volume      304.34      76.09      380.43      c.m"
"      Rainfall losses      38.059      6.144      31.676      mm"
"      Runoff depth      23.300      55.215      29.683      mm"
"      Runoff volume      115.57      68.47      184.04      c.m"
"      Runoff coefficient      0.380      0.900      0.484      "
"      Maximum flow      0.040      0.036      0.056      c.m/sec"
" 40      HYDROGRAPH Add Runoff "
"      4      Add Runoff "
"      0.056      0.056      0.127      0.127"
" 54      POND DESIGN"
"      0.056      Current peak flow      c.m/sec"
"      0.250      Target outflow      c.m/sec"
"      184.0      Hydrograph volume      c.m"
"      17.      Number of stages"
"      413.920      Minimum water level      metre"
"      415.520      Maximum water level      metre"
"      413.920      Starting water level      metre"
"      0      Keep Design Data: 1 = True; 0 = False"
"      Level Discharge      Volume"
"      413.920      0.00089      0.000"
"      414.020      0.00089      26.670"
"      414.120      0.00090      54.610"
"      414.220      0.00090      82.540"
"      414.320      0.00090      110.480"
"      414.420      0.00091      138.420"
"      414.520      0.00091      165.090"
"      414.620      0.00091      191.760"
"      414.720      0.00091      191.830"
"      414.820      0.02640      191.900"
"      414.920      0.03734      191.970"
"      415.020      0.04573      192.040"
"      415.120      0.05281      192.120"
"      415.220      0.2777      201.400"
"      415.320      0.6941      238.900"
"      415.420      1.244      304.650"

```

			Post_10yr		
	415.520	1.909	382.150"		
	Peak outflow		0.001	c.m/sec"	
	Maximum level		414.420	metre"	
	Maximum storage		138.498	c.m"	
	Centroidal lag		29.934	hours"	
	0.056	0.056	0.001	0.127	c.m/sec"
40	HYDROGRAPH Next link "				
	5 Next link "				
	0.056	0.001	0.001	0.127"	
33	CATCHMENT 1500"				
	1 Triangular SCS"				
	1 Equal length"				
	1 SCS method"				
	1500 Catchment 1500"				
	50.000 % Impervious"				
	1.110 Total Area"				
	40.000 Flow length"				
	2.000 Overland Slope"				
	0.555 Pervious Area"				
	40.000 Pervious length"				
	2.000 Pervious slope"				
	0.555 Impervious Area"				
	40.000 Impervious length"				
	2.000 Impervious slope"				
	0.250 Pervious Manning 'n'"				
	78.000 Pervious SCS Curve No."				
	0.380 Pervious Runoff coefficient"				
	0.100 Pervious Ia/S coefficient"				
	7.164 Pervious Initial abstraction"				
	0.015 Impervious Manning 'n'"				
	98.000 Impervious SCS Curve No."				
	0.897 Impervious Runoff coefficient"				
	0.100 Impervious Ia/S coefficient"				
	0.518 Impervious Initial abstraction"				
	0.174	0.001	0.001	0.127	c.m/sec"
	Catchment 1500	Pervious	Impervious	Total Area	"
	Surface Area	0.555	0.555	1.110	hectare"
	Time of concentration	19.847	2.441	7.618	minutes"
	Time to Centroid	118.992	87.742	97.037	minutes"
	Rainfall depth	61.359	61.359	61.359	mm"
	Rainfall volume	340.54	340.54	681.09	c.m"
	Rainfall losses	38.054	6.310	22.182	mm"
	Runoff depth	23.305	55.050	39.177	mm"
	Runoff volume	129.34	305.52	434.87	c.m"
	Runoff coefficient	0.380	0.897	0.638	"
	Maximum flow	0.041	0.162	0.174	c.m/sec"
40	HYDROGRAPH Add Runoff "				
	4 Add Runoff "				
	0.174	0.175	0.001	0.127"	
56	DIVERSION"				
	1500 Node number"				
	0.146 Overflow threshold"				
	1.000 Required diverted fraction"				
	0 Conduit type; 1=Pipe;2=Channel"				
	Peak of diverted flow	0.029			c.m/sec"
	Volume of diverted flow	11.178			c.m"
	DIV01500.010hyd"				
	Major flow at 1500"				
	0.174	0.175	0.146	0.127	c.m/sec"
40	HYDROGRAPH Next link "				
	5 Next link "				
	0.174	0.146	0.146	0.127"	
33	CATCHMENT 1000"				

```

"      1 Triangular SCS"
"      1 Equal length"
"      1 SCS method"
"    1000 Catchment 1000"
"    50.000 % Impervious"
"     6.760 Total Area"
"   100.000 Flow length"
"     2.000 Overland Slope"
"     3.380 Pervious Area"
"   100.000 Pervious length"
"     2.000 Pervious slope"
"     3.380 Impervious Area"
"   100.000 Impervious length"
"     2.000 Impervious slope"
"     0.250 Pervious Manning 'n'"
"    78.000 Pervious SCS Curve No."
"     0.380 Pervious Runoff coefficient"
"     0.100 Pervious Ia/S coefficient"
"     7.164 Pervious Initial abstraction"
"     0.015 Impervious Manning 'n'"
"   98.000 Impervious SCS Curve No."
"     0.905 Impervious Runoff coefficient"
"     0.100 Impervious Ia/S coefficient"
"     0.518 Impervious Initial abstraction"
"           1.059      0.146      0.146      0.127 c.m/sec"
"   Catchment 1000      Pervious      Impervious      Total Area "
"   Surface Area      3.380      3.380      6.760      hectare"
"   Time of concentration      34.392      4.230      13.155      minutes"
"   Time to Centroid      135.773      90.174      103.666      minutes"
"   Rainfall depth      61.359      61.359      61.359      mm"
"   Rainfall volume      2073.94      2073.94      4147.88      c.m"
"   Rainfall losses      38.029      5.843      21.936      mm"
"   Runoff depth      23.330      55.517      39.424      mm"
"   Runoff volume      788.57      1876.46      2665.03      c.m"
"   Runoff coefficient      0.380      0.905      0.643      "
"   Maximum flow      0.182      1.031      1.059      c.m/sec"
" 40 HYDROGRAPH Add Runoff "
"     4 Add Runoff "
"           1.059      1.205      0.146      0.127"
" 33 CATCHMENT 1100"
"     1 Triangular SCS"
"     1 Equal length"
"     1 SCS method"
"    1100 Catchment 1100"
"     0.000 % Impervious"
"     0.480 Total Area"
"    20.000 Flow length"
"     2.000 Overland Slope"
"     0.480 Pervious Area"
"    20.000 Pervious length"
"     2.000 Pervious slope"
"     0.000 Impervious Area"
"    20.000 Impervious length"
"     2.000 Impervious slope"
"     0.250 Pervious Manning 'n'"
"    78.000 Pervious SCS Curve No."
"     0.379 Pervious Runoff coefficient"
"     0.100 Pervious Ia/S coefficient"
"     7.164 Pervious Initial abstraction"
"     0.015 Impervious Manning 'n'"
"   98.000 Impervious SCS Curve No."
"     0.000 Impervious Runoff coefficient"
"     0.100 Impervious Ia/S coefficient"

```

```

"         Post_10yr
"         0.518  Impervious Initial abstraction"
"             0.043      1.205      0.146      0.127 c.m/sec"
"         Catchment 1100 Pervious Impervious Total Area "
"         Surface Area      0.480      0.000      0.480      hectare"
"         Time of concentration 13.094      1.611      13.094      minutes"
"         Time to Centroid      111.234      86.563      111.234      minutes"
"         Rainfall depth      61.359      61.359      61.359      mm"
"         Rainfall volume      294.52      0.00      294.52      c.m"
"         Rainfall losses      38.098      6.044      38.097      mm"
"         Runoff depth      23.262      55.315      23.262      mm"
"         Runoff volume      111.66      0.00      111.66      c.m"
"         Runoff coefficient      0.379      0.000      0.379      "
"         Maximum flow      0.043      0.000      0.043      c.m/sec"
" 40     HYDROGRAPH Add Runoff "
"         4     Add Runoff "
"             0.043      1.226      0.146      0.127"
" 40     HYDROGRAPH Copy to Outflow"
"         8     Copy to Outflow"
"             0.043      1.226      1.226      0.127"
" 40     HYDROGRAPH Combine 1"
"         6     Combine "
"         1     Node #"
"             Outlets to SWMF No. 1"
"             Maximum flow      1.226      c.m/sec"
"             Hydrograph volume      3869.559      c.m"
"             0.043      1.226      1.226      1.226"
" 40     HYDROGRAPH Confluence 1"
"         7     Confluence "
"         1     Node #"
"             Outlets to SWMF No. 1"
"             Maximum flow      1.226      c.m/sec"
"             Hydrograph volume      3869.559      c.m"
"             0.043      1.226      1.226      0.000"
" 54     POND DESIGN"
"         1.226     Current peak flow      c.m/sec"
"         0.250     Target outflow      c.m/sec"
"         3869.6     Hydrograph volume      c.m"
"         11.     Number of stages"
"         411.000     Minimum water level      metre"
"         412.000     Maximum water level      metre"
"         411.000     Starting water level      metre"
"         0     Keep Design Data: 1 = True; 0 = False"
"             Level Discharge      volume"
"             411.000      0.000      0.000"
"             411.100      0.05100      425.000"
"             411.200      0.1030      936.000"
"             411.300      0.1190      1459.000"
"             411.400      0.1330      1994.000"
"             411.500      0.3220      2542.000"
"             411.600      0.3510      3101.000"
"             411.700      0.3780      3673.000"
"             411.800      0.4030      4258.000"
"             411.850      0.4150      4554.000"
"             412.000      2.088      5464.000"
"             Peak outflow      0.214      c.m/sec"
"             Maximum level      411.443      metre"
"             Maximum storage      2228.205      c.m"
"             Centroidal lag      12.150      hours"
"             0.043      1.226      0.214      0.000 c.m/sec"
" 40     HYDROGRAPH Next link "
"         5     Next link "
"             0.043      0.214      0.214      0.000"
" 47     FILEI_0 Read/Open DIV01500.010hyd"

```

```

Post__10yr
" 1 1=read/open; 2=write/save"
" 2 1=rainfall; 2=hydrograph"
" 1 1=runoff; 2=inflow; 3=outflow; 4=junction"
" DIV01500.010hyd"
" Major flow at 1500"
" Total volume 11.178 c.m"
" Maximum flow 0.029 c.m/sec"
" 0.029 0.214 0.214 0.000 c.m/sec"
40 HYDROGRAPH Add Runoff "
" 4 Add Runoff "
" 0.029 0.214 0.214 0.000"
33 CATCHMENT 4000"
" 1 Triangular SCS"
" 1 Equal length"
" 1 SCS method"
" 4000 Catchment 4000"
" 0.000 % Impervious"
" 7.330 Total Area"
" 60.000 Flow length"
" 2.000 Overland Slope"
" 7.330 Pervious Area"
" 60.000 Pervious length"
" 2.000 Pervious slope"
" 0.000 Impervious Area"
" 60.000 Impervious length"
" 2.000 Impervious slope"
" 0.250 Pervious Manning 'n'"
" 50.000 Pervious SCS Curve No."
" 0.073 Pervious Runoff coefficient"
" 0.100 Pervious Ia/S coefficient"
" 25.400 Pervious Initial abstraction"
" 0.015 Impervious Manning 'n'"
" 98.000 Impervious SCS Curve No."
" 0.000 Impervious Runoff coefficient"
" 0.100 Impervious Ia/S coefficient"
" 0.518 Impervious Initial abstraction"
" 0.050 0.214 0.214 0.000 c.m/sec"
" Catchment 4000 Pervious Impervious Total Area "
" Surface Area 7.330 0.000 7.330 hectare"
" Time of concentration 57.122 3.114 57.121 minutes"
" Time to Centroid 167.459 88.727 167.458 minutes"
" Rainfall depth 61.359 61.359 61.359 mm"
" Rainfall volume 4497.63 0.00 4497.63 c.m"
" Rainfall losses 56.901 6.470 56.901 mm"
" Runoff depth 4.458 54.890 4.458 mm"
" Runoff volume 326.76 0.00 326.77 c.m"
" Runoff coefficient 0.073 0.000 0.073 "
" Maximum flow 0.050 0.000 0.050 c.m/sec"
40 HYDROGRAPH Add Runoff "
" 4 Add Runoff "
" 0.050 0.263 0.214 0.000"
54 POND DESIGN"
" 0.263 Current peak flow c.m/sec"
" 0.250 Target outflow c.m/sec"
" 4204.5 Hydrograph volume c.m"
" 6. Number of stages"
" 409.630 Minimum water level metre"
" 410.750 Maximum water level metre"
" 409.630 Starting water level metre"
" 0 Keep Design Data: 1 = True; 0 = False"
" Level Discharge Volume"
" 409.630 0.000 0.000"
" 409.750 0.6650 405.300"

```

```

"                                     Post_10yr
"           410.000      3.601  2191.000"
"           410.250      7.811  5322.000"
"           410.500     12.984  9645.400"
"           410.750     18.965 15230.80"
"           Peak outflow                    0.256   c.m/sec"
"           Maximum level                    409.676  metre"
"           Maximum storage                   156.065   c.m"
"           Centroidal lag                    11.563   hours"
"           0.050      0.263      0.256      0.000 c.m/sec"
40  HYDROGRAPH Next link "
"     5 Next link "
"           0.050      0.256      0.256      0.000"
52  CHANNEL DESIGN"
"     0.256 Current peak flow   c.m/sec"
"     0.035 Manning 'n'"
"     0. Cross-section type: 0=trapezoidal; 1=general"
"     0.000 Basewidth   metre"
"     7.410 Left bank slope"
"     6.000 Right bank slope"
"     0.950 Channel depth   metre"
"     1.040 Gradient   %"
"           Depth of flow                    0.235   metre"
"           Velocity                        0.693   m/sec"
"           Channel capacity                 10.655   c.m/sec"
"           Critical depth                   0.197   metre"
53  ROUTE Channel Route 72"
"     72.40 Channel Route 72 Reach length (metre)"
"     0.442 X-factor <= 0.5"
"     78.331 K-lag (seconds)"
"     0.000 Default(0) or user spec.(1) values used"
"     0.500 X-factor <= 0.5"
"     30.000 K-lag (seconds)"
"     0.500 Beta weighting factor"
"     75.000 Routing time step (seconds)"
"     1 No. of sub-reaches"
"           Peak outflow                    0.256   c.m/sec"
"           0.050      0.256      0.256      0.000 c.m/sec"
40  HYDROGRAPH Next link "
"     5 Next link "
"           0.050      0.256      0.256      0.000"
52  CHANNEL DESIGN"
"     0.256 Current peak flow   c.m/sec"
"     0.035 Manning 'n'"
"     0. Cross-section type: 0=trapezoidal; 1=general"
"     2.000 Basewidth   metre"
"     2.950 Left bank slope"
"     3.000 Right bank slope"
"     0.950 Channel depth   metre"
"     1.040 Gradient   %"
"           Depth of flow                    0.146   metre"
"           Velocity                        0.718   m/sec"
"           Channel capacity                 9.246   c.m/sec"
"           Critical depth                   0.112   metre"
53  ROUTE Channel Route 40"
"     39.80 Channel Route 40 Reach length (metre)"
"     0.399 X-factor <= 0.5"
"     41.601 K-lag (seconds)"
"     0.000 Default(0) or user spec.(1) values used"
"     0.500 X-factor <= 0.5"
"     30.000 K-lag (seconds)"
"     0.500 Beta weighting factor"
"     42.857 Routing time step (seconds)"
"     1 No. of sub-reaches"

```

			Post_10yr		
"	Peak outflow		0.255		c.m/sec"
"		0.050	0.256	0.255	0.000 c.m/sec"
" 40	HYDROGRAPH	Combine	100"		
"	6	Combine	"		
"	100	Node #"			
"		Existing wetland"			
"	Maximum flow		0.255		c.m/sec"
"	Hydrograph volume		4204.214		c.m"
"		0.050	0.256	0.255	0.255"
" 40	HYDROGRAPH	Start - New Tributary"			
"	2	Start - New Tributary"			
"		0.050	0.000	0.255	0.255"
" 33	CATCHMENT	2100"			
"	1	Triangular SCS"			
"	1	Equal length"			
"	1	SCS method"			
"	2100	Catchment 2100"			
"	60.000	% Impervious"			
"	1.960	Total Area"			
"	40.000	Flow length"			
"	2.000	Overland Slope"			
"	0.784	Pervious Area"			
"	40.000	Pervious length"			
"	2.000	Pervious slope"			
"	1.176	Impervious Area"			
"	40.000	Impervious length"			
"	2.000	Impervious slope"			
"	0.250	Pervious Manning 'n'"			
"	78.000	Pervious SCS Curve No."			
"	0.380	Pervious Runoff coefficient"			
"	0.100	Pervious Ia/S coefficient"			
"	7.164	Pervious Initial abstraction"			
"	0.015	Impervious Manning 'n'"			
"	98.000	Impervious SCS Curve No."			
"	0.897	Impervious Runoff coefficient"			
"	0.100	Impervious Ia/S coefficient"			
"	0.518	Impervious Initial abstraction"			
"		0.359	0.000	0.255	0.255 c.m/sec"
"	Catchment 2100	Pervious	Impervious	Total Area	"
"	Surface Area	0.784	1.176	1.960	hectare"
"	Time of concentration	19.847	2.441	6.272	minutes"
"	Time to Centroid	118.992	87.742	94.620	minutes"
"	Rainfall depth	61.359	61.359	61.359	mm"
"	Rainfall volume	481.06	721.58	1202.64	c.m"
"	Rainfall losses	38.054	6.310	19.008	mm"
"	Runoff depth	23.305	55.050	42.352	mm"
"	Runoff volume	182.71	647.38	830.09	c.m"
"	Runoff coefficient	0.380	0.897	0.690	"
"	Maximum flow	0.058	0.342	0.359	c.m/sec"
" 40	HYDROGRAPH	Add Runoff "			
"	4	Add Runoff "			
"		0.359	0.359	0.255	0.255"
" 33	CATCHMENT	2400"			
"	1	Triangular SCS"			
"	1	Equal length"			
"	1	SCS method"			
"	2400	Catchment 2400"			
"	90.000	% Impervious"			
"	0.790	Total Area"			
"	20.000	Flow length"			
"	2.000	Overland Slope"			
"	0.079	Pervious Area"			
"	20.000	Pervious length"			

```

Post__10yr
"      2.000 Pervious slope"
"      0.711 Impervious Area"
"     20.000 Impervious length"
"      2.000 Impervious slope"
"      0.250 Pervious Manning 'n'"
"     78.000 Pervious SCS Curve No."
"      0.379 Pervious Runoff coefficient"
"      0.100 Pervious Ia/S coefficient"
"      7.164 Pervious Initial abstraction"
"      0.015 Impervious Manning 'n'"
"     98.000 Impervious SCS Curve No."
"      0.901 Impervious Runoff coefficient"
"      0.100 Impervious Ia/S coefficient"
"      0.518 Impervious Initial abstraction"
"          0.205      0.359      0.255      0.255 c.m/sec"
"      Catchment 2400 Pervious Impervious Total Area "
"      Surface Area      0.079      0.711      0.790 hectare"
"      Time of concentration 13.094      1.611      2.123 minutes"
"      Time to Centroid 111.234      86.563      87.664 minutes"
"      Rainfall depth      61.359      61.359      61.359 mm"
"      Rainfall volume      48.47      436.26      484.74 c.m"
"      Rainfall losses      38.098      6.044      9.250 mm"
"      Runoff depth      23.262      55.315      52.110 mm"
"      Runoff volume      18.38      393.29      411.67 c.m"
"      Runoff coefficient      0.379      0.901      0.849 "
"      Maximum flow      0.007      0.204      0.205 c.m/sec"
40 HYDROGRAPH Add Runoff "
"      4 Add Runoff "
"          0.205      0.565      0.255      0.255"
54 POND DESIGN"
"      0.565 Current peak flow c.m/sec"
"      0.020 Target outflow c.m/sec"
"     1241.8 Hydrograph volume c.m"
"      13. Number of stages"
"     410.650 Minimum water level metre"
"     411.950 Maximum water level metre"
"     410.650 Starting water level metre"
"      0 Keep Design Data: 1 = True; 0 = False"
"          Level Discharge Volume"
"     410.650      0.000      0.000"
"     410.700      0.00600      42.000"
"     410.800      0.01300      130.000"
"     410.900      0.02000      225.000"
"     411.000      0.02500      328.000"
"     411.100      0.02900      439.000"
"     411.200      0.1260      558.000"
"     411.300      0.1390      686.000"
"     411.400      0.1510      822.000"
"     411.500      0.1630      967.000"
"     411.600      0.1730     1121.000"
"     411.650      0.1780     1202.000"
"     411.950      2.575     1742.000"
"      Peak outflow      0.139 c.m/sec"
"      Maximum level      411.304 metre"
"      Maximum storage      690.969 c.m"
"      Centroidal lag      3.683 hours"
"          0.205      0.565      0.139      0.255 c.m/sec"
40 HYDROGRAPH Next link "
"      5 Next link "
"          0.205      0.139      0.139      0.255"
33 CATCHMENT 2300"
"      1 Triangular SCS"
"      1 Equal length"

```

```

"      1 SCS method"
"      2300 Catchment 2300"
"     10.000 % Impervious"
"      0.480 Total Area"
"     20.000 Flow length"
"      2.000 Overland Slope"
"      0.432 Pervious Area"
"     20.000 Pervious length"
"      2.000 Pervious slope"
"      0.048 Impervious Area"
"     20.000 Impervious length"
"      2.000 Impervious slope"
"      0.250 Pervious Manning 'n'"
"     78.000 Pervious SCS Curve No."
"      0.379 Pervious Runoff coefficient"
"      0.100 Pervious Ia/S coefficient"
"      7.164 Pervious Initial abstraction"
"      0.015 Impervious Manning 'n'"
"     98.000 Impervious SCS Curve No."
"      0.901 Impervious Runoff coefficient"
"      0.100 Impervious Ia/S coefficient"
"      0.518 Impervious Initial abstraction"
"          0.045      0.139      0.139      0.255 c.m/sec"
"      Catchment 2300      Pervious      Impervious      Total Area      "
"      Surface Area      0.432      0.048      0.480      hectare"
"      Time of concentration      13.094      1.611      10.694      minutes"
"      Time to Centroid      111.234      86.563      106.078      minutes"
"      Rainfall depth      61.359      61.359      61.359      mm"
"      Rainfall volume      265.07      29.45      294.52      c.m"
"      Rainfall losses      38.098      6.044      34.892      mm"
"      Runoff depth      23.262      55.315      26.467      mm"
"      Runoff volume      100.49      26.55      127.04      c.m"
"      Runoff coefficient      0.379      0.901      0.431      "
"      Maximum flow      0.039      0.014      0.045      c.m/sec"
" 40      HYDROGRAPH Add Runoff "
"      4      Add Runoff "
"          0.045      0.177      0.139      0.255"
" 40      HYDROGRAPH Copy to Outflow"
"      8      Copy to Outflow"
"          0.045      0.177      0.177      0.255"
" 40      HYDROGRAPH Combine 200"
"      6      Combine "
"     200      Node #"
"          To Trib. of Grand River"
"      Maximum flow      0.177      c.m/sec"
"      Hydrograph volume      1368.391      c.m"
"          0.045      0.177      0.177      0.177"
" 40      HYDROGRAPH Start - New Tributary"
"      2      Start - New Tributary"
"          0.045      0.000      0.177      0.177"
" 33      CATCHMENT 2200"
"      1      Triangular SCS"
"      1      Equal length"
"      1      SCS method"
"     2200      Catchment 2200"
"     75.000      % Impervious"
"      0.920      Total Area"
"     40.000      Flow length"
"      2.000      Overland Slope"
"      0.230      Pervious Area"
"     40.000      Pervious length"
"      2.000      Pervious slope"
"      0.690      Impervious Area"

```

```

Post__10yr
" 40.000 Impervious length"
" 2.000 Impervious slope"
" 0.250 Pervious Manning 'n'"
" 78.000 Pervious SCS Curve No."
" 0.380 Pervious Runoff coefficient"
" 0.100 Pervious Ia/S coefficient"
" 7.164 Pervious Initial abstraction"
" 0.015 Impervious Manning 'n'"
" 98.000 Impervious SCS Curve No."
" 0.897 Impervious Runoff coefficient"
" 0.100 Impervious Ia/S coefficient"
" 0.518 Impervious Initial abstraction"
" 0.206 0.000 0.177 0.177 c.m/sec"
" Catchment 2200 Pervious Impervious Total Area "
" Surface Area 0.230 0.690 0.920 hectare"
" Time of concentration 19.847 2.441 4.594 minutes"
" Time to Centroid 118.992 87.742 91.606 minutes"
" Rainfall depth 61.359 61.359 61.359 mm"
" Rainfall volume 141.13 423.38 564.51 c.m"
" Rainfall losses 38.054 6.310 14.246 mm"
" Runoff depth 23.305 55.050 47.113 mm"
" Runoff volume 53.60 379.84 433.44 c.m"
" Runoff coefficient 0.380 0.897 0.768 "
" Maximum flow 0.017 0.201 0.206 c.m/sec"
40 HYDROGRAPH Add Runoff "
4 Add Runoff "
" 0.206 0.206 0.177 0.177"
54 POND DESIGN"
0.206 Current peak flow c.m/sec"
0.756 Target outflow c.m/sec"
433.4 Hydrograph volume c.m"
12. Number of stages"
413.700 Minimum water level metre"
415.000 Maximum water level metre"
413.700 Starting water level metre"
0 Keep Design Data: 1 = True; 0 = False"
Level Discharge volume"
413.700 0.000 0.000"
413.800 0.00500 88.600"
413.900 0.01000 187.200"
414.000 0.01300 298.400"
414.100 0.01500 422.200"
414.200 0.2220 558.900"
414.300 0.2590 708.500"
414.400 0.2910 871.100"
414.500 0.3210 1046.900"
414.600 0.3470 1236.100"
414.700 0.3720 1438.700"
415.000 2.808 2087.400"
Peak outflow 0.014 c.m/sec"
Maximum level 414.033 metre"
Maximum storage 338.951 c.m"
Centroidal lag 7.231 hours"
0.206 0.206 0.014 0.177 c.m/sec"
40 HYDROGRAPH Combine 200"
6 Combine "
200 Node #"
To Trib. of Grand River"
Maximum flow 0.189 c.m/sec"
Hydrograph volume 1801.834 c.m"
0.206 0.206 0.014 0.189"
40 HYDROGRAPH Start - New Tributary"
2 Start - New Tributary"

```

			Post_10yr		
"	0.206	0.000	0.014	0.189"	
" 33	CATCHMENT 3200"				
"	1	Triangular SCS"			
"	1	Equal length"			
"	1	SCS method"			
"	3200	Catchment 3200"			
"	60.000	% Impervious"			
"	0.530	Total Area"			
"	40.000	Flow length"			
"	1.000	Overland Slope"			
"	0.212	Pervious Area"			
"	40.000	Pervious length"			
"	1.000	Pervious slope"			
"	0.318	Impervious Area"			
"	40.000	Impervious length"			
"	1.000	Impervious slope"			
"	0.250	Pervious Manning 'n'"			
"	78.000	Pervious SCS Curve No."			
"	0.380	Pervious Runoff coefficient"			
"	0.100	Pervious Ia/S coefficient"			
"	7.164	Pervious Initial abstraction"			
"	0.015	Impervious Manning 'n'"			
"	98.000	Impervious SCS Curve No."			
"	0.895	Impervious Runoff coefficient"			
"	0.100	Impervious Ia/S coefficient"			
"	0.518	Impervious Initial abstraction"			
"	0.098	0.000	0.014	0.189 c.m/sec"	
"	Catchment 3200	Pervious	Impervious	Total Area	"
"	Surface Area	0.212	0.318	0.530	hectare"
"	Time of concentration	24.434	3.005	7.732	minutes"
"	Time to Centroid	124.292	88.564	96.444	minutes"
"	Rainfall depth	61.359	61.359	61.359	mm"
"	Rainfall volume	130.08	195.12	325.20	c.m"
"	Rainfall losses	38.047	6.437	19.081	mm"
"	Runoff depth	23.312	54.922	42.278	mm"
"	Runoff volume	49.42	174.65	224.07	c.m"
"	Runoff coefficient	0.380	0.895	0.689	"
"	Maximum flow	0.014	0.095	0.098	c.m/sec"
" 40	HYDROGRAPH Add Runoff "				
"	4	Add Runoff "			
"	0.098	0.098	0.014	0.189"	
" 33	CATCHMENT 3300"				
"	1	Triangular SCS"			
"	1	Equal length"			
"	1	SCS method"			
"	3300	Catchment 3300"			
"	60.000	% Impervious"			
"	0.240	Total Area"			
"	20.000	Flow length"			
"	2.000	Overland Slope"			
"	0.096	Pervious Area"			
"	20.000	Pervious length"			
"	2.000	Pervious slope"			
"	0.144	Impervious Area"			
"	20.000	Impervious length"			
"	2.000	Impervious slope"			
"	0.250	Pervious Manning 'n'"			
"	78.000	Pervious SCS Curve No."			
"	0.379	Pervious Runoff coefficient"			
"	0.100	Pervious Ia/S coefficient"			
"	7.164	Pervious Initial abstraction"			
"	0.015	Impervious Manning 'n'"			
"	98.000	Impervious SCS Curve No."			

			Post_10yr		
"	0.901	Impervious Runoff coefficient"			
"	0.100	Impervious Ia/S coefficient"			
"	0.518	Impervious Initial abstraction"			
"		0.045	0.098	0.014	0.189 c.m/sec"
"		Catchment 3300	Pervious	Impervious	Total Area "
"		Surface Area	0.096	0.144	0.240 hectare"
"		Time of concentration	13.094	1.611	4.125 minutes"
"		Time to Centroid	111.234	86.563	91.965 minutes"
"		Rainfall depth	61.359	61.359	61.359 mm"
"		Rainfall volume	58.90	88.36	147.26 c.m"
"		Rainfall losses	38.097	6.044	18.866 mm"
"		Runoff depth	23.262	55.315	42.494 mm"
"		Runoff volume	22.33	79.65	101.98 c.m"
"		Runoff coefficient	0.379	0.901	0.693 "
"		Maximum flow	0.009	0.041	0.045 c.m/sec"
" 40		HYDROGRAPH Add Runoff "			
"	4	Add Runoff "			
"		0.045	0.143	0.014	0.189"
" 40		HYDROGRAPH Copy to Outflow"			
"	8	Copy to Outflow"			
"		0.045	0.143	0.143	0.189"
" 40		HYDROGRAPH Combine 300"			
"	6	Combine "			
"	300	Node #"			
"		To Walser Street"			
"		Maximum flow	0.143		c.m/sec"
"		Hydrograph volume	326.058		c.m"
"		0.045	0.143	0.143	0.143"
" 40		HYDROGRAPH Confluence 300"			
"	7	Confluence "			
"	300	Node #"			
"		To Walser Street"			
"		Maximum flow	0.143		c.m/sec"
"		Hydrograph volume	326.058		c.m"
"		0.045	0.143	0.143	0.000"
" 40		HYDROGRAPH Copy to Outflow"			
"	8	Copy to Outflow"			
"		0.045	0.143	0.143	0.000"
" 40		HYDROGRAPH Combine 100"			
"	6	Combine "			
"	100	Node #"			
"		Existing wetland"			
"		Maximum flow	0.268		c.m/sec"
"		Hydrograph volume	4530.272		c.m"
"		0.045	0.143	0.143	0.268"
" 40		HYDROGRAPH Confluence 100"			
"	7	Confluence "			
"	100	Node #"			
"		Existing wetland"			
"		Maximum flow	0.268		c.m/sec"
"		Hydrograph volume	4530.272		c.m"
"		0.045	0.268	0.143	0.000"
" 40		HYDROGRAPH Copy to Outflow"			
"	8	Copy to Outflow"			
"		0.045	0.268	0.268	0.000"
" 40		HYDROGRAPH Combine 200"			
"	6	Combine "			
"	200	Node #"			
"		To Trib. of Grand River"			
"		Maximum flow	0.414		c.m/sec"
"		Hydrograph volume	6332.119		c.m"
"		0.045	0.268	0.268	0.414"
" 40		HYDROGRAPH Confluence 200"			

```

"                               Post__10yr
"       7  Confluence "
"       200 Node #"
"           To Trib. of Grand River"
"           Maximum flow           0.414    c.m/sec"
"           Hydrograph volume      6332.119 c.m"
"           0.045    0.414    0.268    0.000"
" 38  START/RE-START TOTALS 200"
"       3  Runoff Totals on EXIT"
"           Total Catchment area           22.640  hectare"
"           Total Impervious area          7.856  hectare"
"           Total % impervious           34.700"
" 19  EXIT"

```

```

"                                     Post__25yr
"
" MIDUSS Output ----->"
" MIDUSS version                      Version 2.25 rev. 473"
" MIDUSS created                      Sunday, February 07, 2010"
" 10 Units used:                      ie METRIC"
" Job folder:                        w:\Kitchener\411-2011\411009\Design Data\
"                                     Modelling Files\2019-02-15"
" Output filename:                    Post__25yr.out"
" Licensee name:                      gmbp"
" Company                             Hewlett-Packard Company"
" Date & Time last used:              2/15/2019 at 3:54:57 PM"
" 31 TIME PARAMETERS"
" 5.000 Time Step"
" 180.000 Max. Storm length"
" 12000.000 Max. Hydrograph"
" 32 STORM Chicago storm"
" 1 Chicago storm"
" 3701.648 Coefficient A"
" 25.500 Constant B"
" 0.937 Exponent C"
" 0.380 Fraction R"
" 180.000 Duration"
" 1.000 Time step multiplier"
" Maximum intensity                    143.371 mm/hr"
" Total depth                          75.581 mm"
" 6 025hyd Hydrograph extension used in this file"
" 33 CATCHMENT 1200"
" 1 Triangular SCS"
" 1 Equal length"
" 1 SCS method"
" 1200 Catchment 1200"
" 50.000 % Impervious"
" 0.220 Total Area"
" 10.000 Flow length"
" 2.000 Overland slope"
" 0.110 Pervious Area"
" 10.000 Pervious length"
" 2.000 Pervious slope"
" 0.110 Impervious Area"
" 10.000 Impervious length"
" 2.000 Impervious slope"
" 0.250 Pervious Manning 'n'"
" 78.000 Pervious SCS Curve No."
" 0.440 Pervious Runoff coefficient"
" 0.100 Pervious Ia/S coefficient"
" 7.164 Pervious Initial abstraction"
" 0.015 Impervious Manning 'n'"
" 98.000 Impervious SCS Curve No."
" 0.899 Impervious Runoff coefficient"
" 0.100 Impervious Ia/S coefficient"
" 0.518 Impervious Initial abstraction"
" 0.047 0.000 0.000 0.000 c.m/sec"
" Catchment 1200 Pervious Impervious Total Area "
" Surface Area 0.110 0.110 0.220 hectare"
" Time of concentration 7.622 1.005 3.181 minutes"
" Time to Centroid 103.628 85.398 91.394 minutes"
" Rainfall depth 75.581 75.581 75.581 mm"
" Rainfall volume 83.14 83.14 166.28 c.m"
" Rainfall losses 42.296 7.669 24.982 mm"
" Runoff depth 33.285 67.912 50.598 mm"
" Runoff volume 36.61 74.70 111.32 c.m"
" Runoff coefficient 0.440 0.899 0.669 "
" Maximum flow 0.018 0.038 0.047 c.m/sec"
" 40 HYDROGRAPH Add Runoff "

```



```

"          4  Add Runoff "
"          0.047      0.047      0.000      0.000"
" 33  CATCHMENT 1300"
"      1  Triangular SCS"
"      1  Equal length"
"      1  SCS method"
"      1300  Catchment 1300"
"      50.000  % Impervious"
"      0.840  Total Area"
"      20.000  Flow length"
"      2.000  Overland Slope"
"      0.420  Pervious Area"
"      20.000  Pervious length"
"      2.000  Pervious slope"
"      0.420  Impervious Area"
"      20.000  Impervious length"
"      2.000  Impervious slope"
"      0.250  Pervious Manning 'n'"
"      78.000  Pervious SCS Curve No."
"      0.441  Pervious Runoff coefficient"
"      0.100  Pervious Ia/S coefficient"
"      7.164  Pervious Initial abstraction"
"      0.015  Impervious Manning 'n'"
"      98.000  Impervious SCS Curve No."
"      0.916  Impervious Runoff coefficient"
"      0.100  Impervious Ia/S coefficient"
"      0.518  Impervious Initial abstraction"
"          0.173      0.047      0.000      0.000 c.m/sec"
"      Catchment 1300      Pervious      Impervious      Total Area "
"      Surface Area      0.420      0.420      0.840      hectare"
"      Time of concentration      11.553      1.523      4.782      minutes"
"      Time to Centroid      108.042      85.984      93.151      minutes"
"      Rainfall depth      75.581      75.581      75.581      mm"
"      Rainfall volume      317.44      317.44      634.88      c.m"
"      Rainfall losses      42.253      6.330      24.292      mm"
"      Runoff depth      33.328      69.250      51.289      mm"
"      Runoff volume      139.98      290.85      430.83      c.m"
"      Runoff coefficient      0.441      0.916      0.679      "
"      Maximum flow      0.057      0.142      0.173      c.m/sec"
" 40  HYDROGRAPH Add Runoff "
"      4  Add Runoff "
"          0.173      0.220      0.000      0.000"
" 33  CATCHMENT 1600"
"      1  Triangular SCS"
"      1  Equal length"
"      1  SCS method"
"      1600  Catchment 1600"
"      50.000  % Impervious"
"      0.360  Total Area"
"      15.000  Flow length"
"      2.000  Overland Slope"
"      0.180  Pervious Area"
"      15.000  Pervious length"
"      2.000  Pervious slope"
"      0.180  Impervious Area"
"      15.000  Impervious length"
"      2.000  Impervious slope"
"      0.250  Pervious Manning 'n'"
"      78.000  Pervious SCS Curve No."
"      0.439  Pervious Runoff coefficient"
"      0.100  Pervious Ia/S coefficient"
"      7.164  Pervious Initial abstraction"
"      0.015  Impervious Manning 'n'"

```

```

"                                     Post__25yr
" 98.000 Impervious SCS Curve No."
" 0.912 Impervious Runoff coefficient"
" 0.100 Impervious Ia/S coefficient"
" 0.518 Impervious Initial abstraction"
"           0.076      0.220      0.000      0.000 c.m/sec"
" Catchment 1600 Pervious Impervious Total Area "
" Surface Area 0.180 0.180 0.360 hectare"
" Time of concentration 9.721 1.281 4.026 minutes"
" Time to Centroid 106.001 85.673 92.284 minutes"
" Rainfall depth 75.581 75.581 75.581 mm"
" Rainfall volume 136.05 136.05 272.09 c.m"
" Rainfall losses 42.377 6.681 24.529 mm"
" Runoff depth 33.204 68.900 51.052 mm"
" Runoff volume 59.77 124.02 183.79 c.m"
" Runoff coefficient 0.439 0.912 0.675 "
" Maximum flow 0.026 0.061 0.076 c.m/sec"
" 40 HYDROGRAPH Add Runoff "
" 4 Add Runoff "
"           0.076      0.296      0.000      0.000"
" 54 POND DESIGN"
" 0.296 Current peak flow c.m/sec"
" 0.250 Target outflow c.m/sec"
" 725.9 Hydrograph volume c.m"
" 16. Number of stages"
" 411.830 Minimum water level metre"
" 414.490 Maximum water level metre"
" 411.830 Starting water level metre"
" 0 Keep Design Data: 1 = True; 0 = False"
" Level Discharge Volume"
" 411.830 0.00033 0.000"
" 411.930 0.00033 19.920"
" 412.230 0.00034 143.570"
" 412.530 0.00035 267.220"
" 412.630 0.00035 287.130"
" 412.700 0.00035 301.070"
" 412.800 0.00035 301.140"
" 413.000 0.00035 301.260"
" 413.230 0.00035 301.400"
" 413.430 0.04510 301.740"
" 413.630 0.1310 302.400"
" 413.830 0.2461 303.400"
" 414.030 0.3862 304.740"
" 414.090 0.4327 305.240"
" 414.290 0.6461 307.240"
" 414.490 0.9189 309.570"
" Peak outflow 0.254 c.m/sec"
" Maximum level 413.850 metre"
" Maximum storage 303.535 c.m"
" Centroidal lag 42.727 hours"
"           0.076      0.296      0.254      0.000 c.m/sec"
" 40 HYDROGRAPH Combine 1"
" 6 Combine "
" 1 Node #"
" Outlets to SWMF No. 1"
" Maximum flow 0.254 c.m/sec"
" Hydrograph volume 699.254 c.m"
"           0.076      0.296      0.254      0.254"
" 40 HYDROGRAPH Start - New Tributary"
" 2 Start - New Tributary"
"           0.076      0.000      0.254      0.254"
" 33 CATCHMENT 1400"
" 1 Triangular SCS"
" 1 Equal length"

```

Post__25yr

```

"      1  SCS method"
"      1400 Catchment 1400"
"      20.000 % Impervious"
"      0.620 Total Area"
"      30.000 Flow length"
"      2.000 Overland Slope"
"      0.496 Pervious Area"
"      30.000 Pervious length"
"      2.000 Pervious slope"
"      0.124 Impervious Area"
"      30.000 Impervious length"
"      2.000 Impervious slope"
"      0.250 Pervious Manning 'n'"
"      78.000 Pervious SCS Curve No."
"      0.441 Pervious Runoff coefficient"
"      0.100 Pervious Ia/S coefficient"
"      7.164 Pervious Initial abstraction"
"      0.015 Impervious Manning 'n'"
"      98.000 Impervious SCS Curve No."
"      0.916 Impervious Runoff coefficient"
"      0.100 Impervious Ia/S coefficient"
"      0.518 Impervious Initial abstraction"
"      0.082 0.000 0.254 0.254 c.m/sec"
"      Catchment 1400 Pervious Impervious Total Area "
"      Surface Area 0.496 0.124 0.620 hectare"
"      Time of concentration 14.734 1.942 10.366 minutes"
"      Time to Centroid 111.700 86.497 103.093 minutes"
"      Rainfall depth 75.581 75.581 75.581 mm"
"      Rainfall volume 374.88 93.72 468.60 c.m"
"      Rainfall losses 42.213 6.364 35.043 mm"
"      Runoff depth 33.368 69.217 40.538 mm"
"      Runoff volume 165.50 85.83 251.33 c.m"
"      Runoff coefficient 0.441 0.916 0.536 "
"      Maximum flow 0.061 0.042 0.082 c.m/sec"
" 40 HYDROGRAPH Add Runoff "
"      4 Add Runoff "
"      0.082 0.082 0.254 0.254"
" 54 POND DESIGN"
"      0.082 Current peak flow c.m/sec"
"      0.250 Target outflow c.m/sec"
"      251.3 Hydrograph volume c.m"
"      17. Number of stages"
"      413.920 Minimum water level metre"
"      415.520 Maximum water level metre"
"      413.920 Starting water level metre"
"      0 Keep Design Data: 1 = True; 0 = False"
"      Level Discharge Volume"
"      413.920 0.00089 0.000"
"      414.020 0.00089 26.670"
"      414.120 0.00090 54.610"
"      414.220 0.00090 82.540"
"      414.320 0.00090 110.480"
"      414.420 0.00091 138.420"
"      414.520 0.00091 165.090"
"      414.620 0.00091 191.760"
"      414.720 0.00091 191.830"
"      414.820 0.02640 191.900"
"      414.920 0.03734 191.970"
"      415.020 0.04573 192.040"
"      415.120 0.05281 192.120"
"      415.220 0.2777 201.400"
"      415.320 0.6941 238.900"
"      415.420 1.244 304.650"

```

			Post__25yr		
"	415.520	1.909	382.150"		
"	Peak outflow		0.017	c.m/sec"	
"	Maximum level		414.825	metre"	
"	Maximum storage		191.904	c.m"	
"	Centroidal lag		26.818	hours"	
"	0.082	0.082	0.017	0.254	c.m/sec"
40	HYDROGRAPH Next link "				
"	5 Next link "				
"	0.082	0.017	0.017	0.254"	
33	CATCHMENT 1500"				
"	1 Triangular SCS"				
"	1 Equal length"				
"	1 SCS method"				
"	1500 Catchment 1500"				
"	50.000 % Impervious"				
"	1.110 Total Area"				
"	40.000 Flow length"				
"	2.000 Overland Slope"				
"	0.555 Pervious Area"				
"	40.000 Pervious length"				
"	2.000 Pervious slope"				
"	0.555 Impervious Area"				
"	40.000 Impervious length"				
"	2.000 Impervious slope"				
"	0.250 Pervious Manning 'n'"				
"	78.000 Pervious SCS Curve No."				
"	0.442 Pervious Runoff coefficient"				
"	0.100 Pervious Ia/S coefficient"				
"	7.164 Pervious Initial abstraction"				
"	0.015 Impervious Manning 'n'"				
"	98.000 Impervious SCS Curve No."				
"	0.913 Impervious Runoff coefficient"				
"	0.100 Impervious Ia/S coefficient"				
"	0.518 Impervious Initial abstraction"				
"	0.213	0.017	0.017	0.254	c.m/sec"
"	Catchment 1500	Pervious	Impervious	Total Area	"
"	Surface Area	0.555	0.555	1.110	hectare"
"	Time of concentration	17.510	2.308	7.265	minutes"
"	Time to Centroid	114.842	87.059	96.118	minutes"
"	Rainfall depth	75.581	75.581	75.581	mm"
"	Rainfall volume	419.47	419.47	838.95	c.m"
"	Rainfall losses	42.200	6.593	24.396	mm"
"	Runoff depth	33.381	68.988	51.185	mm"
"	Runoff volume	185.27	382.88	568.15	c.m"
"	Runoff coefficient	0.442	0.913	0.677	"
"	Maximum flow	0.064	0.190	0.213	c.m/sec"
40	HYDROGRAPH Add Runoff "				
"	4 Add Runoff "				
"	0.213	0.214	0.017	0.254"	
56	DIVERSION"				
"	1500 Node number"				
"	0.146 Overflow threshold"				
"	1.000 Required diverted fraction"				
"	0 Conduit type; 1=Pipe;2=Channel"				
"	Peak of diverted flow		0.068	c.m/sec"	
"	Volume of diverted flow		47.127	c.m"	
"	DIV01500.025hyd"				
"	Major flow at 1500"				
"	0.213	0.214	0.146	0.254	c.m/sec"
40	HYDROGRAPH Next link "				
"	5 Next link "				
"	0.213	0.146	0.146	0.254"	
33	CATCHMENT 1000"				

```

"      1 Triangular SCS"
"      1 Equal length"
"      1 SCS method"
"    1000 Catchment 1000"
"    50.000 % Impervious"
"     6.760 Total Area"
"   100.000 Flow length"
"     2.000 Overland Slope"
"     3.380 Pervious Area"
"   100.000 Pervious length"
"     2.000 Pervious slope"
"     3.380 Impervious Area"
"   100.000 Impervious length"
"     2.000 Impervious slope"
"     0.250 Pervious Manning 'n'"
"    78.000 Pervious SCS Curve No."
"     0.442 Pervious Runoff coefficient"
"     0.100 Pervious Ia/S coefficient"
"     7.164 Pervious Initial abstraction"
"     0.015 Impervious Manning 'n'"
"   98.000 Impervious SCS Curve No."
"     0.917 Impervious Runoff coefficient"
"     0.100 Impervious Ia/S coefficient"
"     0.518 Impervious Initial abstraction"
"           1.251     0.146     0.146     0.254 c.m/sec"
"   Catchment 1000      Pervious      Impervious      Total Area  "
"   Surface Area      3.380      3.380      6.760      hectare"
"   Time of concentration  30.343      4.000      12.568      minutes"
"   Time to Centroid    129.499      89.355      102.412      minutes"
"   Rainfall depth      75.581      75.581      75.581      mm"
"   Rainfall volume     2554.63      2554.63      5109.27      c.m"
"   Rainfall losses     42.180      6.290      24.235      mm"
"   Runoff depth        33.401      69.291      51.346      mm"
"   Runoff volume       1128.94      2342.03      3470.97      c.m"
"   Runoff coefficient   0.442      0.917      0.679      "
"   Maximum flow       0.289      1.196      1.251      c.m/sec"
" 40 HYDROGRAPH Add Runoff "
"     4 Add Runoff "
"           1.251     1.397     0.146     0.254"
" 33 CATCHMENT 1100"
"     1 Triangular SCS"
"     1 Equal length"
"     1 SCS method"
"    1100 Catchment 1100"
"     0.000 % Impervious"
"     0.480 Total Area"
"    20.000 Flow length"
"     2.000 Overland Slope"
"     0.480 Pervious Area"
"    20.000 Pervious length"
"     2.000 Pervious slope"
"     0.000 Impervious Area"
"    20.000 Impervious length"
"     2.000 Impervious slope"
"     0.250 Pervious Manning 'n'"
"    78.000 Pervious SCS Curve No."
"     0.441 Pervious Runoff coefficient"
"     0.100 Pervious Ia/S coefficient"
"     7.164 Pervious Initial abstraction"
"     0.015 Impervious Manning 'n'"
"   98.000 Impervious SCS Curve No."
"     0.000 Impervious Runoff coefficient"
"     0.100 Impervious Ia/S coefficient"

```

```

"          Post__25yr
" 0.518  Impervious Initial abstraction"
"          0.065      1.397      0.146      0.254 c.m/sec"
"          Catchment 1100 Pervious Impervious Total Area "
"          Surface Area      0.480      0.000      0.480      hectare"
"          Time of concentration 11.553      1.523      11.553      minutes"
"          Time to Centroid      108.042      85.984      108.042      minutes"
"          Rainfall depth      75.581      75.581      75.581      mm"
"          Rainfall volume      362.79      0.00      362.79      c.m"
"          Rainfall losses      42.253      6.330      42.253      mm"
"          Runoff depth      33.328      69.250      33.328      mm"
"          Runoff volume      159.97      0.00      159.98      c.m"
"          Runoff coefficient      0.441      0.000      0.441      "
"          Maximum flow      0.065      0.000      0.065      c.m/sec"
" 40  HYDROGRAPH Add Runoff "
" 4  Add Runoff "
"          0.065      1.435      0.146      0.254"
" 40  HYDROGRAPH Copy to Outflow"
" 8  Copy to Outflow"
"          0.065      1.435      1.435      0.254"
" 40  HYDROGRAPH Combine 1"
" 6  Combine "
" 1  Node #"
"      Outlets to SWMF No. 1"
"          Maximum flow      1.436      c.m/sec"
"          Hydrograph volume      5100.042      c.m"
"          0.065      1.435      1.435      1.436"
" 40  HYDROGRAPH Confluence 1"
" 7  Confluence "
" 1  Node #"
"      Outlets to SWMF No. 1"
"          Maximum flow      1.436      c.m/sec"
"          Hydrograph volume      5100.043      c.m"
"          0.065      1.436      1.435      0.000"
" 54  POND DESIGN"
" 1.436  Current peak flow      c.m/sec"
" 0.250  Target outflow      c.m/sec"
" 5100.0  Hydrograph volume      c.m"
" 11.    Number of stages"
" 411.000  Minimum water level      metre"
" 412.000  Maximum water level      metre"
" 411.000  Starting water level      metre"
" 0  Keep Design Data: 1 = True; 0 = False"
"      Level Discharge      volume"
" 411.000      0.000      0.000"
" 411.100      0.05100      425.000"
" 411.200      0.1030      936.000"
" 411.300      0.1190      1459.000"
" 411.400      0.1330      1994.000"
" 411.500      0.3220      2542.000"
" 411.600      0.3510      3101.000"
" 411.700      0.3780      3673.000"
" 411.800      0.4030      4258.000"
" 411.850      0.4150      4554.000"
" 412.000      2.088      5464.000"
"          Peak outflow      0.337      c.m/sec"
"          Maximum level      411.553      metre"
"          Maximum storage      2841.060      c.m"
"          Centroidal lag      10.225      hours"
"          0.065      1.436      0.337      0.000 c.m/sec"
" 40  HYDROGRAPH Next link "
" 5  Next link "
"          0.065      0.337      0.337      0.000"
" 47  FILEI_0 Read/Open DIV01500.025hyd"

```

```

Post__25yr
" 1 1=read/open; 2=write/save"
" 2 1=rainfall; 2=hydrograph"
" 1 1=runoff; 2=inflow; 3=outflow; 4=junction"
" DIV01500.025hyd"
" Major flow at 1500"
" Total volume 47.127 c.m"
" Maximum flow 0.068 c.m/sec"
" 0.068 0.337 0.337 0.000 c.m/sec"
40 HYDROGRAPH Add Runoff "
" 4 Add Runoff "
" 0.068 0.337 0.337 0.000"
33 CATCHMENT 4000"
" 1 Triangular SCS"
" 1 Equal length"
" 1 SCS method"
" 4000 Catchment 4000"
" 0.000 % Impervious"
" 7.330 Total Area"
" 60.000 Flow length"
" 2.000 Overland Slope"
" 7.330 Pervious Area"
" 60.000 Pervious length"
" 2.000 Pervious slope"
" 0.000 Impervious Area"
" 60.000 Impervious length"
" 2.000 Impervious slope"
" 0.250 Pervious Manning 'n'"
" 50.000 Pervious SCS Curve No."
" 0.109 Pervious Runoff coefficient"
" 0.100 Pervious Ia/S coefficient"
" 25.400 Pervious Initial abstraction"
" 0.015 Impervious Manning 'n'"
" 98.000 Impervious SCS Curve No."
" 0.000 Impervious Runoff coefficient"
" 0.100 Impervious Ia/S coefficient"
" 0.518 Impervious Initial abstraction"
" 0.114 0.337 0.337 0.000 c.m/sec"
" Catchment 4000 Pervious Impervious Total Area "
" Surface Area 7.330 0.000 7.330 hectare"
" Time of concentration 43.720 2.944 43.719 minutes"
" Time to Centroid 151.037 87.974 151.037 minutes"
" Rainfall depth 75.581 75.581 75.581 mm"
" Rainfall volume 5540.07 0.01 5540.08 c.m"
" Rainfall losses 67.305 6.942 67.305 mm"
" Runoff depth 8.276 68.639 8.276 mm"
" Runoff volume 606.62 0.01 606.62 c.m"
" Runoff coefficient 0.109 0.000 0.109 "
" Maximum flow 0.114 0.000 0.114 c.m/sec"
40 HYDROGRAPH Add Runoff "
" 4 Add Runoff "
" 0.114 0.449 0.337 0.000"
54 POND DESIGN"
" 0.449 Current peak flow c.m/sec"
" 0.250 Target outflow c.m/sec"
" 5750.0 Hydrograph volume c.m"
" 6. Number of stages"
" 409.630 Minimum water level metre"
" 410.750 Maximum water level metre"
" 409.630 Starting water level metre"
" 0 Keep Design Data: 1 = True; 0 = False"
" Level Discharge Volume"
" 409.630 0.000 0.000"
" 409.750 0.6650 402.200"

```

```

"                                     Post__25yr
"           410.000      3.601  2187.900"
"           410.250      7.811  5318.900"
"           410.500     12.984  9642.300"
"           410.750     18.965 15227.70"
"           Peak outflow                0.437   c.m/sec"
"           Maximum level                409.709  metre"
"           Maximum storage              264.461   c.m"
"           Centroidal lag                9.500   hours"
"           0.114      0.449      0.437      0.000 c.m/sec"
" 40           HYDROGRAPH Next link "
"           5 Next link "
"           0.114      0.437      0.437      0.000"
" 52           CHANNEL DESIGN"
"           0.437 Current peak flow      c.m/sec"
"           0.035 Manning 'n'"
"           0. Cross-section type: 0=trapezoidal; 1=general"
"           0.000 Basewidth      metre"
"           7.410 Left bank slope"
"           6.000 Right bank slope"
"           0.950 Channel depth      metre"
"           1.040 Gradient      %"
"           Depth of flow                0.287   metre"
"           Velocity                    0.792   m/sec"
"           Channel capacity              10.655  c.m/sec"
"           Critical depth                0.244   metre"
" 53           ROUTE Channel Route 72"
"           72.40 Channel Route 72 Reach length (metre)"
"           0.429 X-factor <= 0.5"
"           68.529 K-lag (seconds)"
"           0.000 Default(0) or user spec.(1) values used"
"           0.500 X-factor <= 0.5"
"           30.000 K-lag (seconds)"
"           0.500 Beta weighting factor"
"           75.000 Routing time step (seconds)"
"           1 No. of sub-reaches"
"           Peak outflow                0.437   c.m/sec"
"           0.114      0.437      0.437      0.000 c.m/sec"
" 40           HYDROGRAPH Next link "
"           5 Next link "
"           0.114      0.437      0.437      0.000"
" 52           CHANNEL DESIGN"
"           0.437 Current peak flow      c.m/sec"
"           0.035 Manning 'n'"
"           0. Cross-section type: 0=trapezoidal; 1=general"
"           2.000 Basewidth      metre"
"           2.950 Left bank slope"
"           3.000 Right bank slope"
"           0.950 Channel depth      metre"
"           1.040 Gradient      %"
"           Depth of flow                0.198   metre"
"           Velocity                    0.852   m/sec"
"           Channel capacity              9.246   c.m/sec"
"           Critical depth                0.156   metre"
" 53           ROUTE Channel Route 40"
"           39.80 Channel Route 40 Reach length (metre)"
"           0.366 X-factor <= 0.5"
"           35.033 K-lag (seconds)"
"           0.000 Default(0) or user spec.(1) values used"
"           0.500 X-factor <= 0.5"
"           30.000 K-lag (seconds)"
"           0.500 Beta weighting factor"
"           42.857 Routing time step (seconds)"
"           1 No. of sub-reaches"

```



```

"          Post__25yr
"          Peak outflow          0.437          c.m/sec"
"          0.114          0.437          0.437          0.000 c.m/sec"
40  HYDROGRAPH Combine 100"
"    6  Combine "
"    100 Node #"
"          Existing wetland"
"          Maximum flow          0.437          c.m/sec"
"          Hydrograph volume          5749.782          c.m"
"          0.114          0.437          0.437          0.437"
40  HYDROGRAPH Start - New Tributary"
"    2  Start - New Tributary"
"          0.114          0.000          0.437          0.437"
33  CATCHMENT 2100"
"    1  Triangular SCS"
"    1  Equal length"
"    1  SCS method"
"    2100 Catchment 2100"
"    60.000 % Impervious"
"    1.960 Total Area"
"    40.000 Flow length"
"    2.000 Overland Slope"
"    0.784 Pervious Area"
"    40.000 Pervious length"
"    2.000 Pervious slope"
"    1.176 Impervious Area"
"    40.000 Impervious length"
"    2.000 Impervious slope"
"    0.250 Pervious Manning 'n'"
"    78.000 Pervious SCS Curve No."
"    0.442 Pervious Runoff coefficient"
"    0.100 Pervious Ia/S coefficient"
"    7.164 Pervious Initial abstraction"
"    0.015 Impervious Manning 'n'"
"    98.000 Impervious SCS Curve No."
"    0.913 Impervious Runoff coefficient"
"    0.100 Impervious Ia/S coefficient"
"    0.518 Impervious Initial abstraction"
"          0.435          0.000          0.437          0.437 c.m/sec"
"          Catchment 2100 Pervious Impervious Total Area "
"          Surface Area          0.784          1.176          1.960          hectare"
"          Time of concentration          17.510          2.308          6.016          minutes"
"          Time to Centroid          114.842          87.059          93.835          minutes"
"          Rainfall depth          75.581          75.581          75.581          mm"
"          Rainfall volume          592.55          888.83          1481.38          c.m"
"          Rainfall losses          42.200          6.593          20.835          mm"
"          Runoff depth          33.381          68.988          54.745          mm"
"          Runoff volume          261.71          811.30          1073.01          c.m"
"          Runoff coefficient          0.442          0.913          0.724          "
"          Maximum flow          0.090          0.402          0.435          c.m/sec"
40  HYDROGRAPH Add Runoff "
"    4  Add Runoff "
"          0.435          0.435          0.437          0.437"
33  CATCHMENT 2400"
"    1  Triangular SCS"
"    1  Equal length"
"    1  SCS method"
"    2400 Catchment 2400"
"    90.000 % Impervious"
"    0.790 Total Area"
"    20.000 Flow length"
"    2.000 Overland Slope"
"    0.079 Pervious Area"
"    20.000 Pervious length"

```

```

"      2.000 Pervious slope"
"      0.711 Impervious Area"
"     20.000 Impervious length"
"      2.000 Impervious slope"
"      0.250 Pervious Manning 'n'"
"     78.000 Pervious SCS Curve No."
"      0.441 Pervious Runoff coefficient"
"      0.100 Pervious Ia/S coefficient"
"      7.164 Pervious Initial abstraction"
"      0.015 Impervious Manning 'n'"
"     98.000 Impervious SCS Curve No."
"      0.916 Impervious Runoff coefficient"
"      0.100 Impervious Ia/S coefficient"
"      0.518 Impervious Initial abstraction"
"          0.242      0.435      0.437      0.437 c.m/sec"
"      Catchment 2400 Pervious Impervious Total Area "
"      Surface Area      0.079      0.711      0.790 hectare"
"      Time of concentration 11.553      1.523      2.032 minutes"
"      Time to Centroid 108.042      85.984      87.103 minutes"
"      Rainfall depth 75.581      75.581      75.581 mm"
"      Rainfall volume 59.71      537.38      597.09 c.m"
"      Rainfall losses 42.253      6.330      9.923 mm"
"      Runoff depth 33.328      69.250      65.658 mm"
"      Runoff volume 26.33      492.37      518.70 c.m"
"      Runoff coefficient 0.441      0.916      0.869 "
"      Maximum flow 0.011      0.240      0.242 c.m/sec"
40 HYDROGRAPH Add Runoff "
"      4 Add Runoff "
"          0.242      0.677      0.437      0.437"
54 POND DESIGN"
"      0.677 Current peak flow c.m/sec"
"      0.020 Target outflow c.m/sec"
"     1591.7 Hydrograph volume c.m"
"      13. Number of stages"
"     410.650 Minimum water level metre"
"     411.950 Maximum water level metre"
"     410.650 Starting water level metre"
"      0 Keep Design Data: 1 = True; 0 = False"
"          Level Discharge Volume"
"     410.650 0.000 0.000"
"     410.700 0.00600 42.000"
"     410.800 0.01300 130.000"
"     410.900 0.02000 225.000"
"     411.000 0.02500 328.000"
"     411.100 0.02900 439.000"
"     411.200 0.1260 558.000"
"     411.300 0.1390 686.000"
"     411.400 0.1510 822.000"
"     411.500 0.1630 967.000"
"     411.600 0.1730 1121.000"
"     411.650 0.1780 1202.000"
"     411.950 2.575 1742.000"
"      Peak outflow 0.158 c.m/sec"
"      Maximum level 411.461 metre"
"      Maximum storage 910.360 c.m"
"      Centroidal lag 3.533 hours"
"          0.242      0.677      0.158      0.437 c.m/sec"
40 HYDROGRAPH Next link "
"      5 Next link "
"          0.242      0.158      0.158      0.437"
33 CATCHMENT 2300"
"      1 Triangular SCS"
"      1 Equal length"

```

```

"      1 SCS method"
"      2300 Catchment 2300"
"     10.000 % Impervious"
"      0.480 Total Area"
"     20.000 Flow length"
"      2.000 Overland Slope"
"      0.432 Pervious Area"
"     20.000 Pervious length"
"      2.000 Pervious slope"
"      0.048 Impervious Area"
"     20.000 Impervious length"
"      2.000 Impervious slope"
"      0.250 Pervious Manning 'n'"
"     78.000 Pervious SCS Curve No."
"      0.441 Pervious Runoff coefficient"
"      0.100 Pervious Ia/S coefficient"
"      7.164 Pervious Initial abstraction"
"      0.015 Impervious Manning 'n'"
"     98.000 Impervious SCS Curve No."
"      0.916 Impervious Runoff coefficient"
"      0.100 Impervious Ia/S coefficient"
"      0.518 Impervious Initial abstraction"
"          0.067      0.158      0.158      0.437 c.m/sec"
"      Catchment 2300      Pervious      Impervious      Total Area "
"      Surface Area      0.432      0.048      0.480      hectare"
"      Time of concentration      11.553      1.523      9.671      minutes"
"      Time to Centroid      108.042      85.984      103.905      minutes"
"      Rainfall depth      75.581      75.581      75.581      mm"
"      Rainfall volume      326.51      36.28      362.79      c.m"
"      Rainfall losses      42.253      6.330      38.660      mm"
"      Runoff depth      33.328      69.250      36.920      mm"
"      Runoff volume      143.98      33.24      177.22      c.m"
"      Runoff coefficient      0.441      0.916      0.488      "
"      Maximum flow      0.059      0.016      0.067      c.m/sec"
" 40 HYDROGRAPH Add Runoff "
"      4 Add Runoff "
"          0.067      0.212      0.158      0.437"
" 40 HYDROGRAPH Copy to Outflow"
"      8 Copy to Outflow"
"          0.067      0.212      0.212      0.437"
" 40 HYDROGRAPH Combine 200"
"      6 Combine "
"     200 Node #"
"          To Trib. of Grand River"
"      Maximum flow      0.212      c.m/sec"
"      Hydrograph volume      1770.218      c.m"
"          0.067      0.212      0.212      0.212"
" 40 HYDROGRAPH Start - New Tributary"
"      2 Start - New Tributary"
"          0.067      0.000      0.212      0.212"
" 33 CATCHMENT 2200"
"      1 Triangular SCS"
"      1 Equal length"
"      1 SCS method"
"     2200 Catchment 2200"
"     75.000 % Impervious"
"      0.920 Total Area"
"     40.000 Flow length"
"      2.000 Overland Slope"
"      0.230 Pervious Area"
"     40.000 Pervious length"
"      2.000 Pervious slope"
"      0.690 Impervious Area"

```

```

Post__25yr
" 40.000 Impervious length"
" 2.000 Impervious slope"
" 0.250 Pervious Manning 'n'"
" 78.000 Pervious SCS Curve No."
" 0.442 Pervious Runoff coefficient"
" 0.100 Pervious Ia/S coefficient"
" 7.164 Pervious Initial abstraction"
" 0.015 Impervious Manning 'n'"
" 98.000 Impervious SCS Curve No."
" 0.913 Impervious Runoff coefficient"
" 0.100 Impervious Ia/S coefficient"
" 0.518 Impervious Initial abstraction"
" 0.245 0.000 0.212 0.212 c.m/sec"
" Catchment 2200 Pervious Impervious Total Area "
" Surface Area 0.230 0.690 0.920 hectare"
" Time of concentration 17.510 2.308 4.420 minutes"
" Time to Centroid 114.842 87.059 90.917 minutes"
" Rainfall depth 75.581 75.581 75.581 mm"
" Rainfall volume 173.84 521.51 695.34 c.m"
" Rainfall losses 42.200 6.593 15.494 mm"
" Runoff depth 33.381 68.988 60.086 mm"
" Runoff volume 76.78 476.02 552.80 c.m"
" Runoff coefficient 0.442 0.913 0.795 "
" Maximum flow 0.026 0.236 0.245 c.m/sec"
40 HYDROGRAPH Add Runoff "
4 Add Runoff "
" 0.245 0.245 0.212 0.212"
54 POND DESIGN"
" 0.245 Current peak flow c.m/sec"
" 0.756 Target outflow c.m/sec"
" 552.8 Hydrograph volume c.m"
" 12. Number of stages"
" 413.700 Minimum water level metre"
" 415.000 Maximum water level metre"
" 413.700 Starting water level metre"
" 0 Keep Design Data: 1 = True; 0 = False"
" Level Discharge volume"
" 413.700 0.000 0.000"
" 413.800 0.00500 88.600"
" 413.900 0.01000 187.200"
" 414.000 0.01300 298.400"
" 414.100 0.01500 422.200"
" 414.200 0.2220 558.900"
" 414.300 0.2590 708.500"
" 414.400 0.2910 871.100"
" 414.500 0.3210 1046.900"
" 414.600 0.3470 1236.100"
" 414.700 0.3720 1438.700"
" 415.000 2.808 2087.400"
" Peak outflow 0.026 c.m/sec"
" Maximum level 414.105 metre"
" Maximum storage 429.582 c.m"
" Centroidal lag 7.443 hours"
" 0.245 0.245 0.026 0.212 c.m/sec"
40 HYDROGRAPH Combine 200"
6 Combine "
200 Node #"
" To Trib. of Grand River"
" Maximum flow 0.225 c.m/sec"
" Hydrograph volume 2322.927 c.m"
" 0.245 0.245 0.026 0.225"
40 HYDROGRAPH Start - New Tributary"
2 Start - New Tributary"

```

```

"          0.245      0.000      Post__25yr      0.026      0.225"
" 33      CATCHMENT 3200"
"          1      Triangular SCS"
"          1      Equal length"
"          1      SCS method"
"          3200      Catchment 3200"
"          60.000      % Impervious"
"          0.530      Total Area"
"          40.000      Flow length"
"          1.000      Overland Slope"
"          0.212      Pervious Area"
"          40.000      Pervious length"
"          1.000      Pervious slope"
"          0.318      Impervious Area"
"          40.000      Impervious length"
"          1.000      Impervious slope"
"          0.250      Pervious Manning 'n'"
"          78.000      Pervious SCS Curve No."
"          0.442      Pervious Runoff coefficient"
"          0.100      Pervious Ia/S coefficient"
"          7.164      Pervious Initial abstraction"
"          0.015      Impervious Manning 'n'"
"          98.000      Impervious SCS Curve No."
"          0.908      Impervious Runoff coefficient"
"          0.100      Impervious Ia/S coefficient"
"          0.518      Impervious Initial abstraction"
"          0.115      0.000      0.026      0.225 c.m/sec"
"          Catchment 3200      Pervious      Impervious      Total Area      "
"          Surface Area      0.212      0.318      0.530      hectare"
"          Time of concentration      21.558      2.842      7.426      minutes"
"          Time to Centroid      119.480      87.822      95.576      minutes"
"          Rainfall depth      75.581      75.581      75.581      mm"
"          Rainfall volume      160.23      240.35      400.58      c.m"
"          Rainfall losses      42.201      6.986      21.072      mm"
"          Runoff depth      33.380      68.594      54.509      mm"
"          Runoff volume      70.77      218.13      288.90      c.m"
"          Runoff coefficient      0.442      0.908      0.721      "
"          Maximum flow      0.022      0.108      0.115      c.m/sec"
" 40      HYDROGRAPH Add Runoff "
"          4      Add Runoff "
"          0.115      0.115      0.026      0.225"
" 33      CATCHMENT 3300"
"          1      Triangular SCS"
"          1      Equal length"
"          1      SCS method"
"          3300      Catchment 3300"
"          60.000      % Impervious"
"          0.240      Total Area"
"          20.000      Flow length"
"          2.000      Overland Slope"
"          0.096      Pervious Area"
"          20.000      Pervious length"
"          2.000      Pervious slope"
"          0.144      Impervious Area"
"          20.000      Impervious length"
"          2.000      Impervious slope"
"          0.250      Pervious Manning 'n'"
"          78.000      Pervious SCS Curve No."
"          0.441      Pervious Runoff coefficient"
"          0.100      Pervious Ia/S coefficient"
"          7.164      Pervious Initial abstraction"
"          0.015      Impervious Manning 'n'"
"          98.000      Impervious SCS Curve No."

```



```

"                               Post__25yr
"       7  Confluence "
"       200 Node #"
"           To Trib. of Grand River"
"           Maximum flow           0.648   c.m/sec"
"           Hydrograph volume      8493.319 c.m"
"           0.055   0.648   0.458   0.000"
" 38  START/RE-START TOTALS 200"
"       3  Runoff Totals on EXIT"
"           Total Catchment area           22.640   hectare"
"           Total Impervious area          7.856   hectare"
"           Total % impervious            34.700"
" 19  EXIT"

```

```

"                                     Post__50yr
"
"      MIDUSS Output ----->"
"      MIDUSS version                      Version 2.25 rev. 473"
"      MIDUSS created                      Sunday, February 07, 2010"
"      10  Units used:                      ie METRIC"
"      Job folder:                         w:\Kitchener\411-2011\411009\Design Data\
"                                          Modelling Files\2019-02-15"
"
"      Output filename:                    Post__50yr.out"
"      Licensee name:                      gmbp"
"      Company                             Hewlett-Packard Company"
"      Date & Time last used:             2/15/2019 at 3:57:45 PM"
" 31  TIME PARAMETERS"
"      5.000  Time Step"
"      180.000 Max. Storm length"
"      12000.000 Max. Hydrograph"
" 32  STORM Chicago storm"
"      1  Chicago storm"
"      5089.418 Coefficient A"
"      30.000  Constant B"
"      0.967  Exponent C"
"      0.380  Fraction R"
"      180.000 Duration"
"      1.000  Time step multiplier"
"      Maximum intensity          156.350  mm/hr"
"      Total depth                86.737  mm"
"      6  050hyd  Hydrograph extension used in this file"
" 33  CATCHMENT 1200"
"      1  Triangular SCS"
"      1  Equal length"
"      1  SCS method"
"      1200  Catchment 1200"
"      50.000 % Impervious"
"      0.220  Total Area"
"      10.000 Flow length"
"      2.000  Overland slope"
"      0.110  Pervious Area"
"      10.000 Pervious length"
"      2.000  Pervious slope"
"      0.110  Impervious Area"
"      10.000 Impervious length"
"      2.000  Impervious slope"
"      0.250  Pervious Manning 'n'"
"      78.000 Pervious SCS Curve No."
"      0.479  Pervious Runoff coefficient"
"      0.100  Pervious Ia/S coefficient"
"      7.164  Pervious Initial abstraction"
"      0.015  Impervious Manning 'n'"
"      98.000 Impervious SCS Curve No."
"      0.904  Impervious Runoff coefficient"
"      0.100  Impervious Ia/S coefficient"
"      0.518  Impervious Initial abstraction"
"      0.055  0.000  0.000  0.000 c.m/sec"
"      Catchment 1200  Pervious  Impervious  Total Area  "
"      Surface Area    0.110    0.110    0.220    hectare"
"      Time of concentration  7.056    0.968    3.076    minutes"
"      Time to Centroid    102.283    85.178    91.100    minutes"
"      Rainfall depth     86.737    86.737    86.737    mm"
"      Rainfall volume    95.41    95.41    190.82    c.m"
"      Rainfall losses    45.201    8.296    26.748    mm"
"      Runoff depth       41.536    78.441    59.988    mm"
"      Runoff volume      45.69    86.28    131.97    c.m"
"      Runoff coefficient  0.479    0.904    0.692    "
"      Maximum flow      0.021    0.041    0.055    c.m/sec"
" 40  HYDROGRAPH Add Runoff "

```



```

"                                     Post__50yr
"         4  Add Runoff "
"           0.055      0.055      0.000      0.000"
" 33      CATCHMENT 1300"
"         1  Triangular SCS"
"         1  Equal length"
"         1  SCS method"
"        1300  Catchment 1300"
"       50.000  % Impervious"
"         0.840  Total Area"
"       20.000  Flow length"
"         2.000  Overland Slope"
"         0.420  Pervious Area"
"       20.000  Pervious length"
"         2.000  Pervious slope"
"         0.420  Impervious Area"
"       20.000  Impervious length"
"         2.000  Impervious slope"
"         0.250  Pervious Manning 'n'"
"       78.000  Pervious SCS Curve No."
"         0.481  Pervious Runoff coefficient"
"         0.100  Pervious Ia/S coefficient"
"         7.164  Pervious Initial abstraction"
"         0.015  Impervious Manning 'n'"
"       98.000  Impervious SCS Curve No."
"         0.924  Impervious Runoff coefficient"
"         0.100  Impervious Ia/S coefficient"
"         0.518  Impervious Initial abstraction"
"           0.203      0.055      0.000      0.000 c.m/sec"
"       Catchment 1300      Pervious      Impervious      Total Area "
"       Surface Area      0.420      0.420      0.840      hectare"
"       Time of concentration      10.695      1.467      4.627      minutes"
"       Time to Centroid      106.283      85.675      92.731      minutes"
"       Rainfall depth      86.737      86.737      86.737      mm"
"       Rainfall volume      364.29      364.29      728.59      c.m"
"       Rainfall losses      44.994      6.561      25.777      mm"
"       Runoff depth      41.743      80.176      60.959      mm"
"       Runoff volume      175.32      336.74      512.06      c.m"
"       Runoff coefficient      0.481      0.924      0.703      "
"       Maximum flow      0.072      0.158      0.203      c.m/sec"
" 40      HYDROGRAPH Add Runoff "
"         4  Add Runoff "
"           0.203      0.258      0.000      0.000"
" 33      CATCHMENT 1600"
"         1  Triangular SCS"
"         1  Equal length"
"         1  SCS method"
"        1600  Catchment 1600"
"       50.000  % Impervious"
"         0.360  Total Area"
"       15.000  Flow length"
"         2.000  Overland Slope"
"         0.180  Pervious Area"
"       15.000  Pervious length"
"         2.000  Pervious slope"
"         0.180  Impervious Area"
"       15.000  Impervious length"
"         2.000  Impervious slope"
"         0.250  Pervious Manning 'n'"
"       78.000  Pervious SCS Curve No."
"         0.480  Pervious Runoff coefficient"
"         0.100  Pervious Ia/S coefficient"
"         7.164  Pervious Initial abstraction"
"         0.015  Impervious Manning 'n'"

```

```

Post__50yr
" 98.000 Impervious SCS Curve No."
" 0.919 Impervious Runoff coefficient"
" 0.100 Impervious Ia/S coefficient"
" 0.518 Impervious Initial abstraction"
" 0.089 0.258 0.000 0.000 c.m/sec"
" Catchment 1600 Pervious Impervious Total Area "
" Surface Area 0.180 0.180 0.360 hectare"
" Time of concentration 9.000 1.235 3.900 minutes"
" Time to Centroid 104.357 85.382 91.895 minutes"
" Rainfall depth 86.737 86.737 86.737 mm"
" Rainfall volume 156.13 156.13 312.25 c.m"
" Rainfall losses 45.077 7.038 26.057 mm"
" Runoff depth 41.660 79.699 60.679 mm"
" Runoff volume 74.99 143.46 218.45 c.m"
" Runoff coefficient 0.480 0.919 0.700 "
" Maximum flow 0.033 0.068 0.089 c.m/sec"
40 HYDROGRAPH Add Runoff "
" 4 Add Runoff "
" 0.089 0.347 0.000 0.000"
54 POND DESIGN"
" 0.347 Current peak flow c.m/sec"
" 0.250 Target outflow c.m/sec"
" 862.5 Hydrograph volume c.m"
" 16. Number of stages"
" 411.830 Minimum water level metre"
" 414.490 Maximum water level metre"
" 411.830 Starting water level metre"
" 0 Keep Design Data: 1 = True; 0 = False"
" Level Discharge Volume"
" 411.830 0.00033 0.000"
" 411.930 0.00033 19.920"
" 412.230 0.00034 143.570"
" 412.530 0.00035 267.220"
" 412.630 0.00035 287.130"
" 412.700 0.00035 301.070"
" 412.800 0.00035 301.140"
" 413.000 0.00035 301.260"
" 413.230 0.00035 301.400"
" 413.430 0.04510 301.740"
" 413.630 0.1310 302.400"
" 413.830 0.2461 303.400"
" 414.030 0.3862 304.740"
" 414.090 0.4327 305.240"
" 414.290 0.6461 307.240"
" 414.490 0.9189 309.570"
" Peak outflow 0.313 c.m/sec"
" Maximum level 413.950 metre"
" Maximum storage 304.205 c.m"
" Centroidal lag 32.242 hours"
" 0.089 0.347 0.313 0.000 c.m/sec"
40 HYDROGRAPH Combine 1"
" 6 Combine "
" 1 Node #"
" Outlets to SWMF No. 1"
" Maximum flow 0.313 c.m/sec"
" Hydrograph volume 789.084 c.m"
" 0.089 0.347 0.313 0.313"
40 HYDROGRAPH Start - New Tributary"
" 2 Start - New Tributary"
" 0.089 0.000 0.313 0.313"
33 CATCHMENT 1400"
" 1 Triangular SCS"
" 1 Equal length"

```

Post__50yr

```

"      1  SCS method"
"      1400 Catchment 1400"
"      20.000 % Impervious"
"      0.620 Total Area"
"      30.000 Flow length"
"      2.000 Overland Slope"
"      0.496 Pervious Area"
"      30.000 Pervious length"
"      2.000 Pervious slope"
"      0.124 Impervious Area"
"      30.000 Impervious length"
"      2.000 Impervious slope"
"      0.250 Pervious Manning 'n'"
"      78.000 Pervious SCS Curve No."
"      0.482 Pervious Runoff coefficient"
"      0.100 Pervious Ia/S coefficient"
"      7.164 Pervious Initial abstraction"
"      0.015 Impervious Manning 'n'"
"      98.000 Impervious SCS Curve No."
"      0.925 Impervious Runoff coefficient"
"      0.100 Impervious Ia/S coefficient"
"      0.518 Impervious Initial abstraction"
"      0.105      0.000      0.313      0.313 c.m/sec"
"      Catchment 1400      Pervious      Impervious      Total Area "
"      Surface Area      0.496      0.124      0.620      hectare"
"      Time of concentration      13.641      1.872      9.825      minutes"
"      Time to Centroid      109.632      86.148      102.018      minutes"
"      Rainfall depth      86.737      86.737      86.737      mm"
"      Rainfall volume      430.21      107.55      537.77      c.m"
"      Rainfall losses      44.941      6.526      37.258      mm"
"      Runoff depth      41.796      80.211      49.479      mm"
"      Runoff volume      207.31      99.46      306.77      c.m"
"      Runoff coefficient      0.482      0.925      0.570      "
"      Maximum flow      0.079      0.047      0.105      c.m/sec"
" 40      HYDROGRAPH Add Runoff "
"      4      Add Runoff "
"      0.105      0.105      0.313      0.313"
" 54      POND DESIGN"
"      0.105      Current peak flow      c.m/sec"
"      0.250      Target outflow      c.m/sec"
"      306.8      Hydrograph volume      c.m"
"      17.      Number of stages"
"      413.920      Minimum water level      metre"
"      415.520      Maximum water level      metre"
"      413.920      Starting water level      metre"
"      0      Keep Design Data: 1 = True; 0 = False"
"      Level Discharge      Volume"
"      413.920      0.00089      0.000"
"      414.020      0.00089      26.670"
"      414.120      0.00090      54.610"
"      414.220      0.00090      82.540"
"      414.320      0.00090      110.480"
"      414.420      0.00091      138.420"
"      414.520      0.00091      165.090"
"      414.620      0.00091      191.760"
"      414.720      0.00091      191.830"
"      414.820      0.02640      191.900"
"      414.920      0.03734      191.970"
"      415.020      0.04573      192.040"
"      415.120      0.05281      192.120"
"      415.220      0.2777      201.400"
"      415.320      0.6941      238.900"
"      415.420      1.244      304.650"

```

			Post_50yr		
"	415.520	1.909	382.150"		
"	Peak outflow		0.046	c.m/sec"	
"	Maximum level		415.121	metre"	
"	Maximum storage		192.241	c.m"	
"	Centroidal lag		22.249	hours"	
"	0.105	0.105	0.046	0.313	c.m/sec"
40	HYDROGRAPH Next link "				
"	5 Next link "				
"	0.105	0.046	0.046	0.313"	
33	CATCHMENT 1500"				
"	1 Triangular SCS"				
"	1 Equal length"				
"	1 SCS method"				
"	1500 Catchment 1500"				
"	50.000 % Impervious"				
"	1.110 Total Area"				
"	40.000 Flow length"				
"	2.000 Overland Slope"				
"	0.555 Pervious Area"				
"	40.000 Pervious length"				
"	2.000 Pervious slope"				
"	0.555 Impervious Area"				
"	40.000 Impervious length"				
"	2.000 Impervious slope"				
"	0.250 Pervious Manning 'n'"				
"	78.000 Pervious SCS Curve No."				
"	0.481 Pervious Runoff coefficient"				
"	0.100 Pervious Ia/S coefficient"				
"	7.164 Pervious Initial abstraction"				
"	0.015 Impervious Manning 'n'"				
"	98.000 Impervious SCS Curve No."				
"	0.922 Impervious Runoff coefficient"				
"	0.100 Impervious Ia/S coefficient"				
"	0.518 Impervious Initial abstraction"				
"	0.242	0.046	0.046	0.313	c.m/sec"
"	Catchment 1500	Pervious	Impervious	Total Area	"
"	Surface Area	0.555	0.555	1.110	hectare"
"	Time of concentration	16.211	2.224	7.023	minutes"
"	Time to Centroid	112.570	86.667	95.554	minutes"
"	Rainfall depth	86.737	86.737	86.737	mm"
"	Rainfall volume	481.39	481.39	962.78	c.m"
"	Rainfall losses	44.974	6.774	25.874	mm"
"	Runoff depth	41.763	79.963	60.863	mm"
"	Runoff volume	231.78	443.80	675.58	c.m"
"	Runoff coefficient	0.481	0.922	0.702	"
"	Maximum flow	0.084	0.210	0.242	c.m/sec"
40	HYDROGRAPH Add Runoff "				
"	4 Add Runoff "				
"	0.242	0.243	0.046	0.313"	
56	DIVERSION"				
"	1500 Node number"				
"	0.146 Overflow threshold"				
"	1.000 Required diverted fraction"				
"	0 Conduit type; 1=Pipe;2=Channel"				
"	Peak of diverted flow		0.097	c.m/sec"	
"	Volume of diverted flow		92.143	c.m"	
"	DIV01500.050hyd"				
"	Major flow at 1500"				
"	0.242	0.243	0.146	0.313	c.m/sec"
40	HYDROGRAPH Next link "				
"	5 Next link "				
"	0.242	0.146	0.146	0.313"	
33	CATCHMENT 1000"				

```

"      1 Triangular SCS"
"      1 Equal length"
"      1 SCS method"
"    1000 Catchment 1000"
"    50.000 % Impervious"
"     6.760 Total Area"
"   100.000 Flow length"
"     2.000 Overland Slope"
"     3.380 Pervious Area"
"   100.000 Pervious length"
"     2.000 Pervious slope"
"     3.380 Impervious Area"
"   100.000 Impervious length"
"     2.000 Impervious slope"
"     0.250 Pervious Manning 'n'"
"    78.000 Pervious SCS Curve No."
"     0.482 Pervious Runoff coefficient"
"     0.100 Pervious Ia/S coefficient"
"     7.164 Pervious Initial abstraction"
"     0.015 Impervious Manning 'n'"
"   98.000 Impervious SCS Curve No."
"     0.923 Impervious Runoff coefficient"
"     0.100 Impervious Ia/S coefficient"
"     0.518 Impervious Initial abstraction"
"           1.406      0.146      0.146      0.313 c.m/sec"
"   Catchment 1000      Pervious      Impervious      Total Area      "
"   Surface Area      3.380      3.380      6.760      hectare"
"   Time of concentration      28.092      3.854      12.172      minutes"
"   Time to Centroid      125.992      88.892      101.624      minutes"
"   Rainfall depth      86.737      86.737      86.737      mm"
"   Rainfall volume      2931.70      2931.70      5863.41      c.m"
"   Rainfall losses      44.916      6.695      25.806      mm"
"   Runoff depth      41.821      80.042      60.931      mm"
"   Runoff volume      1413.54      2705.42      4118.95      c.m"
"   Runoff coefficient      0.482      0.923      0.702      "
"   Maximum flow      0.381      1.324      1.406      c.m/sec"
" 40 HYDROGRAPH Add Runoff "
"     4 Add Runoff "
"           1.406      1.552      0.146      0.313"
" 33 CATCHMENT 1100"
"     1 Triangular SCS"
"     1 Equal length"
"     1 SCS method"
"    1100 Catchment 1100"
"     0.000 % Impervious"
"     0.480 Total Area"
"    20.000 Flow length"
"     2.000 Overland Slope"
"     0.480 Pervious Area"
"    20.000 Pervious length"
"     2.000 Pervious slope"
"     0.000 Impervious Area"
"    20.000 Impervious length"
"     2.000 Impervious slope"
"     0.250 Pervious Manning 'n'"
"    78.000 Pervious SCS Curve No."
"     0.481 Pervious Runoff coefficient"
"     0.100 Pervious Ia/S coefficient"
"     7.164 Pervious Initial abstraction"
"     0.015 Impervious Manning 'n'"
"   98.000 Impervious SCS Curve No."
"     0.000 Impervious Runoff coefficient"
"     0.100 Impervious Ia/S coefficient"

```

```

"           Post__50yr
" 0.518  Impervious Initial abstraction"
"           0.082      1.552      0.146      0.313 c.m/sec"
"           Catchment 1100 Pervious Impervious Total Area "
"           Surface Area      0.480      0.000      0.480      hectare"
"           Time of concentration 10.695      1.467      10.695      minutes"
"           Time to Centroid      106.283      85.675      106.283      minutes"
"           Rainfall depth      86.737      86.737      86.737      mm"
"           Rainfall volume      416.34      0.00      416.34      c.m"
"           Rainfall losses      44.994      6.561      44.994      mm"
"           Runoff depth      41.743      80.176      41.743      mm"
"           Runoff volume      200.37      0.00      200.37      c.m"
"           Runoff coefficient      0.481      0.000      0.481      "
"           Maximum flow      0.082      0.000      0.082      c.m/sec"
" 40 HYDROGRAPH Add Runoff "
" 4  Add Runoff "
"           0.082      1.608      0.146      0.313"
" 40 HYDROGRAPH Copy to Outflow"
" 8  Copy to Outflow"
"           0.082      1.608      1.608      0.313"
" 40 HYDROGRAPH Combine 1"
" 6  Combine "
" 1  Node #"
"           Outlets to SWMF No. 1"
"           Maximum flow      1.652      c.m/sec"
"           Hydrograph volume      5996.520      c.m"
"           0.082      1.608      1.608      1.652"
" 40 HYDROGRAPH Confluence 1"
" 7  Confluence "
" 1  Node #"
"           Outlets to SWMF No. 1"
"           Maximum flow      1.652      c.m/sec"
"           Hydrograph volume      5996.521      c.m"
"           0.082      1.652      1.608      0.000"
" 54 POND DESIGN"
" 1.652  Current peak flow      c.m/sec"
" 0.250  Target outflow      c.m/sec"
" 5996.5  Hydrograph volume      c.m"
" 11.    Number of stages"
" 411.000  Minimum water level      metre"
" 412.000  Maximum water level      metre"
" 411.000  Starting water level      metre"
" 0  Keep Design Data: 1 = True; 0 = False"
"           Level Discharge      volume"
" 411.000      0.000      0.000"
" 411.100      0.05100      425.000"
" 411.200      0.1030      936.000"
" 411.300      0.1190      1459.000"
" 411.400      0.1330      1994.000"
" 411.500      0.3220      2542.000"
" 411.600      0.3510      3101.000"
" 411.700      0.3780      3673.000"
" 411.800      0.4030      4258.000"
" 411.850      0.4150      4554.000"
" 412.000      2.088      5464.000"
"           Peak outflow      0.368      c.m/sec"
"           Maximum level      411.663      metre"
"           Maximum storage      3461.072      c.m"
"           Centroidal lag      9.347      hours"
"           0.082      1.652      0.368      0.000 c.m/sec"
" 40 HYDROGRAPH Next link "
" 5  Next link "
"           0.082      0.368      0.368      0.000"
" 47 FILEI_0 Read/Open DIV01500.050hyd"

```

```

Post__50yr
" 1 1=read/open; 2=write/save"
" 2 1=rainfall; 2=hydrograph"
" 1 1=runoff; 2=inflow; 3=outflow; 4=junction"
" DIV01500.050hyd"
" Major flow at 1500"
" Total volume 92.143 c.m"
" Maximum flow 0.097 c.m/sec"
" 0.097 0.368 0.368 0.000 c.m/sec"
40 HYDROGRAPH Add Runoff "
" 4 Add Runoff "
" 0.097 0.368 0.368 0.000"
33 CATCHMENT 4000"
" 1 Triangular SCS"
" 1 Equal length"
" 1 SCS method"
" 4000 Catchment 4000"
" 0.000 % Impervious"
" 7.330 Total Area"
" 60.000 Flow length"
" 2.000 Overland Slope"
" 7.330 Pervious Area"
" 60.000 Pervious length"
" 2.000 Pervious slope"
" 0.000 Impervious Area"
" 60.000 Impervious length"
" 2.000 Impervious slope"
" 0.250 Pervious Manning 'n'"
" 50.000 Pervious SCS Curve No."
" 0.137 Pervious Runoff coefficient"
" 0.100 Pervious Ia/S coefficient"
" 25.400 Pervious Initial abstraction"
" 0.015 Impervious Manning 'n'"
" 98.000 Impervious SCS Curve No."
" 0.000 Impervious Runoff coefficient"
" 0.100 Impervious Ia/S coefficient"
" 0.518 Impervious Initial abstraction"
" 0.183 0.368 0.368 0.000 c.m/sec"
" Catchment 4000 Pervious Impervious Total Area "
" Surface Area 7.330 0.000 7.330 hectare"
" Time of concentration 37.472 2.837 37.472 minutes"
" Time to Centroid 142.983 87.552 142.982 minutes"
" Rainfall depth 86.737 86.737 86.737 mm"
" Rainfall volume 6357.80 0.01 6357.80 c.m"
" Rainfall losses 74.812 7.307 74.812 mm"
" Runoff depth 11.925 79.429 11.925 mm"
" Runoff volume 874.09 0.01 874.10 c.m"
" Runoff coefficient 0.137 0.000 0.137 "
" Maximum flow 0.183 0.000 0.183 c.m/sec"
40 HYDROGRAPH Add Runoff "
" 4 Add Runoff "
" 0.183 0.543 0.368 0.000"
54 POND DESIGN"
" 0.543 Current peak flow c.m/sec"
" 0.250 Target outflow c.m/sec"
" 6957.4 Hydrograph volume c.m"
" 6. Number of stages"
" 409.630 Minimum water level metre"
" 410.750 Maximum water level metre"
" 409.630 Starting water level metre"
" 0 Keep Design Data: 1 = True; 0 = False"
" Level Discharge Volume"
" 409.630 0.000 0.000"
" 409.750 0.6650 402.200"

```

```

"                               Post__50yr
"           410.000      3.601  2187.900"
"           410.250      7.811  5318.900"
"           410.500     12.984  9642.300"
"           410.750     18.965 15227.70"
"           Peak outflow                0.525   c.m/sec"
"           Maximum level                409.725  metre"
"           Maximum storage              317.508   c.m"
"           Centroidal lag               8.528    hours"
"           0.183      0.543      0.525      0.000 c.m/sec"
" 40     HYDROGRAPH Next link "
"           5 Next link "
"           0.183      0.525      0.525      0.000"
" 52     CHANNEL DESIGN"
"           0.525 Current peak flow      c.m/sec"
"           0.035 Manning 'n'"
"           0. Cross-section type: 0=trapezoidal; 1=general"
"           0.000 Basewidth      metre"
"           7.410 Left bank slope"
"           6.000 Right bank slope"
"           0.950 Channel depth      metre"
"           1.040 Gradient      %"
"           Depth of flow                0.307   metre"
"           Velocity                    0.830   m/sec"
"           Channel capacity              10.655  c.m/sec"
"           Critical depth                0.263   metre"
" 53     ROUTE Channel Route 72"
"           72.40 Channel Route 72 Reach length (metre)"
"           0.423 X-factor <= 0.5"
"           65.457 K-lag (seconds)"
"           0.000 Default(0) or user spec.(1) values used"
"           0.500 X-factor <= 0.5"
"           30.000 K-lag (seconds)"
"           0.500 Beta weighting factor"
"           75.000 Routing time step (seconds)"
"           1 No. of sub-reaches"
"           Peak outflow                0.524   c.m/sec"
"           0.183      0.525      0.524      0.000 c.m/sec"
" 40     HYDROGRAPH Next link "
"           5 Next link "
"           0.183      0.524      0.524      0.000"
" 52     CHANNEL DESIGN"
"           0.524 Current peak flow      c.m/sec"
"           0.035 Manning 'n'"
"           0. Cross-section type: 0=trapezoidal; 1=general"
"           2.000 Basewidth      metre"
"           2.950 Left bank slope"
"           3.000 Right bank slope"
"           0.950 Channel depth      metre"
"           1.040 Gradient      %"
"           Depth of flow                0.219   metre"
"           Velocity                    0.902   m/sec"
"           Channel capacity              9.246   c.m/sec"
"           Critical depth                0.175   metre"
" 53     ROUTE Channel Route 40"
"           39.80 Channel Route 40 Reach length (metre)"
"           0.353 X-factor <= 0.5"
"           33.104 K-lag (seconds)"
"           0.000 Default(0) or user spec.(1) values used"
"           0.500 X-factor <= 0.5"
"           30.000 K-lag (seconds)"
"           0.500 Beta weighting factor"
"           37.500 Routing time step (seconds)"
"           1 No. of sub-reaches"

```

			Post_50yr		
"	Peak outflow		0.524		c.m/sec"
"		0.183	0.524	0.524	0.000 c.m/sec"
" 40	HYDROGRAPH Combine		100"		
"	6 Combine "				
"	100 Node #"				
"	Existing wetland"				
"	Maximum flow		0.524		c.m/sec"
"	Hydrograph volume		6957.213		c.m"
"		0.183	0.524	0.524	0.524"
" 40	HYDROGRAPH Start - New Tributary"				
"	2 Start - New Tributary"				
"		0.183	0.000	0.524	0.524"
" 33	CATCHMENT 2100"				
"	1 Triangular SCS"				
"	1 Equal length"				
"	1 SCS method"				
"	2100 Catchment 2100"				
"	60.000 % Impervious"				
"	1.960 Total Area"				
"	40.000 Flow length"				
"	2.000 Overland Slope"				
"	0.784 Pervious Area"				
"	40.000 Pervious length"				
"	2.000 Pervious slope"				
"	1.176 Impervious Area"				
"	40.000 Impervious length"				
"	2.000 Impervious slope"				
"	0.250 Pervious Manning 'n'"				
"	78.000 Pervious SCS Curve No."				
"	0.481 Pervious Runoff coefficient"				
"	0.100 Pervious Ia/S coefficient"				
"	7.164 Pervious Initial abstraction"				
"	0.015 Impervious Manning 'n'"				
"	98.000 Impervious SCS Curve No."				
"	0.922 Impervious Runoff coefficient"				
"	0.100 Impervious Ia/S coefficient"				
"	0.518 Impervious Initial abstraction"				
"		0.491	0.000	0.524	0.524 c.m/sec"
"	Catchment 2100 Pervious				
"	Surface Area	0.784	1.176	1.960	hectare"
"	Time of concentration	16.211	2.224	5.836	minutes"
"	Time to Centroid	112.570	86.667	93.357	minutes"
"	Rainfall depth	86.737	86.737	86.737	mm"
"	Rainfall volume	680.02	1020.02	1700.04	c.m"
"	Rainfall losses	44.974	6.773	22.054	mm"
"	Runoff depth	41.763	79.963	64.683	mm"
"	Runoff volume	327.42	940.37	1267.79	c.m"
"	Runoff coefficient	0.481	0.922	0.746	"
"	Maximum flow	0.119	0.446	0.491	c.m/sec"
" 40	HYDROGRAPH Add Runoff "				
"	4 Add Runoff "				
"		0.491	0.491	0.524	0.524"
" 33	CATCHMENT 2400"				
"	1 Triangular SCS"				
"	1 Equal length"				
"	1 SCS method"				
"	2400 Catchment 2400"				
"	90.000 % Impervious"				
"	0.790 Total Area"				
"	20.000 Flow length"				
"	2.000 Overland Slope"				
"	0.079 Pervious Area"				
"	20.000 Pervious length"				

```

Post__50yr
"      2.000 Pervious slope"
"      0.711 Impervious Area"
"     20.000 Impervious length"
"      2.000 Impervious slope"
"      0.250 Pervious Manning 'n'"
"     78.000 Pervious SCS Curve No."
"      0.481 Pervious Runoff coefficient"
"      0.100 Pervious Ia/S coefficient"
"      7.164 Pervious Initial abstraction"
"      0.015 Impervious Manning 'n'"
"     98.000 Impervious SCS Curve No."
"      0.924 Impervious Runoff coefficient"
"      0.100 Impervious Ia/S coefficient"
"      0.518 Impervious Initial abstraction"
"          0.270      0.491      0.524      0.524 c.m/sec"
"      Catchment 2400 Pervious Impervious Total Area "
"      Surface Area      0.079      0.711      0.790 hectare"
"      Time of concentration 10.695      1.467      1.972 minutes"
"      Time to Centroid 106.283      85.675      86.802 minutes"
"      Rainfall depth      86.737      86.737      86.737 mm"
"      Rainfall volume      68.52      616.70      685.22 c.m"
"      Rainfall losses      44.994      6.561      10.404 mm"
"      Runoff depth      41.743      80.176      76.332 mm"
"      Runoff volume      32.98      570.05      603.03 c.m"
"      Runoff coefficient      0.481      0.924      0.880 "
"      Maximum flow      0.014      0.267      0.270 c.m/sec"
40 HYDROGRAPH Add Runoff "
"      4 Add Runoff "
"          0.270      0.760      0.524      0.524"
54 POND DESIGN"
"      0.760 Current peak flow c.m/sec"
"      0.020 Target outflow c.m/sec"
"     1870.8 Hydrograph volume c.m"
"      13. Number of stages"
"     410.650 Minimum water level metre"
"     411.950 Maximum water level metre"
"     410.650 Starting water level metre"
"      0 Keep Design Data: 1 = True; 0 = False"
"          Level Discharge Volume"
"     410.650      0.000      0.000"
"     410.700      0.00600      42.000"
"     410.800      0.01300      130.000"
"     410.900      0.02000      225.000"
"     411.000      0.02500      328.000"
"     411.100      0.02900      439.000"
"     411.200      0.1260      558.000"
"     411.300      0.1390      686.000"
"     411.400      0.1510      822.000"
"     411.500      0.1630      967.000"
"     411.600      0.1730      1121.000"
"     411.650      0.1780      1202.000"
"     411.950      2.575      1742.000"
"      Peak outflow      0.171 c.m/sec"
"      Maximum level      411.583 metre"
"      Maximum storage      1094.508 c.m"
"      Centroidal lag      3.522 hours"
"          0.270      0.760      0.171      0.524 c.m/sec"
40 HYDROGRAPH Next link "
"      5 Next link "
"          0.270      0.171      0.171      0.524"
33 CATCHMENT 2300"
"      1 Triangular SCS"
"      1 Equal length"

```

```

"      1 SCS method"
"      2300 Catchment 2300"
"     10.000 % Impervious"
"      0.480 Total Area"
"     20.000 Flow length"
"      2.000 Overland Slope"
"      0.432 Pervious Area"
"     20.000 Pervious length"
"      2.000 Pervious slope"
"      0.048 Impervious Area"
"     20.000 Impervious length"
"      2.000 Impervious slope"
"      0.250 Pervious Manning 'n'"
"     78.000 Pervious SCS Curve No."
"      0.481 Pervious Runoff coefficient"
"      0.100 Pervious Ia/S coefficient"
"      7.164 Pervious Initial abstraction"
"      0.015 Impervious Manning 'n'"
"     98.000 Impervious SCS Curve No."
"      0.924 Impervious Runoff coefficient"
"      0.100 Impervious Ia/S coefficient"
"      0.518 Impervious Initial abstraction"
"          0.086      0.171      0.171      0.524 c.m/sec"
"      Catchment 2300      Pervious      Impervious      Total Area      "
"      Surface Area      0.432      0.048      0.480      hectare"
"      Time of concentration      10.695      1.467      9.072      minutes"
"      Time to Centroid      106.283      85.675      102.658      minutes"
"      Rainfall depth      86.737      86.737      86.737      mm"
"      Rainfall volume      374.70      41.63      416.34      c.m"
"      Rainfall losses      44.994      6.561      41.150      mm"
"      Runoff depth      41.743      80.176      45.586      mm"
"      Runoff volume      180.33      38.48      218.81      c.m"
"      Runoff coefficient      0.481      0.924      0.526      "
"      Maximum flow      0.074      0.018      0.086      c.m/sec"
" 40      HYDROGRAPH Add Runoff "
"      4      Add Runoff "
"          0.086      0.240      0.171      0.524"
" 40      HYDROGRAPH Copy to Outflow"
"      8      Copy to Outflow"
"          0.086      0.240      0.240      0.524"
" 40      HYDROGRAPH Combine 200"
"      6      Combine "
"     200      Node #"
"          To Trib. of Grand River"
"          Maximum flow      0.240      c.m/sec"
"          Hydrograph volume      2090.359      c.m"
"          0.086      0.240      0.240      0.240"
" 40      HYDROGRAPH Start - New Tributary"
"      2      Start - New Tributary"
"          0.086      0.000      0.240      0.240"
" 33      CATCHMENT 2200"
"      1      Triangular SCS"
"      1      Equal length"
"      1      SCS method"
"     2200      Catchment 2200"
"     75.000      % Impervious"
"      0.920      Total Area"
"     40.000      Flow length"
"      2.000      Overland Slope"
"      0.230      Pervious Area"
"     40.000      Pervious length"
"      2.000      Pervious slope"
"      0.690      Impervious Area"

```

```

Post__50yr
" 40.000 Impervious length"
" 2.000 Impervious slope"
" 0.250 Pervious Manning 'n'"
" 78.000 Pervious SCS Curve No."
" 0.481 Pervious Runoff coefficient"
" 0.100 Pervious Ia/S coefficient"
" 7.164 Pervious Initial abstraction"
" 0.015 Impervious Manning 'n'"
" 98.000 Impervious SCS Curve No."
" 0.922 Impervious Runoff coefficient"
" 0.100 Impervious Ia/S coefficient"
" 0.518 Impervious Initial abstraction"
" 0.275 0.000 0.240 0.240 c.m/sec"
" Catchment 2200 Pervious Impervious Total Area "
" Surface Area 0.230 0.690 0.920 hectare"
" Time of concentration 16.211 2.224 4.298 minutes"
" Time to Centroid 112.570 86.667 90.508 minutes"
" Rainfall depth 86.737 86.737 86.737 mm"
" Rainfall volume 199.49 598.48 797.98 c.m"
" Rainfall losses 44.974 6.774 16.324 mm"
" Runoff depth 41.763 79.963 70.413 mm"
" Runoff volume 96.05 551.75 647.80 c.m"
" Runoff coefficient 0.481 0.922 0.812 "
" Maximum flow 0.035 0.262 0.275 c.m/sec"
40 HYDROGRAPH Add Runoff "
4 Add Runoff "
" 0.275 0.275 0.240 0.240"
54 POND DESIGN"
" 0.275 Current peak flow c.m/sec"
" 0.756 Target outflow c.m/sec"
" 647.8 Hydrograph volume c.m"
" 12. Number of stages"
" 413.700 Minimum water level metre"
" 415.000 Maximum water level metre"
" 413.700 Starting water level metre"
" 0 Keep Design Data: 1 = True; 0 = False"
" Level Discharge volume"
" 413.700 0.000 0.000"
" 413.800 0.00500 88.600"
" 413.900 0.01000 187.200"
" 414.000 0.01300 298.400"
" 414.100 0.01500 422.200"
" 414.200 0.2220 558.900"
" 414.300 0.2590 708.500"
" 414.400 0.2910 871.100"
" 414.500 0.3210 1046.900"
" 414.600 0.3470 1236.100"
" 414.700 0.3720 1438.700"
" 415.000 2.808 2087.400"
" Peak outflow 0.058 c.m/sec"
" Maximum level 414.121 metre"
" Maximum storage 450.749 c.m"
" Centroidal lag 6.675 hours"
" 0.275 0.275 0.058 0.240 c.m/sec"
40 HYDROGRAPH Combine 200"
6 Combine "
200 Node #"
" To Trib. of Grand River"
" Maximum flow 0.260 c.m/sec"
" Hydrograph volume 2737.636 c.m"
" 0.275 0.275 0.058 0.260"
40 HYDROGRAPH Start - New Tributary"
2 Start - New Tributary"

```

			Post_50yr		
"		0.275	0.000	0.058	0.260"
" 33		CATCHMENT 3200"			
"	1	Triangular SCS"			
"	1	Equal length"			
"	1	SCS method"			
"	3200	Catchment 3200"			
"	60.000	% Impervious"			
"	0.530	Total Area"			
"	40.000	Flow length"			
"	1.000	Overland Slope"			
"	0.212	Pervious Area"			
"	40.000	Pervious length"			
"	1.000	Pervious slope"			
"	0.318	Impervious Area"			
"	40.000	Impervious length"			
"	1.000	Impervious slope"			
"	0.250	Pervious Manning 'n'"			
"	78.000	Pervious SCS Curve No."			
"	0.482	Pervious Runoff coefficient"			
"	0.100	Pervious Ia/S coefficient"			
"	7.164	Pervious Initial abstraction"			
"	0.015	Impervious Manning 'n'"			
"	98.000	Impervious SCS Curve No."			
"	0.917	Impervious Runoff coefficient"			
"	0.100	Impervious Ia/S coefficient"			
"	0.518	Impervious Initial abstraction"			
"		0.129	0.000	0.058	0.260 c.m/sec"
"		Catchment 3200	Pervious	Impervious	Total Area "
"		Surface Area	0.212	0.318	0.530 hectare"
"		Time of concentration	19.958	2.738	7.208 minutes"
"		Time to Centroid	116.779	87.402	95.027 minutes"
"		Rainfall depth	86.737	86.737	86.737 mm"
"		Rainfall volume	183.88	275.82	459.70 c.m"
"		Rainfall losses	44.916	7.204	22.289 mm"
"		Runoff depth	41.821	79.533	64.448 mm"
"		Runoff volume	88.66	252.91	341.57 c.m"
"		Runoff coefficient	0.482	0.917	0.743 "
"		Maximum flow	0.029	0.120	0.129 c.m/sec"
" 40		HYDROGRAPH Add Runoff "			
"	4	Add Runoff "			
"		0.129	0.129	0.058	0.260"
" 33		CATCHMENT 3300"			
"	1	Triangular SCS"			
"	1	Equal length"			
"	1	SCS method"			
"	3300	Catchment 3300"			
"	60.000	% Impervious"			
"	0.240	Total Area"			
"	20.000	Flow length"			
"	2.000	Overland Slope"			
"	0.096	Pervious Area"			
"	20.000	Pervious length"			
"	2.000	Pervious slope"			
"	0.144	Impervious Area"			
"	20.000	Impervious length"			
"	2.000	Impervious slope"			
"	0.250	Pervious Manning 'n'"			
"	78.000	Pervious SCS Curve No."			
"	0.481	Pervious Runoff coefficient"			
"	0.100	Pervious Ia/S coefficient"			
"	7.164	Pervious Initial abstraction"			
"	0.015	Impervious Manning 'n'"			
"	98.000	Impervious SCS Curve No."			

			Post_50yr		
"	0.924	Impervious Runoff coefficient"			
"	0.100	Impervious Ia/S coefficient"			
"	0.518	Impervious Initial abstraction"			
"		0.064	0.129	0.058	0.260 c.m/sec"
"		Catchment 3300	Pervious	Impervious	Total Area "
"		Surface Area	0.096	0.144	0.240 hectare"
"		Time of concentration	10.695	1.467	3.845 minutes"
"		Time to Centroid	106.283	85.675	90.985 minutes"
"		Rainfall depth	86.737	86.737	86.737 mm"
"		Rainfall volume	83.27	124.90	208.17 c.m"
"		Rainfall losses	44.994	6.561	21.934 mm"
"		Runoff depth	41.743	80.176	64.803 mm"
"		Runoff volume	40.07	115.45	155.53 c.m"
"		Runoff coefficient	0.481	0.924	0.747 "
"		Maximum flow	0.016	0.054	0.064 c.m/sec"
" 40		HYDROGRAPH Add Runoff "			
"	4	Add Runoff "			
"		0.064	0.193	0.058	0.260"
" 40		HYDROGRAPH Copy to Outflow"			
"	8	Copy to Outflow"			
"		0.064	0.193	0.193	0.260"
" 40		HYDROGRAPH Combine 300"			
"	6	Combine "			
"	300	Node #"			
"		To Walser Street"			
"		Maximum flow	0.193		c.m/sec"
"		Hydrograph volume	497.101		c.m"
"		0.064	0.193	0.193	0.193"
" 40		HYDROGRAPH Confluence 300"			
"	7	Confluence "			
"	300	Node #"			
"		To Walser Street"			
"		Maximum flow	0.193		c.m/sec"
"		Hydrograph volume	497.100		c.m"
"		0.064	0.193	0.193	0.000"
" 40		HYDROGRAPH Copy to Outflow"			
"	8	Copy to Outflow"			
"		0.064	0.193	0.193	0.000"
" 40		HYDROGRAPH Combine 100"			
"	6	Combine "			
"	100	Node #"			
"		Existing wetland"			
"		Maximum flow	0.553		c.m/sec"
"		Hydrograph volume	7454.313		c.m"
"		0.064	0.193	0.193	0.553"
" 40		HYDROGRAPH Confluence 100"			
"	7	Confluence "			
"	100	Node #"			
"		Existing wetland"			
"		Maximum flow	0.553		c.m/sec"
"		Hydrograph volume	7454.313		c.m"
"		0.064	0.553	0.193	0.000"
" 40		HYDROGRAPH Copy to Outflow"			
"	8	Copy to Outflow"			
"		0.064	0.553	0.553	0.000"
" 40		HYDROGRAPH Combine 200"			
"	6	Combine "			
"	200	Node #"			
"		To Trib. of Grand River"			
"		Maximum flow	0.790		c.m/sec"
"		Hydrograph volume	10191.979		c.m"
"		0.064	0.553	0.553	0.790"
" 40		HYDROGRAPH Confluence 200"			

```

"                               Post__50yr
"       7  Confluence "
"       200 Node #"
"           To Trib. of Grand River"
"           Maximum flow           0.790    c.m/sec"
"           Hydrograph volume      10191.980 c.m"
"           0.064    0.790    0.553    0.000"
" 38  START/RE-START TOTALS 200"
"       3  Runoff Totals on EXIT"
"           Total Catchment area           22.640    hectare"
"           Total Impervious area         7.856    hectare"
"           Total % impervious           34.700"
" 19  EXIT"

```

```

"                                     Post__100yr
"                                     ----->"
"      MIDUSS Output ----->"
"      MIDUSS version                      Version 2.25 rev. 473"
"      MIDUSS created                      Sunday, February 07, 2010"
"      10  Units used:                      ie METRIC"
"      Job folder:                        w:\Kitchener\411-2011\411009\Design Data\
"                                     Modelling Files\2019-02-15"
"      Output filename:                    Post__100yr.out"
"      Licensee name:                      gmbp"
"      Company                            Hewlett-Packard Company"
"      Date & Time last used:              2/15/2019 at 4:01:17 PM"
" 31  TIME PARAMETERS"
"      5.000  Time Step"
"      180.000 Max. Storm length"
"      12000.000 Max. Hydrograph"
" 32  STORM Chicago storm"
"      1  Chicago storm"
"      6933.019 Coefficient A"
"      34.699  Constant B"
"      0.998  Exponent C"
"      0.380  Fraction R"
"      180.000 Duration"
"      1.000  Time step multiplier"
"      Maximum intensity          168.777  mm/hr"
"      Total depth                97.921  mm"
"      6  100hyd Hydrograph extension used in this file"
" 33  CATCHMENT 1200"
"      1  Triangular SCS"
"      1  Equal length"
"      1  SCS method"
"      1200  Catchment 1200"
"      50.000 % Impervious"
"      0.220  Total Area"
"      10.000 Flow length"
"      2.000  Overland slope"
"      0.110  Pervious Area"
"      10.000 Pervious length"
"      2.000  Pervious slope"
"      0.110  Impervious Area"
"      10.000 Impervious length"
"      2.000  Impervious slope"
"      0.250  Pervious Manning 'n'"
"      78.000 Pervious SCS Curve No."
"      0.511  Pervious Runoff coefficient"
"      0.100  Pervious Ia/S coefficient"
"      7.164  Pervious Initial abstraction"
"      0.015  Impervious Manning 'n'"
"      98.000 Impervious SCS Curve No."
"      0.908  Impervious Runoff coefficient"
"      0.100  Impervious Ia/S coefficient"
"      0.518  Impervious Initial abstraction"
"      0.063  0.000  0.000  0.000 c.m/sec"
"      Catchment 1200  Pervious  Impervious  Total Area  "
"      Surface Area    0.110    0.110    0.220    hectare"
"      Time of concentration  6.616    0.937    2.983    minutes"
"      Time to Centroid    101.199    85.009    90.841    minutes"
"      Rainfall depth     97.921    97.921    97.921    mm"
"      Rainfall volume    107.71    107.71    215.43    c.m"
"      Rainfall losses    47.838    8.977    28.408    mm"
"      Runoff depth       50.084    88.944    69.514    mm"
"      Runoff volume      55.09    97.84    152.93    c.m"
"      Runoff coefficient  0.511    0.908    0.710    "
"      Maximum flow      0.026    0.045    0.063    c.m/sec"
" 40  HYDROGRAPH Add Runoff "

```



```

Post__100yr
"      4  Add Runoff "
"      0.063      0.063      0.000      0.000"
" 33  CATCHMENT 1300"
"      1  Triangular SCS"
"      1  Equal length"
"      1  SCS method"
"      1300  Catchment 1300"
"      50.000  % Impervious"
"      0.840  Total Area"
"      20.000  Flow length"
"      2.000  Overland Slope"
"      0.420  Pervious Area"
"      20.000  Pervious length"
"      2.000  Pervious slope"
"      0.420  Impervious Area"
"      20.000  Impervious length"
"      2.000  Impervious slope"
"      0.250  Pervious Manning 'n'"
"      78.000  Pervious SCS Curve No."
"      0.515  Pervious Runoff coefficient"
"      0.100  Pervious Ia/S coefficient"
"      7.164  Pervious Initial abstraction"
"      0.015  Impervious Manning 'n'"
"      98.000  Impervious SCS Curve No."
"      0.931  Impervious Runoff coefficient"
"      0.100  Impervious Ia/S coefficient"
"      0.518  Impervious Initial abstraction"
"      0.233      0.063      0.000      0.000 c.m/sec"
"      Catchment 1300      Pervious      Impervious      Total Area "
"      Surface Area      0.420      0.420      0.840      hectare"
"      Time of concentration      10.027      1.421      4.487      minutes"
"      Time to Centroid      104.871      85.423      92.351      minutes"
"      Rainfall depth      97.921      97.921      97.921      mm"
"      Rainfall volume      411.27      411.27      822.54      c.m"
"      Rainfall losses      47.483      6.787      27.135      mm"
"      Runoff depth      50.438      91.134      70.786      mm"
"      Runoff volume      211.84      382.76      594.60      c.m"
"      Runoff coefficient      0.515      0.931      0.723      "
"      Maximum flow      0.088      0.173      0.233      c.m/sec"
" 40  HYDROGRAPH Add Runoff "
"      4  Add Runoff "
"      0.233      0.296      0.000      0.000"
" 33  CATCHMENT 1600"
"      1  Triangular SCS"
"      1  Equal length"
"      1  SCS method"
"      1600  Catchment 1600"
"      50.000  % Impervious"
"      0.360  Total Area"
"      15.000  Flow length"
"      2.000  Overland Slope"
"      0.180  Pervious Area"
"      15.000  Pervious length"
"      2.000  Pervious slope"
"      0.180  Impervious Area"
"      15.000  Impervious length"
"      2.000  Impervious slope"
"      0.250  Pervious Manning 'n'"
"      78.000  Pervious SCS Curve No."
"      0.516  Pervious Runoff coefficient"
"      0.100  Pervious Ia/S coefficient"
"      7.164  Pervious Initial abstraction"
"      0.015  Impervious Manning 'n'"

```

```

"                                     Post__100yr
" 98.000 Impervious SCS Curve No."
" 0.924 Impervious Runoff coefficient"
" 0.100 Impervious Ia/S coefficient"
" 0.518 Impervious Initial abstraction"
"      0.102      0.296      0.000      0.000 c.m/sec"
"      Catchment 1600      Pervious      Impervious      Total Area      "
"      Surface Area      0.180      0.180      0.360      hectare"
"      Time of concentration      8.438      1.196      3.791      minutes"
"      Time to Centroid      103.033      85.162      91.567      minutes"
"      Rainfall depth      97.921      97.921      97.921      mm"
"      Rainfall volume      176.26      176.26      352.52      c.m"
"      Rainfall losses      47.375      7.430      27.402      mm"
"      Runoff depth      50.546      90.491      70.519      mm"
"      Runoff volume      90.98      162.88      253.87      c.m"
"      Runoff coefficient      0.516      0.924      0.720      "
"      Maximum flow      0.041      0.074      0.102      c.m/sec"
" 40 HYDROGRAPH Add Runoff "
"      4 Add Runoff "
"      0.102      0.398      0.000      0.000"
" 54 POND DESIGN"
"      0.398 Current peak flow      c.m/sec"
"      0.250 Target outflow      c.m/sec"
"      1001.4 Hydrograph volume      c.m"
"      16. Number of stages"
"      411.830 Minimum water level      metre"
"      414.490 Maximum water level      metre"
"      411.830 Starting water level      metre"
"      0 Keep Design Data: 1 = True; 0 = False"
"      Level Discharge      Volume"
"      411.830      0.00033      0.000"
"      411.930      0.00033      19.920"
"      412.230      0.00034      143.570"
"      412.530      0.00035      267.220"
"      412.630      0.00035      287.130"
"      412.700      0.00035      301.070"
"      412.800      0.00035      301.140"
"      413.000      0.00035      301.260"
"      413.230      0.00035      301.400"
"      413.430      0.04510      301.740"
"      413.630      0.1310      302.400"
"      413.830      0.2461      303.400"
"      414.030      0.3862      304.740"
"      414.090      0.4327      305.240"
"      414.290      0.6461      307.240"
"      414.490      0.9189      309.570"
"      Peak outflow      0.378      c.m/sec"
"      Maximum level      414.041      metre"
"      Maximum storage      304.833      c.m"
"      Centroidal lag      26.012      hours"
"      0.102      0.398      0.378      0.000 c.m/sec"
" 40 HYDROGRAPH Combine      1"
"      6 Combine "
"      1 Node #"
"      Outlets to SWMF No. 1"
"      Maximum flow      0.378      c.m/sec"
"      Hydrograph volume      989.368      c.m"
"      0.102      0.398      0.378      0.378"
" 40 HYDROGRAPH Start - New Tributary"
"      2 Start - New Tributary"
"      0.102      0.000      0.378      0.378"
" 33 CATCHMENT 1400"
"      1 Triangular SCS"
"      1 Equal length"

```

Post__100yr

```

"      1  SCS method"
"      1400 Catchment 1400"
"      20.000 % Impervious"
"      0.620 Total Area"
"      30.000 Flow length"
"      2.000 Overland Slope"
"      0.496 Pervious Area"
"      30.000 Pervious length"
"      2.000 Pervious slope"
"      0.124 Impervious Area"
"      30.000 Impervious length"
"      2.000 Impervious slope"
"      0.250 Pervious Manning 'n'"
"      78.000 Pervious SCS Curve No."
"      0.516 Pervious Runoff coefficient"
"      0.100 Pervious Ia/S coefficient"
"      7.164 Pervious Initial abstraction"
"      0.015 Impervious Manning 'n'"
"      98.000 Impervious SCS Curve No."
"      0.932 Impervious Runoff coefficient"
"      0.100 Impervious Ia/S coefficient"
"      0.518 Impervious Initial abstraction"
"      0.129 0.000 0.378 0.378 c.m/sec"
"      Catchment 1400 Pervious Impervious Total Area "
"      Surface Area 0.496 0.124 0.620 hectare"
"      Time of concentration 12.789 1.812 9.373 minutes"
"      Time to Centroid 107.990 85.865 101.105 minutes"
"      Rainfall depth 97.921 97.921 97.921 mm"
"      Rainfall volume 485.69 121.42 607.11 c.m"
"      Rainfall losses 47.421 6.662 39.270 mm"
"      Runoff depth 50.500 91.259 58.652 mm"
"      Runoff volume 250.48 113.16 363.64 c.m"
"      Runoff coefficient 0.516 0.932 0.599 "
"      Maximum flow 0.098 0.051 0.129 c.m/sec"
" 40 HYDROGRAPH Add Runoff "
"      4 Add Runoff "
"      0.129 0.129 0.378 0.378"
" 54 POND DESIGN"
"      0.129 Current peak flow c.m/sec"
"      0.250 Target outflow c.m/sec"
"      363.6 Hydrograph volume c.m"
"      17. Number of stages"
"      413.920 Minimum water level metre"
"      415.520 Maximum water level metre"
"      413.920 Starting water level metre"
"      0 Keep Design Data: 1 = True; 0 = False"
"      Level Discharge Volume"
"      413.920 0.00089 0.000"
"      414.020 0.00089 26.670"
"      414.120 0.00090 54.610"
"      414.220 0.00090 82.540"
"      414.320 0.00090 110.480"
"      414.420 0.00091 138.420"
"      414.520 0.00091 165.090"
"      414.620 0.00091 191.760"
"      414.720 0.00091 191.830"
"      414.820 0.02640 191.900"
"      414.920 0.03734 191.970"
"      415.020 0.04573 192.040"
"      415.120 0.05281 192.120"
"      415.220 0.2777 201.400"
"      415.320 0.6941 238.900"
"      415.420 1.244 304.650"

```

			Post__100yr		
"	415.520	1.909	382.150"		
"	Peak outflow		0.090	c.m/sec"	
"	Maximum level		415.136	metre"	
"	Maximum storage		193.651	c.m"	
"	Centroidal lag		18.597	hours"	
"	0.129	0.129	0.090	0.378	c.m/sec"
40	HYDROGRAPH Next link "				
"	5 Next link "				
"	0.129	0.090	0.090	0.378"	
33	CATCHMENT 1500"				
"	1 Triangular SCS"				
"	1 Equal length"				
"	1 SCS method"				
"	1500 Catchment 1500"				
"	50.000 % Impervious"				
"	1.110 Total Area"				
"	40.000 Flow length"				
"	2.000 Overland Slope"				
"	0.555 Pervious Area"				
"	40.000 Pervious length"				
"	2.000 Pervious slope"				
"	0.555 Impervious Area"				
"	40.000 Impervious length"				
"	2.000 Impervious slope"				
"	0.250 Pervious Manning 'n'"				
"	78.000 Pervious SCS Curve No."				
"	0.517 Pervious Runoff coefficient"				
"	0.100 Pervious Ia/S coefficient"				
"	7.164 Pervious Initial abstraction"				
"	0.015 Impervious Manning 'n'"				
"	98.000 Impervious SCS Curve No."				
"	0.929 Impervious Runoff coefficient"				
"	0.100 Impervious Ia/S coefficient"				
"	0.518 Impervious Initial abstraction"				
"	0.277	0.090	0.090	0.378	c.m/sec"
"	Catchment 1500	Pervious	Impervious	Total Area	"
"	Surface Area	0.555	0.555	1.110	hectare"
"	Time of concentration	15.199	2.153	6.817	minutes"
"	Time to Centroid	110.688	86.345	95.048	minutes"
"	Rainfall depth	97.921	97.921	97.921	mm"
"	Rainfall volume	543.46	543.46	1086.93	c.m"
"	Rainfall losses	47.301	6.948	27.124	mm"
"	Runoff depth	50.621	90.973	70.797	mm"
"	Runoff volume	280.94	504.90	785.85	c.m"
"	Runoff coefficient	0.517	0.929	0.723	"
"	Maximum flow	0.105	0.230	0.277	c.m/sec"
40	HYDROGRAPH Add Runoff "				
"	4 Add Runoff "				
"	0.277	0.278	0.090	0.378"	
56	DIVERSION"				
"	1500 Node number"				
"	0.146 Overflow threshold"				
"	1.000 Required diverted fraction"				
"	0 Conduit type; 1=Pipe;2=Channel"				
"	Peak of diverted flow		0.132	c.m/sec"	
"	Volume of diverted flow		191.312	c.m"	
"	DIV01500.100hyd"				
"	Major flow at 1500"				
"	0.277	0.278	0.146	0.378	c.m/sec"
40	HYDROGRAPH Next link "				
"	5 Next link "				
"	0.277	0.146	0.146	0.378"	
33	CATCHMENT 1000"				

```

"      1 Triangular SCS"
"      1 Equal length"
"      1 SCS method"
"    1000 Catchment 1000"
"    50.000 % Impervious"
"     6.760 Total Area"
"   100.000 Flow length"
"     2.000 Overland Slope"
"     3.380 Pervious Area"
"   100.000 Pervious length"
"     2.000 Pervious slope"
"     3.380 Impervious Area"
"   100.000 Impervious length"
"     2.000 Impervious slope"
"     0.250 Pervious Manning 'n'"
"    78.000 Pervious SCS Curve No."
"     0.517 Pervious Runoff coefficient"
"     0.100 Pervious Ia/S coefficient"
"     7.164 Pervious Initial abstraction"
"     0.015 Impervious Manning 'n'"
"   98.000 Impervious SCS Curve No."
"     0.926 Impervious Runoff coefficient"
"     0.100 Impervious Ia/S coefficient"
"     0.518 Impervious Initial abstraction"
"           1.559      0.146      0.146      0.378 c.m/sec"
"   Catchment 1000      Pervious      Impervious      Total Area "
"   Surface Area      3.380      3.380      6.760      hectare"
"   Time of concentration      26.337      3.732      11.833      minutes"
"   Time to Centroid      123.197      88.516      100.945      minutes"
"   Rainfall depth      97.921      97.921      97.921      mm"
"   Rainfall volume      3309.74      3309.74      6619.48      c.m"
"   Rainfall losses      47.249      7.203      27.226      mm"
"   Runoff depth      50.672      90.719      70.695      mm"
"   Runoff volume      1712.72      3066.29      4779.01      c.m"
"   Runoff coefficient      0.517      0.926      0.722      "
"   Maximum flow      0.482      1.442      1.559      c.m/sec"
" 40 HYDROGRAPH Add Runoff "
"     4 Add Runoff "
"           1.559      1.705      0.146      0.378"
" 33 CATCHMENT 1100"
"     1 Triangular SCS"
"     1 Equal length"
"     1 SCS method"
"    1100 Catchment 1100"
"     0.000 % Impervious"
"     0.480 Total Area"
"    20.000 Flow length"
"     2.000 Overland Slope"
"     0.480 Pervious Area"
"    20.000 Pervious length"
"     2.000 Pervious slope"
"     0.000 Impervious Area"
"    20.000 Impervious length"
"     2.000 Impervious slope"
"     0.250 Pervious Manning 'n'"
"    78.000 Pervious SCS Curve No."
"     0.515 Pervious Runoff coefficient"
"     0.100 Pervious Ia/S coefficient"
"     7.164 Pervious Initial abstraction"
"     0.015 Impervious Manning 'n'"
"   98.000 Impervious SCS Curve No."
"     0.000 Impervious Runoff coefficient"
"     0.100 Impervious Ia/S coefficient"

```

```

"         Post__100yr
" 0.518 Impervious Initial abstraction"
"         0.101 1.705 0.146 0.378 c.m/sec"
" Catchment 1100 Pervious Impervious Total Area "
" Surface Area 0.480 0.000 0.480 hectare"
" Time of concentration 10.027 1.421 10.027 minutes"
" Time to Centroid 104.871 85.423 104.871 minutes"
" Rainfall depth 97.921 97.921 97.921 mm"
" Rainfall volume 470.02 0.00 470.02 c.m"
" Rainfall losses 47.483 6.787 47.483 mm"
" Runoff depth 50.438 91.134 50.438 mm"
" Runoff volume 242.10 0.00 242.10 c.m"
" Runoff coefficient 0.515 0.000 0.515 "
" Maximum flow 0.101 0.000 0.101 c.m/sec"
" 40 HYDROGRAPH Add Runoff "
" 4 Add Runoff "
"         0.101 1.779 0.146 0.378"
" 40 HYDROGRAPH Copy to Outflow"
" 8 Copy to Outflow"
"         0.101 1.779 1.779 0.378"
" 40 HYDROGRAPH Combine 1"
" 6 Combine "
" 1 Node #"
" Outlets to SWMF No. 1"
" Maximum flow 2.157 c.m/sec"
" Hydrograph volume 6975.535 c.m"
"         0.101 1.779 1.779 2.157"
" 40 HYDROGRAPH Confluence 1"
" 7 Confluence "
" 1 Node #"
" Outlets to SWMF No. 1"
" Maximum flow 2.157 c.m/sec"
" Hydrograph volume 6975.535 c.m"
"         0.101 2.157 1.779 0.000"
" 54 POND DESIGN"
" 2.157 Current peak flow c.m/sec"
" 0.250 Target outflow c.m/sec"
" 6975.5 Hydrograph volume c.m"
" 11. Number of stages"
" 411.000 Minimum water level metre"
" 412.000 Maximum water level metre"
" 411.000 Starting water level metre"
" 0 Keep Design Data: 1 = True; 0 = False"
" Level Discharge Volume"
" 411.000 0.000 0.000"
" 411.100 0.05100 425.000"
" 411.200 0.1030 936.000"
" 411.300 0.1190 1459.000"
" 411.400 0.1330 1994.000"
" 411.500 0.3220 2542.000"
" 411.600 0.3510 3101.000"
" 411.700 0.3780 3673.000"
" 411.800 0.4030 4258.000"
" 411.850 0.4150 4554.000"
" 412.000 2.088 5464.000"
" Peak outflow 0.399 c.m/sec"
" Maximum level 411.786 metre"
" Maximum storage 4174.798 c.m"
" Centroidal lag 8.702 hours"
"         0.101 2.157 0.399 0.000 c.m/sec"
" 40 HYDROGRAPH Next link "
" 5 Next link "
"         0.101 0.399 0.399 0.000"
" 47 FILEI_O Read/Open DIV01500.100hyd"

```

```

Post__100yr
" 1 1=read/open; 2=write/save"
" 2 1=rainfall; 2=hydrograph"
" 1 1=runoff; 2=inflow; 3=outflow; 4=junction"
" DIV01500.100hyd"
" Major flow at 1500"
" Total volume 191.312 c.m"
" Maximum flow 0.132 c.m/sec"
" 0.132 0.399 0.399 0.000 c.m/sec"
40 HYDROGRAPH Add Runoff "
" 4 Add Runoff "
" 0.132 0.455 0.399 0.000"
33 CATCHMENT 4000"
" 1 Triangular SCS"
" 1 Equal length"
" 1 SCS method"
" 4000 Catchment 4000"
" 0.000 % Impervious"
" 7.330 Total Area"
" 60.000 Flow length"
" 2.000 Overland Slope"
" 7.330 Pervious Area"
" 60.000 Pervious length"
" 2.000 Pervious slope"
" 0.000 Impervious Area"
" 60.000 Impervious length"
" 2.000 Impervious slope"
" 0.250 Pervious Manning 'n'"
" 50.000 Pervious SCS Curve No."
" 0.164 Pervious Runoff coefficient"
" 0.100 Pervious Ia/S coefficient"
" 25.400 Pervious Initial abstraction"
" 0.015 Impervious Manning 'n'"
" 98.000 Impervious SCS Curve No."
" 0.000 Impervious Runoff coefficient"
" 0.100 Impervious Ia/S coefficient"
" 0.518 Impervious Initial abstraction"
" 0.268 0.455 0.399 0.000 c.m/sec"
" Catchment 4000 Pervious Impervious Total Area "
" Surface Area 7.330 0.000 7.330 hectare"
" Time of concentration 32.980 2.747 32.980 minutes"
" Time to Centroid 137.344 87.189 137.344 minutes"
" Rainfall depth 97.921 97.921 97.921 mm"
" Rainfall volume 7177.62 0.01 7177.63 c.m"
" Rainfall losses 81.821 7.496 81.821 mm"
" Runoff depth 16.100 90.426 16.100 mm"
" Runoff volume 1180.13 0.01 1180.14 c.m"
" Runoff coefficient 0.164 0.000 0.164 "
" Maximum flow 0.268 0.000 0.268 c.m/sec"
40 HYDROGRAPH Add Runoff "
" 4 Add Runoff "
" 0.268 0.671 0.399 0.000"
54 POND DESIGN"
" 0.671 Current peak flow c.m/sec"
" 0.250 Target outflow c.m/sec"
" 8342.3 Hydrograph volume c.m"
" 6. Number of stages"
" 409.630 Minimum water level metre"
" 410.750 Maximum water level metre"
" 409.630 Starting water level metre"
" 0 Keep Design Data: 1 = True; 0 = False"
" Level Discharge Volume"
" 409.630 0.000 0.000"
" 409.750 0.6650 402.200"

```

```

"                                     Post__100yr
"           410.000      3.601  2187.900"
"           410.250      7.811  5318.900"
"           410.500     12.984  9642.300"
"           410.750     18.965 15227.70"
"           Peak outflow                0.633   c.m/sec"
"           Maximum level                409.744  metre"
"           Maximum storage              382.968   c.m"
"           Centroidal lag              7.790    hours"
"           0.268      0.671      0.633      0.000 c.m/sec"
40  HYDROGRAPH Next link "
"     5  Next link "
"           0.268      0.633      0.633      0.000"
52  CHANNEL DESIGN"
"     0.633  Current peak flow   c.m/sec"
"     0.035  Manning 'n'"
"     0.     Cross-section type: 0=trapezoidal; 1=general"
"     0.000  Basewidth   metre"
"     7.410  Left bank slope"
"     6.000  Right bank slope"
"     0.950  Channel depth  metre"
"     1.040  Gradient    %"
"           Depth of flow                0.330   metre"
"           Velocity                    0.869   m/sec"
"           Channel capacity             10.655  c.m/sec"
"           Critical depth              0.283   metre"
53  ROUTE   Channel Route 72"
"     72.40  Channel Route 72 Reach length ( metre)"
"     0.418  X-factor <= 0.5"
"     62.466 K-lag   ( seconds)"
"     0.000  Default(0) or user spec.(1) values used"
"     0.500  X-factor <= 0.5"
"     30.000 K-lag   ( seconds)"
"     0.500  Beta weighting factor"
"     60.000 Routing time step ( seconds)"
"     1     No. of sub-reaches"
"           Peak outflow                0.632   c.m/sec"
"           0.268      0.633      0.632      0.000 c.m/sec"
40  HYDROGRAPH Next link "
"     5  Next link "
"           0.268      0.632      0.632      0.000"
52  CHANNEL DESIGN"
"     0.632  Current peak flow   c.m/sec"
"     0.035  Manning 'n'"
"     0.     Cross-section type: 0=trapezoidal; 1=general"
"     2.000  Basewidth   metre"
"     2.950  Left bank slope"
"     3.000  Right bank slope"
"     0.950  Channel depth  metre"
"     1.040  Gradient    %"
"           Depth of flow                0.243   metre"
"           Velocity                    0.955   m/sec"
"           Channel capacity             9.246   c.m/sec"
"           Critical depth              0.196   metre"
53  ROUTE   Channel Route 40"
"     39.80  Channel Route 40 Reach length ( metre)"
"     0.339  X-factor <= 0.5"
"     31.251 K-lag   ( seconds)"
"     0.000  Default(0) or user spec.(1) values used"
"     0.500  X-factor <= 0.5"
"     30.000 K-lag   ( seconds)"
"     0.500  Beta weighting factor"
"     37.500 Routing time step ( seconds)"
"     1     No. of sub-reaches"

```



```

"          Post__100yr
"          Peak outflow          0.632      c.m/sec"
"          0.268      0.632      0.632      0.000 c.m/sec"
40  HYDROGRAPH Combine 100"
"      6  Combine "
"      100 Node #"
"          Existing wetland"
"          Maximum flow          0.632      c.m/sec"
"          Hydrograph volume      8342.053  c.m"
"          0.268      0.632      0.632      0.632"
40  HYDROGRAPH Start - New Tributary"
"      2  Start - New Tributary"
"          0.268      0.000      0.632      0.632"
33  CATCHMENT 2100"
"      1  Triangular SCS"
"      1  Equal length"
"      1  SCS method"
"      2100 Catchment 2100"
"      60.000 % Impervious"
"      1.960 Total Area"
"      40.000 Flow length"
"      2.000 Overland Slope"
"      0.784 Pervious Area"
"      40.000 Pervious length"
"      2.000 Pervious slope"
"      1.176 Impervious Area"
"      40.000 Impervious length"
"      2.000 Impervious slope"
"      0.250 Pervious Manning 'n'"
"      78.000 Pervious SCS Curve No."
"      0.517 Pervious Runoff coefficient"
"      0.100 Pervious Ia/S coefficient"
"      7.164 Pervious Initial abstraction"
"      0.015 Impervious Manning 'n'"
"      98.000 Impervious SCS Curve No."
"      0.929 Impervious Runoff coefficient"
"      0.100 Impervious Ia/S coefficient"
"      0.518 Impervious Initial abstraction"
"          0.554      0.000      0.632      0.632 c.m/sec"
"          Catchment 2100 Pervious Impervious Total Area "
"          Surface Area      0.784      1.176      1.960      hectare"
"          Time of concentration 15.199      2.153      5.683      minutes"
"          Time to Centroid      110.688      86.345      92.932      minutes"
"          Rainfall depth      97.921      97.921      97.921      mm"
"          Rainfall volume      767.70      1151.55      1919.26      c.m"
"          Rainfall losses      47.301      6.948      23.089      mm"
"          Runoff depth      50.621      90.973      74.832      mm"
"          Runoff volume      396.87      1069.84      1466.71      c.m"
"          Runoff coefficient      0.517      0.929      0.764      "
"          Maximum flow      0.148      0.488      0.554      c.m/sec"
40  HYDROGRAPH Add Runoff "
"      4  Add Runoff "
"          0.554      0.554      0.632      0.632"
33  CATCHMENT 2400"
"      1  Triangular SCS"
"      1  Equal length"
"      1  SCS method"
"      2400 Catchment 2400"
"      90.000 % Impervious"
"      0.790 Total Area"
"      20.000 Flow length"
"      2.000 Overland Slope"
"      0.079 Pervious Area"
"      20.000 Pervious length"

```

```

Post__100yr
"      2.000 Pervious slope"
"      0.711 Impervious Area"
"     20.000 Impervious length"
"      2.000 Impervious slope"
"      0.250 Pervious Manning 'n'"
"     78.000 Pervious SCS Curve No."
"      0.515 Pervious Runoff coefficient"
"      0.100 Pervious Ia/S coefficient"
"      7.164 Pervious Initial abstraction"
"      0.015 Impervious Manning 'n'"
"     98.000 Impervious SCS Curve No."
"      0.931 Impervious Runoff coefficient"
"      0.100 Impervious Ia/S coefficient"
"      0.518 Impervious Initial abstraction"
"          0.297      0.554      0.632      0.632 c.m/sec"
"      Catchment 2400 Pervious Impervious Total Area "
"      Surface Area      0.079      0.711      0.790 hectare"
"      Time of concentration 10.027      1.421      1.919 minutes"
"      Time to Centroid 104.871      85.423      86.549 minutes"
"      Rainfall depth 97.921      97.921      97.921 mm"
"      Rainfall volume 77.36      696.22      773.58 c.m"
"      Rainfall losses 47.483      6.787      10.857 mm"
"      Runoff depth 50.438      91.134      87.065 mm"
"      Runoff volume 39.85      647.96      687.81 c.m"
"      Runoff coefficient 0.515      0.931      0.889 "
"      Maximum flow 0.017      0.292      0.297 c.m/sec"
40 HYDROGRAPH Add Runoff "
"      4 Add Runoff "
"          0.297      0.850      0.632      0.632"
54 POND DESIGN"
"      0.850 Current peak flow c.m/sec"
"      0.020 Target outflow c.m/sec"
"     2154.5 Hydrograph volume c.m"
"      13. Number of stages"
"     410.650 Minimum water level metre"
"     411.950 Maximum water level metre"
"     410.650 Starting water level metre"
"      0 Keep Design Data: 1 = True; 0 = False"
"          Level Discharge Volume"
"     410.650 0.000 0.000"
"     410.700 0.00600 42.000"
"     410.800 0.01300 130.000"
"     410.900 0.02000 225.000"
"     411.000 0.02500 328.000"
"     411.100 0.02900 439.000"
"     411.200 0.1260 558.000"
"     411.300 0.1390 686.000"
"     411.400 0.1510 822.000"
"     411.500 0.1630 967.000"
"     411.600 0.1730 1121.000"
"     411.650 0.1780 1202.000"
"     411.950 2.575 1742.000"
"      Peak outflow 0.289 c.m/sec"
"      Maximum level 411.664 metre"
"      Maximum storage 1227.028 c.m"
"      Centroidal lag 3.461 hours"
"          0.297      0.850      0.289      0.632 c.m/sec"
40 HYDROGRAPH Next link "
"      5 Next link "
"          0.297      0.289      0.289      0.632"
33 CATCHMENT 2300"
"      1 Triangular SCS"
"      1 Equal length"

```

Post__100yr

```

"      1 SCS method"
"      2300 Catchment 2300"
"     10.000 % Impervious"
"      0.480 Total Area"
"     20.000 Flow length"
"      2.000 Overland Slope"
"      0.432 Pervious Area"
"     20.000 Pervious length"
"      2.000 Pervious slope"
"      0.048 Impervious Area"
"     20.000 Impervious length"
"      2.000 Impervious slope"
"      0.250 Pervious Manning 'n'"
"     78.000 Pervious SCS Curve No."
"      0.515 Pervious Runoff coefficient"
"      0.100 Pervious Ia/S coefficient"
"      7.164 Pervious Initial abstraction"
"      0.015 Impervious Manning 'n'"
"     98.000 Impervious SCS Curve No."
"      0.931 Impervious Runoff coefficient"
"      0.100 Impervious Ia/S coefficient"
"      0.518 Impervious Initial abstraction"
"          0.105      0.289      0.289      0.632 c.m/sec"
"      Catchment 2300      Pervious      Impervious      Total Area      "
"      Surface Area      0.432      0.048      0.480      hectare"
"      Time of concentration      10.027      1.421      8.588      minutes"
"      Time to Centroid      104.871      85.423      101.619      minutes"
"      Rainfall depth      97.921      97.921      97.921      mm"
"      Rainfall volume      423.02      47.00      470.02      c.m"
"      Rainfall losses      47.483      6.787      43.413      mm"
"      Runoff depth      50.438      91.134      54.508      mm"
"      Runoff volume      217.89      43.74      261.64      c.m"
"      Runoff coefficient      0.515      0.931      0.557      "
"      Maximum flow      0.091      0.020      0.105      c.m/sec"
" 40      HYDROGRAPH Add Runoff "
"      4      Add Runoff "
"          0.105      0.338      0.289      0.632"
" 40      HYDROGRAPH Copy to Outflow"
"      8      Copy to Outflow"
"          0.105      0.338      0.338      0.632"
" 40      HYDROGRAPH Combine 200"
"      6      Combine "
"     200      Node #"
"          To Trib. of Grand River"
"          Maximum flow      0.338      c.m/sec"
"          Hydrograph volume      2407.782      c.m"
"          0.105      0.338      0.338      0.338"
" 40      HYDROGRAPH Start - New Tributary"
"      2      Start - New Tributary"
"          0.105      0.000      0.338      0.338"
" 33      CATCHMENT 2200"
"      1      Triangular SCS"
"      1      Equal length"
"      1      SCS method"
"     2200      Catchment 2200"
"     75.000      % Impervious"
"      0.920      Total Area"
"     40.000      Flow length"
"      2.000      Overland Slope"
"      0.230      Pervious Area"
"     40.000      Pervious length"
"      2.000      Pervious slope"
"      0.690      Impervious Area"

```

```

Post__100yr
" 40.000 Impervious length"
" 2.000 Impervious slope"
" 0.250 Pervious Manning 'n'"
" 78.000 Pervious SCS Curve No."
" 0.517 Pervious Runoff coefficient"
" 0.100 Pervious Ia/S coefficient"
" 7.164 Pervious Initial abstraction"
" 0.015 Impervious Manning 'n'"
" 98.000 Impervious SCS Curve No."
" 0.929 Impervious Runoff coefficient"
" 0.100 Impervious Ia/S coefficient"
" 0.518 Impervious Initial abstraction"
" 0.306 0.000 0.338 0.338 c.m/sec"
" Catchment 2200 Pervious Impervious Total Area "
" Surface Area 0.230 0.690 0.920 hectare"
" Time of concentration 15.199 2.153 4.194 minutes"
" Time to Centroid 110.688 86.345 90.153 minutes"
" Rainfall depth 97.921 97.921 97.921 mm"
" Rainfall volume 225.22 675.66 900.88 c.m"
" Rainfall losses 47.301 6.948 17.036 mm"
" Runoff depth 50.621 90.973 80.885 mm"
" Runoff volume 116.43 627.71 744.14 c.m"
" Runoff coefficient 0.517 0.929 0.826 "
" Maximum flow 0.043 0.286 0.306 c.m/sec"
40 HYDROGRAPH Add Runoff "
4 Add Runoff "
" 0.306 0.306 0.338 0.338"
54 POND DESIGN"
0.306 Current peak flow c.m/sec"
0.756 Target outflow c.m/sec"
744.1 Hydrograph volume c.m"
12. Number of stages"
413.700 Minimum water level metre"
415.000 Maximum water level metre"
413.700 Starting water level metre"
0 Keep Design Data: 1 = True; 0 = False"
Level Discharge volume"
413.700 0.000 0.000"
413.800 0.00500 88.600"
413.900 0.01000 187.200"
414.000 0.01300 298.400"
414.100 0.01500 422.200"
414.200 0.2220 558.900"
414.300 0.2590 708.500"
414.400 0.2910 871.100"
414.500 0.3210 1046.900"
414.600 0.3470 1236.100"
414.700 0.3720 1438.700"
415.000 2.808 2087.400"
Peak outflow 0.093 c.m/sec"
Maximum level 414.138 metre"
Maximum storage 473.926 c.m"
Centroidal lag 6.054 hours"
0.306 0.306 0.093 0.338 c.m/sec"
40 HYDROGRAPH Combine 200"
6 Combine "
200 Node #"
To Trib. of Grand River"
Maximum flow 0.431 c.m/sec"
Hydrograph volume 3153.250 c.m"
0.306 0.306 0.093 0.431"
40 HYDROGRAPH Start - New Tributary"
2 Start - New Tributary"

```

			Post__100yr		
"	0.306	0.000	0.093	0.431"	
" 33	CATCHMENT 3200"				
"	1	Triangular SCS"			
"	1	Equal length"			
"	1	SCS method"			
"	3200	Catchment 3200"			
"	60.000	% Impervious"			
"	0.530	Total Area"			
"	40.000	Flow length"			
"	1.000	Overland Slope"			
"	0.212	Pervious Area"			
"	40.000	Pervious length"			
"	1.000	Pervious slope"			
"	0.318	Impervious Area"			
"	40.000	Impervious length"			
"	1.000	Impervious slope"			
"	0.250	Pervious Manning 'n'"			
"	78.000	Pervious SCS Curve No."			
"	0.517	Pervious Runoff coefficient"			
"	0.100	Pervious Ia/S coefficient"			
"	7.164	Pervious Initial abstraction"			
"	0.015	Impervious Manning 'n'"			
"	98.000	Impervious SCS Curve No."			
"	0.924	Impervious Runoff coefficient"			
"	0.100	Impervious Ia/S coefficient"			
"	0.518	Impervious Initial abstraction"			
"	0.144	0.000	0.093	0.431 c.m/sec"	
"	Catchment 3200	Pervious	Impervious	Total Area	"
"	Surface Area	0.212	0.318	0.530	hectare"
"	Time of concentration	18.712	2.651	7.014	minutes"
"	Time to Centroid	114.625	87.045	94.538	minutes"
"	Rainfall depth	97.921	97.921	97.921	mm"
"	Rainfall volume	207.59	311.39	518.98	c.m"
"	Rainfall losses	47.295	7.442	23.384	mm"
"	Runoff depth	50.626	90.479	74.538	mm"
"	Runoff volume	107.33	287.72	395.05	c.m"
"	Runoff coefficient	0.517	0.924	0.761	"
"	Maximum flow	0.036	0.131	0.144	c.m/sec"
" 40	HYDROGRAPH Add Runoff "				
"	4	Add Runoff "			
"	0.144	0.144	0.093	0.431"	
" 33	CATCHMENT 3300"				
"	1	Triangular SCS"			
"	1	Equal length"			
"	1	SCS method"			
"	3300	Catchment 3300"			
"	60.000	% Impervious"			
"	0.240	Total Area"			
"	20.000	Flow length"			
"	2.000	Overland Slope"			
"	0.096	Pervious Area"			
"	20.000	Pervious length"			
"	2.000	Pervious slope"			
"	0.144	Impervious Area"			
"	20.000	Impervious length"			
"	2.000	Impervious slope"			
"	0.250	Pervious Manning 'n'"			
"	78.000	Pervious SCS Curve No."			
"	0.515	Pervious Runoff coefficient"			
"	0.100	Pervious Ia/S coefficient"			
"	7.164	Pervious Initial abstraction"			
"	0.015	Impervious Manning 'n'"			
"	98.000	Impervious SCS Curve No."			

```

"          7 Confluence "          Post__100yr
"          200 Node #"
"          To Trib. of Grand River"
"          Maximum flow          1.046      c.m/sec"
"          Hydrograph volume      12070.033  c.m"
"          0.072      1.046      0.675      0.000"
" 38 START/RE-START TOTALS 200"
"          3 Runoff Totals on EXIT"
"          Total Catchment area          22.640      hectare"
"          Total Impervious area          7.856      hectare"
"          Total % impervious          34.700"
" 19 EXIT"

```

```

"                                     Post__REG
"
" MIDUSS Output ----->
" MIDUSS version                      Version 2.25 rev. 473"
" MIDUSS created                      Sunday, February 07, 2010"
" 10 Units used:                      ie METRIC"
" Job folder:                        w:\Kitchener\411-2011\411009\Design Data\
"                                     Modelling Files\2019-02-15"
"
" Output filename:                    Post__REG.out"
" Licensee name:                      gmbp"
" Company                             Hewlett-Packard Company"
" Date & Time last used:              2/15/2019 at 4:05:13 PM"
" 31 TIME PARAMETERS"
" 60.000 Time Step"
" 2880.000 Max. Storm length"
" 12000.000 Max. Hydrograph"
" 32 STORM Historic"
" 5 Historic"
" 2880.000 Duration"
" 48.000 Rainfall intensity values"
"      2.028      2.028      2.028      2.028      2.028"
"      2.028      2.028      2.028      2.028      2.028"
"      2.028      2.028      2.028      2.028      2.028"
"      2.028      2.028      2.028      2.028      2.028"
"      2.028      2.028      2.028      2.028      2.028"
"      2.028      2.026      2.026      2.026      2.028"
"      2.026      6.000      4.000      6.000      13.000"
"      17.000     13.000     23.000     13.000     13.000"
"      53.000     38.000     13.000"
"      Maximum intensity          53.000 mm/hr"
"      Total depth                285.000 mm"
" 6 000hyd Hydrograph extension used in this file"
" 33 CATCHMENT 1200"
" 1 Triangular SCS"
" 1 Equal length"
" 1 SCS method"
" 1200 Catchment 1200"
" 50.000 % Impervious"
" 0.220 Total Area"
" 10.000 Flow length"
" 2.000 Overland Slope"
" 0.110 Pervious Area"
" 10.000 Pervious length"
" 2.000 Pervious slope"
" 0.110 Impervious Area"
" 10.000 Impervious length"
" 2.000 Impervious slope"
" 0.250 Pervious Manning 'n'"
" 78.000 Pervious SCS Curve No."
" 0.719 Pervious Runoff coefficient"
" 0.100 Pervious Ia/S coefficient"
" 7.164 Pervious Initial abstraction"
" 0.015 Impervious Manning 'n'"
" 98.000 Impervious SCS Curve No."
" 0.846 Impervious Runoff coefficient"
" 0.100 Impervious Ia/S coefficient"
" 0.518 Impervious Initial abstraction"
"      0.027      0.000      0.000      0.000 c.m/sec"
" Catchment 1200 Pervious Impervious Total Area "
" Surface Area      0.110      0.110      0.220 hectare"
" Time of concentration 8.237      1.480      4.583 minutes"
" Time to Centroid 2489.666      2307.003      2390.883 minutes"
" Rainfall depth      285.000      285.000      285.000 mm"
" Rainfall volume      313.50      313.50      627.00 c.m"

```

		Post__REG			
"	Rainfall losses	80.153	43.756	61.955	mm"
"	Runoff depth	204.847	241.244	223.045	mm"
"	Runoff volume	225.33	265.37	490.70	c.m"
"	Runoff coefficient	0.719	0.846	0.783	"
"	Maximum flow	0.013	0.014	0.027	c.m/sec"
" 40	HYDROGRAPH Add Runoff "				
"	4 Add Runoff "				
"		0.027	0.027	0.000	0.000"
" 33	CATCHMENT 1300"				
"	1 Triangular SCS"				
"	1 Equal length"				
"	1 SCS method"				
"	1300 Catchment 1300"				
"	50.000 % Impervious"				
"	0.840 Total Area"				
"	20.000 Flow length"				
"	2.000 Overland Slope"				
"	0.420 Pervious Area"				
"	20.000 Pervious length"				
"	2.000 Pervious slope"				
"	0.420 Impervious Area"				
"	20.000 Impervious length"				
"	2.000 Impervious slope"				
"	0.250 Pervious Manning 'n'"				
"	78.000 Pervious SCS Curve No."				
"	0.754 Pervious Runoff coefficient"				
"	0.100 Pervious Ia/S coefficient"				
"	7.164 Pervious Initial abstraction"				
"	0.015 Impervious Manning 'n'"				
"	98.000 Impervious SCS Curve No."				
"	0.846 Impervious Runoff coefficient"				
"	0.100 Impervious Ia/S coefficient"				
"	0.518 Impervious Initial abstraction"				
"		0.102	0.027	0.000	0.000 c.m/sec"
"	Catchment 1300	Pervious	Impervious	Total Area	"
"	Surface Area	0.420	0.420	0.840	hectare"
"	Time of concentration	12.485	2.243	7.071	minutes"
"	Time to Centroid	2505.276	2290.972	2391.991	minutes"
"	Rainfall depth	285.000	285.000	285.000	mm"
"	Rainfall volume	1197.00	1197.00	2394.00	c.m"
"	Rainfall losses	70.073	43.972	57.023	mm"
"	Runoff depth	214.927	241.028	227.977	mm"
"	Runoff volume	902.69	1012.32	1915.01	c.m"
"	Runoff coefficient	0.754	0.846	0.800	"
"	Maximum flow	0.048	0.054	0.102	c.m/sec"
" 40	HYDROGRAPH Add Runoff "				
"	4 Add Runoff "				
"		0.102	0.129	0.000	0.000"
" 33	CATCHMENT 1600"				
"	1 Triangular SCS"				
"	1 Equal length"				
"	1 SCS method"				
"	1600 Catchment 1600"				
"	50.000 % Impervious"				
"	0.360 Total Area"				
"	15.000 Flow length"				
"	2.000 Overland Slope"				
"	0.180 Pervious Area"				
"	15.000 Pervious length"				
"	2.000 Pervious slope"				
"	0.180 Impervious Area"				
"	15.000 Impervious length"				
"	2.000 Impervious slope"				

```

Post__REG
" 0.250 Pervious Manning 'n'"
" 78.000 Pervious SCS Curve No."
" 0.739 Pervious Runoff coefficient"
" 0.100 Pervious Ia/S coefficient"
" 7.164 Pervious Initial abstraction"
" 0.015 Impervious Manning 'n'"
" 98.000 Impervious SCS Curve No."
" 0.844 Impervious Runoff coefficient"
" 0.100 Impervious Ia/S coefficient"
" 0.518 Impervious Initial abstraction"
" 0.044 0.129 0.000 0.000 c.m/sec"
" Catchment 1600 Pervious Impervious Total Area "
" Surface Area 0.180 0.180 0.360 hectare"
" Time of concentration 10.506 1.887 5.911 minutes"
" Time to Centroid 2500.832 2301.045 2394.332 minutes"
" Rainfall depth 285.000 285.000 285.000 mm"
" Rainfall volume 513.00 513.00 1026.00 c.m"
" Rainfall losses 74.380 44.546 59.463 mm"
" Runoff depth 210.620 240.454 225.537 mm"
" Runoff volume 379.12 432.82 811.93 c.m"
" Runoff coefficient 0.739 0.844 0.791 "
" Maximum flow 0.021 0.023 0.044 c.m/sec"
40 HYDROGRAPH Add Runoff "
" 4 Add Runoff "
" 0.044 0.173 0.000 0.000"
54 POND DESIGN"
" 0.173 Current peak flow c.m/sec"
" 0.250 Target outflow c.m/sec"
" 3217.6 Hydrograph volume c.m"
" 16. Number of stages"
" 411.830 Minimum water level metre"
" 414.490 Maximum water level metre"
" 411.830 Starting water level metre"
" 0 Keep Design Data: 1 = True; 0 = False"
" Level Discharge Volume"
" 411.830 0.00033 0.000"
" 411.930 0.00033 19.920"
" 412.230 0.00034 143.570"
" 412.530 0.00035 267.220"
" 412.630 0.00035 287.130"
" 412.700 0.00035 301.070"
" 412.800 0.00035 301.140"
" 413.000 0.00035 301.260"
" 413.230 0.00035 301.400"
" 413.430 0.04510 301.740"
" 413.630 0.1310 302.400"
" 413.830 0.2461 303.400"
" 414.030 0.3862 304.740"
" 414.090 0.4327 305.240"
" 414.290 0.6461 307.240"
" 414.490 0.9189 309.570"
" Peak outflow 0.173 c.m/sec"
" Maximum level 413.703 metre"
" Maximum storage 302.764 c.m"
" Centroidal lag 55.069 hours"
" 0.044 0.173 0.173 0.000 c.m/sec"
40 HYDROGRAPH Combine 1"
" 6 Combine "
" 1 Node #"
" Outlets to SWMF No. 1"
" Maximum flow 0.173 c.m/sec"
" Hydrograph volume 3104.678 c.m"
" 0.044 0.173 0.173 0.173"

```

```

Post__REG
" 40 HYDROGRAPH Start - New Tributary"
" 2 Start - New Tributary"
" 0.044 0.000 0.173 0.173"
" 33 CATCHMENT 1400"
" 1 Triangular SCS"
" 1 Equal length"
" 1 SCS method"
" 1400 Catchment 1400"
" 20.000 % Impervious"
" 0.620 Total Area"
" 30.000 Flow length"
" 2.000 Overland Slope"
" 0.496 Pervious Area"
" 30.000 Pervious length"
" 2.000 Pervious slope"
" 0.124 Impervious Area"
" 30.000 Impervious length"
" 2.000 Impervious slope"
" 0.250 Pervious Manning 'n'"
" 78.000 Pervious SCS Curve No."
" 0.764 Pervious Runoff coefficient"
" 0.100 Pervious Ia/S coefficient"
" 7.164 Pervious Initial abstraction"
" 0.015 Impervious Manning 'n'"
" 98.000 Impervious SCS Curve No."
" 0.849 Impervious Runoff coefficient"
" 0.100 Impervious Ia/S coefficient"
" 0.518 Impervious Initial abstraction"
" 0.071 0.000 0.173 0.173 c.m/sec"
" Catchment 1400 Pervious Impervious Total Area "
" Surface Area 0.496 0.124 0.620 hectare"
" Time of concentration 15.924 2.860 13.084 minutes"
" Time to Centroid 2515.051 2276.456 2463.191 minutes"
" Rainfall depth 285.000 285.000 285.000 mm"
" Rainfall volume 1413.60 353.40 1767.00 c.m"
" Rainfall losses 67.258 43.116 62.430 mm"
" Runoff depth 217.742 241.884 222.570 mm"
" Runoff volume 1080.00 299.94 1379.93 c.m"
" Runoff coefficient 0.764 0.849 0.781 "
" Maximum flow 0.055 0.016 0.071 c.m/sec"
" 40 HYDROGRAPH Add Runoff "
" 4 Add Runoff "
" 0.071 0.071 0.173 0.173"
" 54 POND DESIGN"
" 0.071 Current peak flow c.m/sec"
" 0.250 Target outflow c.m/sec"
" 1379.9 Hydrograph volume c.m"
" 17. Number of stages"
" 413.920 Minimum water level metre"
" 415.520 Maximum water level metre"
" 413.920 Starting water level metre"
" 0 Keep Design Data: 1 = True; 0 = False"
" Level Discharge Volume"
" 413.920 0.00089 0.000"
" 414.020 0.00089 26.670"
" 414.120 0.00090 54.610"
" 414.220 0.00090 82.540"
" 414.320 0.00090 110.480"
" 414.420 0.00091 138.420"
" 414.520 0.00091 165.090"
" 414.620 0.00091 191.760"
" 414.720 0.00091 191.830"
" 414.820 0.02640 191.900"

```

			Post__REG		
"	414.920	0.03734	191.970"		
"	415.020	0.04573	192.040"		
"	415.120	0.05281	192.120"		
"	415.220	0.2777	201.400"		
"	415.320	0.6941	238.900"		
"	415.420	1.244	304.650"		
"	415.520	1.909	382.150"		
"	Peak outflow		0.070	c.m/sec"	
"	Maximum level		415.128	metre"	
"	Maximum storage		192.847	c.m"	
"	Centroidal lag		48.357	hours"	
"	0.071	0.071	0.070	0.173	c.m/sec"
40	HYDROGRAPH Next link "				
"	5 Next link "				
"	0.071	0.070	0.070	0.173"	
33	CATCHMENT 1500"				
"	1 Triangular SCS"				
"	1 Equal length"				
"	1 SCS method"				
"	1500 Catchment 1500"				
"	50.000 % Impervious"				
"	1.110 Total Area"				
"	40.000 Flow length"				
"	2.000 Overland Slope"				
"	0.555 Pervious Area"				
"	40.000 Pervious length"				
"	2.000 Pervious slope"				
"	0.555 Impervious Area"				
"	40.000 Impervious length"				
"	2.000 Impervious slope"				
"	0.250 Pervious Manning 'n'"				
"	78.000 Pervious SCS Curve No."				
"	0.765 Pervious Runoff coefficient"				
"	0.100 Pervious Ia/S coefficient"				
"	7.164 Pervious Initial abstraction"				
"	0.015 Impervious Manning 'n'"				
"	98.000 Impervious SCS Curve No."				
"	0.850 Impervious Runoff coefficient"				
"	0.100 Impervious Ia/S coefficient"				
"	0.518 Impervious Initial abstraction"				
"	0.129	0.070	0.070	0.173	c.m/sec"
"	Catchment 1500	Pervious	Impervious	Total Area	"
"	Surface Area	0.555	0.555	1.110	hectare"
"	Time of concentration	18.924	3.399	10.752	minutes"
"	Time to Centroid	2520.774	2266.333	2386.847	minutes"
"	Rainfall depth	285.000	285.000	285.000	mm"
"	Rainfall volume	1581.75	1581.75	3163.50	c.m"
"	Rainfall losses	66.918	42.646	54.782	mm"
"	Runoff depth	218.082	242.354	230.218	mm"
"	Runoff volume	1210.36	1345.07	2555.42	c.m"
"	Runoff coefficient	0.765	0.850	0.808	"
"	Maximum flow	0.060	0.070	0.129	c.m/sec"
40	HYDROGRAPH Add Runoff "				
"	4 Add Runoff "				
"	0.129	0.199	0.070	0.173"	
56	DIVERSION"				
"	1500 Node number"				
"	0.146 Overflow threshold"				
"	1.000 Required diverted fraction"				
"	0 Conduit type; 1=Pipe;2=Channel"				
"	Peak of diverted flow		0.053	c.m/sec"	
"	Volume of diverted flow		288.514	c.m"	
"	DIV01500.000hyd"				

			Post__REG		
"	Major flow at 1500"				
"	0.129	0.199	0.146	0.173	c.m/sec"
" 40	HYDROGRAPH Next link "				
"	5 Next link "				
"	0.129	0.146	0.146	0.173"	
" 33	CATCHMENT 1000"				
"	1 Triangular SCS"				
"	1 Equal length"				
"	1 SCS method"				
"	1000 Catchment 1000"				
"	50.000 % Impervious"				
"	6.760 Total Area"				
"	100.000 Flow length"				
"	2.000 Overland Slope"				
"	3.380 Pervious Area"				
"	100.000 Pervious length"				
"	2.000 Pervious slope"				
"	3.380 Impervious Area"				
"	100.000 Impervious length"				
"	2.000 Impervious slope"				
"	0.250 Pervious Manning 'n'"				
"	78.000 Pervious SCS Curve No."				
"	0.764 Pervious Runoff coefficient"				
"	0.100 Pervious Ia/S coefficient"				
"	7.164 Pervious Initial abstraction"				
"	0.015 Impervious Manning 'n'"				
"	98.000 Impervious SCS Curve No."				
"	0.884 Impervious Runoff coefficient"				
"	0.100 Impervious Ia/S coefficient"				
"	0.518 Impervious Initial abstraction"				
"	0.744	0.146	0.146	0.173	c.m/sec"
"	Catchment 1000	Pervious	Impervious	Total Area	"
"	Surface Area	3.380	3.380	6.760	hectare"
"	Time of concentration	32.793	5.891	18.359	minutes"
"	Time to Centroid	2537.301	2260.661	2388.880	minutes"
"	Rainfall depth	285.000	285.000	285.000	mm"
"	Rainfall volume	0.9633	0.9633	1.9266	ha-m"
"	Rainfall losses	67.335	33.040	50.188	mm"
"	Runoff depth	217.665	251.960	234.812	mm"
"	Runoff volume	0.7357	0.8516	1.5873	ha-m"
"	Runoff coefficient	0.764	0.884	0.824	"
"	Maximum flow	0.394	0.428	0.744	c.m/sec"
" 40	HYDROGRAPH Add Runoff "				
"	4 Add Runoff "				
"	0.744	0.890	0.146	0.173"	
" 33	CATCHMENT 1100"				
"	1 Triangular SCS"				
"	1 Equal length"				
"	1 SCS method"				
"	1100 Catchment 1100"				
"	0.000 % Impervious"				
"	0.480 Total Area"				
"	20.000 Flow length"				
"	2.000 Overland Slope"				
"	0.480 Pervious Area"				
"	20.000 Pervious length"				
"	2.000 Pervious slope"				
"	0.000 Impervious Area"				
"	20.000 Impervious length"				
"	2.000 Impervious slope"				
"	0.250 Pervious Manning 'n'"				
"	78.000 Pervious SCS Curve No."				
"	0.754 Pervious Runoff coefficient"				

```

Post__REG
" 0.100 Pervious Ia/S coefficient"
" 7.164 Pervious Initial abstraction"
" 0.015 Impervious Manning 'n'"
" 98.000 Impervious SCS Curve No."
" 0.000 Impervious Runoff coefficient"
" 0.100 Impervious Ia/S coefficient"
" 0.518 Impervious Initial abstraction"
" 0.055 0.890 0.146 0.173 c.m/sec"
" Catchment 1100 Pervious Impervious Total Area "
" Surface Area 0.480 0.000 0.480 hectare"
" Time of concentration 12.485 2.243 12.485 minutes"
" Time to Centroid 2505.277 2290.972 2505.276 minutes"
" Rainfall depth 285.000 285.000 285.000 mm"
" Rainfall volume 1368.00 0.00 1368.00 c.m"
" Rainfall losses 70.073 43.972 70.073 mm"
" Runoff depth 214.927 241.028 214.927 mm"
" Runoff volume 1031.65 0.00 1031.65 c.m"
" Runoff coefficient 0.754 0.000 0.754 "
" Maximum flow 0.055 0.000 0.055 c.m/sec"
40 HYDROGRAPH Add Runoff "
" 4 Add Runoff "
" 0.055 0.945 0.146 0.173"
40 HYDROGRAPH Copy to Outflow"
" 8 Copy to Outflow"
" 0.055 0.945 0.945 0.173"
40 HYDROGRAPH Combine 1"
" 6 Combine "
" 1 Node #"
" Outlets to SWMF No. 1"
" Maximum flow 1.118 c.m/sec"
" Hydrograph volume 23654.564 c.m"
" 0.055 0.945 0.945 1.118"
40 HYDROGRAPH Confluence 1"
" 7 Confluence "
" 1 Node #"
" Outlets to SWMF No. 1"
" Maximum flow 1.118 c.m/sec"
" Hydrograph volume 23654.564 c.m"
" 0.055 1.118 0.945 0.000"
54 POND DESIGN"
" 1.118 Current peak flow c.m/sec"
" 0.250 Target outflow c.m/sec"
" 23654.6 Hydrograph volume c.m"
" 11. Number of stages"
" 411.000 Minimum water level metre"
" 412.000 Maximum water level metre"
" 411.000 Starting water level metre"
" 0 Keep Design Data: 1 = True; 0 = False"
" Level Discharge Volume"
" 411.000 0.000 0.000"
" 411.100 0.05100 425.000"
" 411.200 0.1030 936.000"
" 411.300 0.1190 1459.000"
" 411.400 0.1330 1994.000"
" 411.500 0.3220 2542.000"
" 411.600 0.3510 3101.000"
" 411.700 0.3780 3673.000"
" 411.800 0.4030 4258.000"
" 411.850 0.4150 4554.000"
" 412.000 2.088 5464.000"
" Peak outflow 1.028 c.m/sec"
" Maximum level 411.908 metre"
" Maximum storage 4908.128 c.m"

```

```

"          Post__REG
"          Centroidal lag          43.521  hours"
"          0.055  1.118  1.028  0.000 c.m/sec"
" 40 HYDROGRAPH Next link "
"      5 Next link "
"          0.055  1.028  1.028  0.000"
" 47 FILEI_O Read/Open DIV01500.000hyd"
"      1 1=read/open; 2=write/save"
"      2 1=rainfall; 2=hydrograph"
"      1 1=runoff; 2=inflow; 3=outflow; 4=junction"
"      DIV01500.000hyd"
"      Major flow at 1500"
"      Total volume          288.514  c.m"
"      Maximum flow          0.053  c.m/sec"
"          0.053  1.028  1.028  0.000 c.m/sec"
" 40 HYDROGRAPH Add Runoff "
"      4 Add Runoff "
"          0.053  1.055  1.028  0.000"
" 33 CATCHMENT 4000"
"      1 Triangular SCS"
"      1 Equal length"
"      1 SCS method"
"      4000 Catchment 4000"
"      0.000 % Impervious"
"      7.330 Total Area"
"      60.000 Flow length"
"      2.000 Overland Slope"
"      7.330 Pervious Area"
"      60.000 Pervious length"
"      2.000 Pervious slope"
"      0.000 Impervious Area"
"      60.000 Impervious length"
"      2.000 Impervious slope"
"      0.250 Pervious Manning 'n'"
"      50.000 Pervious SCS Curve No."
"      0.453 Pervious Runoff coefficient"
"      0.100 Pervious Ia/S coefficient"
"      25.400 Pervious Initial abstraction"
"      0.015 Impervious Manning 'n'"
"      98.000 Impervious SCS Curve No."
"      0.000 Impervious Runoff coefficient"
"      0.100 Impervious Ia/S coefficient"
"      0.518 Impervious Initial abstraction"
"          0.619  1.055  1.028  0.000 c.m/sec"
"      Catchment 4000 Pervious Impervious Total Area "
"      Surface Area          7.330  0.000  7.330  hectare"
"      Time of concentration  27.692  4.336  27.692  minutes"
"      Time to Centroid      2672.198  2258.968  2672.197  minutes"
"      Rainfall depth        285.000  285.000  285.000  mm"
"      Rainfall volume       2.0890  0.0000  2.0891  ha-m"
"      Rainfall losses       155.800  39.404  155.800  mm"
"      Runoff depth          129.200  245.596  129.200  mm"
"      Runoff volume         9470.35  0.02  9470.37  c.m"
"      Runoff coefficient     0.453  0.000  0.453  "
"      Maximum flow          0.619  0.000  0.619  c.m/sec"
" 40 HYDROGRAPH Add Runoff "
"      4 Add Runoff "
"          0.619  1.674  1.028  0.000"
" 54 POND DESIGN"
"      1.674 Current peak flow  c.m/sec"
"      0.250 Target outflow  c.m/sec"
"      32588.7 Hydrograph volume  c.m"
"      6. Number of stages"
"      409.630 Minimum water level  metre"

```

```

Post__REG
" 410.750 Maximum water level metre"
" 409.630 Starting water level metre"
" 0 Keep Design Data: 1 = True; 0 = False"
" Level Discharge Volume"
" 409.630 0.000 0.000"
" 409.750 0.6650 402.200"
" 410.000 3.601 2187.900"
" 410.250 7.811 5318.900"
" 410.500 12.984 9642.300"
" 410.750 18.965 15227.70"
" Peak outflow 1.555 c.m/sec"
" Maximum level 409.826 metre"
" Maximum storage 943.398 c.m"
" Centroidal lag 44.008 hours"
" 0.619 1.674 1.555 0.000 c.m/sec"
40 HYDROGRAPH Next link "
5 Next link "
" 0.619 1.555 1.555 0.000"
52 CHANNEL DESIGN"
1.555 Current peak flow c.m/sec"
0.035 Manning 'n'"
0 Cross-section type: 0=trapezoidal; 1=general"
0.000 Basewidth metre"
7.410 Left bank slope"
6.000 Right bank slope"
0.950 Channel depth metre"
1.040 Gradient %"
" Depth of flow 0.462 metre"
" Velocity 1.088 m/sec"
" Channel capacity 10.655 c.m/sec"
" Critical depth 0.406 metre"
53 ROUTE Channel Route 72"
72.40 Channel Route 72 Reach length (metre)"
0.385 X-factor <= 0.5"
49.895 K-lag (seconds)"
0.000 Default(0) or user spec.(1) values used"
0.500 X-factor <= 0.5"
30.000 K-lag (seconds)"
0.500 Beta weighting factor"
61.017 Routing time step (seconds)"
1 No. of sub-reaches"
" Peak outflow 1.546 c.m/sec"
" 0.619 1.555 1.546 0.000 c.m/sec"
40 HYDROGRAPH Next link "
5 Next link "
" 0.619 1.546 1.546 0.000"
52 CHANNEL DESIGN"
1.546 Current peak flow c.m/sec"
0.035 Manning 'n'"
0 Cross-section type: 0=trapezoidal; 1=general"
2.000 Basewidth metre"
2.950 Left bank slope"
3.000 Right bank slope"
0.950 Channel depth metre"
1.040 Gradient %"
" Depth of flow 0.393 metre"
" Velocity 1.243 m/sec"
" Channel capacity 9.246 c.m/sec"
" Critical depth 0.331 metre"
53 ROUTE Channel Route 40"
39.80 Channel Route 40 Reach length (metre)"
0.252 X-factor <= 0.5"
24.016 K-lag (seconds)"

```



```

                                Post__REG
"      0.000 Default(0) or user spec.(1) values used"
"      0.500 X-factor <= 0.5"
"     30.000 K-lag ( seconds)"
"      0.500 Beta weighting factor"
"    35.644 Routing time step ( seconds)"
"      1 No. of sub-reaches"
"      Peak outflow                1.541 c.m/sec"
"      0.619 1.546 1.541 0.000 c.m/sec"
" 40 HYDROGRAPH Combine 100"
"      6 Combine "
"     100 Node #"
"      Existing wetland"
"      Maximum flow                1.541 c.m/sec"
"      Hydrograph volume          32587.465 c.m"
"      0.619 1.546 1.541 1.541"
" 40 HYDROGRAPH Start - New Tributary"
"      2 Start - New Tributary"
"      0.619 0.000 1.541 1.541"
" 33 CATCHMENT 2100"
"      1 Triangular SCS"
"      1 Equal length"
"      1 SCS method"
"     2100 Catchment 2100"
"     60.000 % Impervious"
"     1.960 Total Area"
"     40.000 Flow length"
"     2.000 Overland Slope"
"     0.784 Pervious Area"
"     40.000 Pervious length"
"     2.000 Pervious slope"
"     1.176 Impervious Area"
"     40.000 Impervious length"
"     2.000 Impervious slope"
"     0.250 Pervious Manning 'n'"
"     78.000 Pervious SCS Curve No."
"     0.765 Pervious Runoff coefficient"
"     0.100 Pervious Ia/S coefficient"
"     7.164 Pervious Initial abstraction"
"     0.015 Impervious Manning 'n'"
"    98.000 Impervious SCS Curve No."
"     0.850 Impervious Runoff coefficient"
"     0.100 Impervious Ia/S coefficient"
"     0.518 Impervious Initial abstraction"
"      0.232 0.000 1.541 1.541 c.m/sec"
"      Catchment 2100 Pervious Impervious Total Area "
"      Surface Area          0.784 1.176 1.960 hectare"
"      Time of concentration 18.924 3.399 9.220 minutes"
"      Time to Centroid      2520.773 2266.333 2361.739 minutes"
"      Rainfall depth        285.000 285.000 285.000 mm"
"      Rainfall volume       2234.40 3351.60 5586.00 c.m"
"      Rainfall losses       66.918 42.646 52.354 mm"
"      Runoff depth          218.082 242.354 232.646 mm"
"      Runoff volume         1709.77 2850.09 4559.85 c.m"
"      Runoff coefficient    0.765 0.850 0.816 "
"      Maximum flow         0.085 0.148 0.232 c.m/sec"
" 40 HYDROGRAPH Add Runoff "
"      4 Add Runoff "
"      0.232 0.232 1.541 1.541"
" 33 CATCHMENT 2400"
"      1 Triangular SCS"
"      1 Equal length"
"      1 SCS method"
"     2400 Catchment 2400"

```

```

"      90.000  % Impervious"
"      0.790  Total Area"
"      20.000  Flow length"
"      2.000  Overland Slope"
"      0.079  Pervious Area"
"      20.000  Pervious length"
"      2.000  Pervious slope"
"      0.711  Impervious Area"
"      20.000  Impervious length"
"      2.000  Impervious slope"
"      0.250  Pervious Manning 'n'"
"      78.000  Pervious SCS Curve No."
"      0.754  Pervious Runoff coefficient"
"      0.100  Pervious Ia/S coefficient"
"      7.164  Pervious Initial abstraction"
"      0.015  Impervious Manning 'n'"
"      98.000  Impervious SCS Curve No."
"      0.846  Impervious Runoff coefficient"
"      0.100  Impervious Ia/S coefficient"
"      0.518  Impervious Initial abstraction"
"          0.100  0.232  1.541  1.541 c.m/sec"
"      Catchment 2400  Pervious  Impervious  Total Area  "
"      Surface Area  0.079  0.711  0.790  hectare"
"      Time of concentration  12.485  2.243  3.166  minutes"
"      Time to Centroid  2505.277  2290.972  2310.291  minutes"
"      Rainfall depth  285.000  285.000  285.000  mm"
"      Rainfall volume  225.15  2026.35  2251.50  c.m"
"      Rainfall losses  70.073  43.972  46.582  mm"
"      Runoff depth  214.927  241.028  238.418  mm"
"      Runoff volume  169.79  1713.71  1883.50  c.m"
"      Runoff coefficient  0.754  0.846  0.837  "
"      Maximum flow  0.009  0.091  0.100  c.m/sec"
" 40  HYDROGRAPH Add Runoff "
"      4  Add Runoff "
"          0.100  0.332  1.541  1.541"
" 54  POND DESIGN"
"      0.332  Current peak flow  c.m/sec"
"      0.756  Target outflow  c.m/sec"
"      6443.4  Hydrograph volume  c.m"
"      13.  Number of stages"
"      410.650  Minimum water level  metre"
"      411.950  Maximum water level  metre"
"      410.650  Starting water level  metre"
"      0  Keep Design Data: 1 = True; 0 = False"
"          Level Discharge  Volume"
"      410.650  0.000  0.000"
"      410.700  0.00600  42.000"
"      410.800  0.01300  130.000"
"      410.900  0.02000  225.000"
"      411.000  0.02500  328.000"
"      411.100  0.02900  439.000"
"      411.200  0.1260  558.000"
"      411.300  0.1390  686.000"
"      411.400  0.1510  822.000"
"      411.500  0.1630  967.000"
"      411.600  0.1730  1121.000"
"      411.650  0.1780  1202.000"
"      411.950  2.575  1742.000"
"      Peak outflow  0.268  c.m/sec"
"      Maximum level  411.661  metre"
"      Maximum storage  1222.588  c.m"
"      Centroidal lag  41.113  hours"
"          0.100  0.332  0.268  1.541 c.m/sec"

```

```

" 40          HYDROGRAPH Next link "      Post__REG
"          5  Next link "
"              0.100      0.268      0.268      1.541"
" 33  CATCHMENT 2300"
"      1  Triangular SCS"
"      1  Equal length"
"      1  SCS method"
"      2300 Catchment 2300"
"      10.000 % Impervious"
"      0.480 Total Area"
"      20.000 Flow length"
"      2.000 Overland Slope"
"      0.432 Pervious Area"
"      20.000 Pervious length"
"      2.000 Pervious slope"
"      0.048 Impervious Area"
"      20.000 Impervious length"
"      2.000 Impervious slope"
"      0.250 Pervious Manning 'n'"
"      78.000 Pervious SCS Curve No."
"      0.754 Pervious Runoff coefficient"
"      0.100 Pervious Ia/S coefficient"
"      7.164 Pervious Initial abstraction"
"      0.015 Impervious Manning 'n'"
"      98.000 Impervious SCS Curve No."
"      0.846 Impervious Runoff coefficient"
"      0.100 Impervious Ia/S coefficient"
"      0.518 Impervious Initial abstraction"
"              0.055      0.268      0.268      1.541 c.m/sec"
"      Catchment 2300      Pervious      Impervious Total Area "
"      Surface Area      0.432      0.048      0.480      hectare"
"      Time of concentration      12.485      2.243      11.350      minutes"
"      Time to Centroid      2505.277      2290.972      2481.532      minutes"
"      Rainfall depth      285.000      285.000      285.000      mm"
"      Rainfall volume      1231.20      136.80      1368.00      c.m"
"      Rainfall losses      70.073      43.972      67.463      mm"
"      Runoff depth      214.927      241.028      217.537      mm"
"      Runoff volume      928.48      115.69      1044.18      c.m"
"      Runoff coefficient      0.754      0.846      0.763      "
"      Maximum flow      0.049      0.006      0.055      c.m/sec"
" 40  HYDROGRAPH Add Runoff "
"      4  Add Runoff "
"              0.055      0.315      0.268      1.541"
" 40  HYDROGRAPH Copy to Outflow"
"      8  Copy to Outflow"
"              0.055      0.315      0.315      1.541"
" 40  HYDROGRAPH Combine 200"
"      6  Combine "
"      200 Node #"
"      To Trib. of Grand River"
"      Maximum flow      0.315      c.m/sec"
"      Hydrograph volume      7579.884      c.m"
"              0.055      0.315      0.315      0.315"
" 40  HYDROGRAPH Start - New Tributary"
"      2  Start - New Tributary"
"              0.055      0.000      0.315      0.315"
" 33  CATCHMENT 2200"
"      1  Triangular SCS"
"      1  Equal length"
"      1  SCS method"
"      2200 Catchment 2200"
"      75.000 % Impervious"
"      0.920 Total Area"

```

```

Post__REG
" 40.000 Flow length"
" 2.000 Overland Slope"
" 0.230 Pervious Area"
" 40.000 Pervious length"
" 2.000 Pervious slope"
" 0.690 Impervious Area"
" 40.000 Impervious length"
" 2.000 Impervious slope"
" 0.250 Pervious Manning 'n'"
" 78.000 Pervious SCS Curve No."
" 0.765 Pervious Runoff coefficient"
" 0.100 Pervious Ia/S coefficient"
" 7.164 Pervious Initial abstraction"
" 0.015 Impervious Manning 'n'"
" 98.000 Impervious SCS Curve No."
" 0.850 Impervious Runoff coefficient"
" 0.100 Impervious Ia/S coefficient"
" 0.518 Impervious Initial abstraction"
" 0.112 0.000 0.315 0.315 c.m/sec"
" Catchment 2200 Pervious Impervious Total Area "
" Surface Area 0.230 0.690 0.920 hectare"
" Time of concentration 18.924 3.399 6.981 minutes"
" Time to Centroid 2520.774 2266.333 2325.042 minutes"
" Rainfall depth 285.000 285.000 285.000 mm"
" Rainfall volume 655.50 1966.50 2622.00 c.m"
" Rainfall losses 66.918 42.646 48.714 mm"
" Runoff depth 218.082 242.354 236.286 mm"
" Runoff volume 501.59 1672.25 2173.83 c.m"
" Runoff coefficient 0.765 0.850 0.829 "
" Maximum flow 0.025 0.087 0.112 c.m/sec"
" 40 HYDROGRAPH Add Runoff "
" 4 Add Runoff "
" 0.112 0.112 0.315 0.315"
" 54 POND DESIGN"
" 0.112 Current peak flow c.m/sec"
" 0.756 Target outflow c.m/sec"
" 2173.8 Hydrograph volume c.m"
" 12. Number of stages"
" 413.700 Minimum water level metre"
" 415.000 Maximum water level metre"
" 413.700 Starting water level metre"
" 0 Keep Design Data: 1 = True; 0 = False"
" Level Discharge Volume"
" 413.700 0.000 0.000"
" 413.800 0.00500 88.600"
" 413.900 0.01000 187.200"
" 414.000 0.01300 298.400"
" 414.100 0.01500 422.200"
" 414.200 0.2220 558.900"
" 414.300 0.2590 708.500"
" 414.400 0.2910 871.100"
" 414.500 0.3210 1046.900"
" 414.600 0.3470 1236.100"
" 414.700 0.3720 1438.700"
" 415.000 2.808 2087.400"
" Peak outflow 0.096 c.m/sec"
" Maximum level 414.144 metre"
" Maximum storage 481.835 c.m"
" Centroidal lag 42.646 hours"
" 0.112 0.112 0.096 0.315 c.m/sec"
" 40 HYDROGRAPH Combine 200"
" 6 Combine "
" 200 Node #"

```

		Post__REG			
"	To Trib. of Grand River"				
"	Maximum flow	0.406		c.m/sec"	
"	Hydrograph volume	9741.546		c.m"	
"	0.112 0.112 0.096			0.406"	
40	HYDROGRAPH Start - New Tributary"				
"	2 Start - New Tributary"				
"	0.112 0.000 0.096			0.406"	
33	CATCHMENT 3200"				
"	1 Triangular SCS"				
"	1 Equal length"				
"	1 SCS method"				
"	3200 Catchment 3200"				
"	60.000 % Impervious"				
"	0.530 Total Area"				
"	20.000 Flow length"				
"	2.000 Overland Slope"				
"	0.212 Pervious Area"				
"	20.000 Pervious length"				
"	2.000 Pervious slope"				
"	0.318 Impervious Area"				
"	20.000 Impervious length"				
"	2.000 Impervious slope"				
"	0.250 Pervious Manning 'n'"				
"	78.000 Pervious SCS Curve No."				
"	0.754 Pervious Runoff coefficient"				
"	0.100 Pervious Ia/S coefficient"				
"	7.164 Pervious Initial abstraction"				
"	0.015 Impervious Manning 'n'"				
"	98.000 Impervious SCS Curve No."				
"	0.846 Impervious Runoff coefficient"				
"	0.100 Impervious Ia/S coefficient"				
"	0.518 Impervious Initial abstraction"				
"	0.065 0.000 0.096			0.406 c.m/sec"	
"	Catchment 3200 Pervious Impervious Total Area "				
"	Surface Area 0.212 0.318 0.530			hectare"	
"	Time of concentration 12.485 2.243 6.061			minutes"	
"	Time to Centroid 2505.277 2290.972 2370.872			minutes"	
"	Rainfall depth 285.000 285.000 285.000			mm"	
"	Rainfall volume 604.20 906.30 1510.50			c.m"	
"	Rainfall losses 70.073 43.972 54.413			mm"	
"	Runoff depth 214.927 241.028 230.587			mm"	
"	Runoff volume 455.64 766.47 1222.11			c.m"	
"	Runoff coefficient 0.754 0.846 0.809			"	
"	Maximum flow 0.024 0.041 0.065			c.m/sec"	
40	HYDROGRAPH Add Runoff "				
"	4 Add Runoff "				
"	0.065 0.065 0.096 0.406"				
33	CATCHMENT 3300"				
"	1 Triangular SCS"				
"	1 Equal length"				
"	1 SCS method"				
"	3300 Catchment 3300"				
"	60.000 % Impervious"				
"	0.240 Total Area"				
"	20.000 Flow length"				
"	2.000 Overland Slope"				
"	0.096 Pervious Area"				
"	20.000 Pervious length"				
"	2.000 Pervious slope"				
"	0.144 Impervious Area"				
"	20.000 Impervious length"				
"	2.000 Impervious slope"				
"	0.250 Pervious Manning 'n'"				

```

Post__REG
" 78.000 Pervious SCS Curve No."
" 0.754 Pervious Runoff coefficient"
" 0.100 Pervious Ia/S coefficient"
" 7.164 Pervious Initial abstraction"
" 0.015 Impervious Manning 'n'"
" 98.000 Impervious SCS Curve No."
" 0.846 Impervious Runoff coefficient"
" 0.100 Impervious Ia/S coefficient"
" 0.518 Impervious Initial abstraction"
" 0.029 0.065 0.096 0.406 c.m/sec"
" Catchment 3300 Pervious Impervious Total Area "
" Surface Area 0.096 0.144 0.240 hectare"
" Time of concentration 12.485 2.243 6.061 minutes"
" Time to Centroid 2505.277 2290.972 2370.872 minutes"
" Rainfall depth 285.000 285.000 285.000 mm"
" Rainfall volume 273.60 410.40 684.00 c.m"
" Rainfall losses 70.073 43.972 54.413 mm"
" Runoff depth 214.927 241.028 230.587 mm"
" Runoff volume 206.33 347.08 553.41 c.m"
" Runoff coefficient 0.754 0.846 0.809 "
" Maximum flow 0.011 0.018 0.029 c.m/sec"
" 40 HYDROGRAPH Add Runoff "
" 4 Add Runoff "
" 0.029 0.094 0.096 0.406"
" 40 HYDROGRAPH Copy to Outflow"
" 8 Copy to Outflow"
" 0.029 0.094 0.094 0.406"
" 40 HYDROGRAPH Combine 300"
" 6 Combine "
" 300 Node #"
" To Walser Street"
" Maximum flow 0.094 c.m/sec"
" Hydrograph volume 1775.523 c.m"
" 0.029 0.094 0.094 0.094"
" 40 HYDROGRAPH Confluence 300"
" 7 Confluence "
" 300 Node #"
" To Walser Street"
" Maximum flow 0.094 c.m/sec"
" Hydrograph volume 1775.523 c.m"
" 0.029 0.094 0.094 0.000"
" 40 HYDROGRAPH Copy to Outflow"
" 8 Copy to Outflow"
" 0.029 0.094 0.094 0.000"
" 40 HYDROGRAPH Combine 100"
" 6 Combine "
" 100 Node #"
" Existing wetland"
" Maximum flow 1.614 c.m/sec"
" Hydrograph volume 34362.984 c.m"
" 0.029 0.094 0.094 1.614"
" 40 HYDROGRAPH Confluence 100"
" 7 Confluence "
" 100 Node #"
" Existing wetland"
" Maximum flow 1.614 c.m/sec"
" Hydrograph volume 34362.988 c.m"
" 0.029 1.614 0.094 0.000"
" 40 HYDROGRAPH Copy to Outflow"
" 8 Copy to Outflow"
" 0.029 1.614 1.614 0.000"
" 40 HYDROGRAPH Combine 200"
" 6 Combine "

```

```

"                                     Post__REG
"
" 200 Node #"
"   To Trib. of Grand River"
"   Maximum flow                2.020    c.m/sec"
"   Hydrograph volume           44104.500 c.m"
"   0.029    1.614    1.614    2.020"
" 40 HYDROGRAPH Confluence 200"
"   7 Confluence "
" 200 Node #"
"   To Trib. of Grand River"
"   Maximum flow                2.020    c.m/sec"
"   Hydrograph volume           44104.496 c.m"
"   0.029    2.020    1.614    0.000"
" 38 START/RE-START TOTALS 200"
"   3 Runoff Totals on EXIT"
"   Total Catchment area                22.640 hectare"
"   Total Impervious area                7.856 hectare"
"   Total % impervious                 34.700"
" 19 EXIT"

```

Brief Stormceptor Sizing Report - 1000 (southerly portion)

Project Information & Location			
Project Name	Ainley Farm	Project Number	411009
City		State/ Province	Ontario
Country	Canada	Date	2/12/2019
Designer Information		EOR Information (optional)	
Name	Patricia Wiebe	Name	
Company	GM BluePlan Engineering Ltd.	Company	
Phone #	519-748-1440	Phone #	
Email	patricia.wiebe@gmblueplan.ca	Email	

Stormwater Treatment Recommendation

The recommended Stormceptor Model(s) which achieve or exceed the user defined water quality objective for each site within the project are listed in the below Sizing Summary table.

Site Name	1000 (southerly portion)
Target TSS Removal (%)	80
TSS Removal (%) Provided	
Recommended Stormceptor Model	STC 3000

The recommended Stormceptor Model achieves the water quality objectives based on the selected inputs, historical rainfall records and selected particle size distribution.

Stormceptor Sizing Summary		
Stormceptor Model	% TSS Removal Provided	% Runoff Volume Captured Provided
STC 300	62	75
STC 750	73	87
STC 1000	74	87
STC 1500	75	87
STC 2000	78	92
STC 3000	80	92
STC 4000	84	96
STC 5000	85	96
STC 6000	87	98
STC 9000	90	99
STC 10000	90	99
STC 14000	92	99
StormceptorMAX	Custom	Custom

Sizing Details			
Drainage Area		Water Quality Objective	
Total Area (ha)	1.69	TSS Removal (%)	80.0
Imperviousness %	50.0	Runoff Volume Capture (%)	90.00
Rainfall		Oil Spill Capture Volume (L)	
Station Name	TORONTO CENTRAL	Peak Conveyed Flow Rate (L/s)	
State/Province	Ontario	Water Quality Flow Rate (L/s)	
Station ID #	0100	Up Stream Storage	
Years of Records	18	Storage (ha-m)	Discharge (cms)
Latitude	43°37'N	0.000	0.000
Longitude	79°23'W	Up Stream Flow Diversion	
		Max. Flow to Stormceptor (cms)	

Particle Size Distribution (PSD) The selected PSD defines TSS removal		
Fine Distribution		
Particle Diameter (microns)	Distribution %	Specific Gravity
20.0	20.0	1.30
60.0	20.0	1.80
150.0	20.0	2.20
400.0	20.0	2.65
2000.0	20.0	2.65

Notes
<ul style="list-style-type: none"> Stormceptor performance estimates are based on simulations using PCSWMM for Stormceptor, which uses the EPA Rainfall and Runoff modules. Design estimates listed are only representative of specific project requirements based on total suspended solids (TSS) removal defined by the selected PSD, and based on stable site conditions only, after construction is completed. For submerged applications or sites specific to spill control, please contact your local Stormceptor representative for further design assistance.

For Stormceptor Specifications and Drawings Please Visit:
<http://www.imbriumsystems.com/technical-specifications>

Brief Stormceptor Sizing Report - 1100, 1000 (easterly portion)

Project Information & Location			
Project Name	Ainley Farm	Project Number	411009
City		State/ Province	Ontario
Country	Canada	Date	2/12/2019
Designer Information		EOR Information (optional)	
Name	Patricia Wiebe	Name	
Company	GM BluePlan Engineering Ltd.	Company	
Phone #	519-748-1440	Phone #	
Email	patricia.wiebe@gmblueplan.ca	Email	

Stormwater Treatment Recommendation

The recommended Stormceptor Model(s) which achieve or exceed the user defined water quality objective for each site within the project are listed in the below Sizing Summary table.

Site Name	1100, 1000 (easterly portion)
Target TSS Removal (%)	80
TSS Removal (%) Provided	
Recommended Stormceptor Model	STC 4000

The recommended Stormceptor Model achieves the water quality objectives based on the selected inputs, historical rainfall records and selected particle size distribution.

Stormceptor Sizing Summary		
Stormceptor Model	% TSS Removal Provided	% Runoff Volume Captured Provided
STC 300	58	70
STC 750	70	84
STC 1000	71	84
STC 1500	72	84
STC 2000	76	90
STC 3000	77	90
STC 4000	81	94
STC 5000	82	94
STC 6000	85	96
STC 9000	88	98
STC 10000	88	98
STC 14000	91	99
StormceptorMAX	Custom	Custom

Sizing Details			
Drainage Area		Water Quality Objective	
Total Area (ha)	2.18	TSS Removal (%)	80.0
Imperviousness %	50.0	Runoff Volume Capture (%)	90.00
Rainfall		Oil Spill Capture Volume (L)	
Station Name	TORONTO CENTRAL	Peak Conveyed Flow Rate (L/s)	
State/Province	Ontario	Water Quality Flow Rate (L/s)	
Station ID #	0100	Up Stream Storage	
Years of Records	18	Storage (ha-m)	Discharge (cms)
Latitude	43°37'N	0.000	0.000
Longitude	79°23'W	Up Stream Flow Diversion	
		Max. Flow to Stormceptor (cms)	

Particle Size Distribution (PSD) The selected PSD defines TSS removal		
Fine Distribution		
Particle Diameter (microns)	Distribution %	Specific Gravity
20.0	20.0	1.30
60.0	20.0	1.80
150.0	20.0	2.20
400.0	20.0	2.65
2000.0	20.0	2.65

Notes
<ul style="list-style-type: none"> Stormceptor performance estimates are based on simulations using PCSWMM for Stormceptor, which uses the EPA Rainfall and Runoff modules. Design estimates listed are only representative of specific project requirements based on total suspended solids (TSS) removal defined by the selected PSD, and based on stable site conditions only, after construction is completed. For submerged applications or sites specific to spill control, please contact your local Stormceptor representative for further design assistance.

For Stormceptor Specifications and Drawings Please Visit:
<http://www.imbriumsystems.com/technical-specifications>

Brief Stormceptor Sizing Report - 1400, 1500, 1000 (northerly portion)

Project Information & Location			
Project Name	Ainley Farm	Project Number	411009
City		State/ Province	Ontario
Country	Canada	Date	2/12/2019
Designer Information		EOR Information (optional)	
Name	Patricia Wiebe	Name	
Company	GM BluePlan Engineering Ltd.	Company	
Phone #	519-748-1440	Phone #	
Email	patricia.wiebe@gmblueplan.ca	Email	

Stormwater Treatment Recommendation

The recommended Stormceptor Model(s) which achieve or exceed the user defined water quality objective for each site within the project are listed in the below Sizing Summary table.

Site Name	1400, 1500, 1000 (northerly portion)
Target TSS Removal (%)	80
TSS Removal (%) Provided	
Recommended Stormceptor Model	STC 6000

The recommended Stormceptor Model achieves the water quality objectives based on the selected inputs, historical rainfall records and selected particle size distribution.

Stormceptor Sizing Summary		
Stormceptor Model	% TSS Removal Provided	% Runoff Volume Captured Provided
STC 300	50	57
STC 750	63	74
STC 1000	65	74
STC 1500	65	74
STC 2000	70	84
STC 3000	71	84
STC 4000	76	90
STC 5000	77	90
STC 6000	80	93
STC 9000	84	96
STC 10000	84	96
STC 14000	87	97
StormceptorMAX	Custom	Custom

Sizing Details			
Drainage Area		Water Quality Objective	
Total Area (ha)	4	TSS Removal (%)	80.0
Imperviousness %	45.0	Runoff Volume Capture (%)	90.00
Rainfall		Oil Spill Capture Volume (L)	
Station Name	TORONTO CENTRAL	Peak Conveyed Flow Rate (L/s)	
State/Province	Ontario	Water Quality Flow Rate (L/s)	
Station ID #	0100	Up Stream Storage	
Years of Records	18	Storage (ha-m)	Discharge (cms)
Latitude	43°37'N	0.000	0.000
Longitude	79°23'W	Up Stream Flow Diversion	
		Max. Flow to Stormceptor (cms)	

Particle Size Distribution (PSD) The selected PSD defines TSS removal		
Fine Distribution		
Particle Diameter (microns)	Distribution %	Specific Gravity
20.0	20.0	1.30
60.0	20.0	1.80
150.0	20.0	2.20
400.0	20.0	2.65
2000.0	20.0	2.65

Notes
<ul style="list-style-type: none"> Stormceptor performance estimates are based on simulations using PCSWMM for Stormceptor, which uses the EPA Rainfall and Runoff modules. Design estimates listed are only representative of specific project requirements based on total suspended solids (TSS) removal defined by the selected PSD, and based on stable site conditions only, after construction is completed. For submerged applications or sites specific to spill control, please contact your local Stormceptor representative for further design assistance.

For Stormceptor Specifications and Drawings Please Visit:
<http://www.imbriumsystems.com/technical-specifications>

Brief Stormceptor Sizing Report - Catchment 2100 + 2400

Project Information & Location			
Project Name	Ainley Farm	Project Number	411009
City		State/ Province	Ontario
Country	Canada	Date	2/12/2019
Designer Information		EOR Information (optional)	
Name	Patricia Wiebe	Name	
Company	GM BluePlan Engineering Ltd.	Company	
Phone #	519-748-1440	Phone #	
Email	patricia.wiebe@gmblueplan.ca	Email	

Stormwater Treatment Recommendation

The recommended Stormceptor Model(s) which achieve or exceed the user defined water quality objective for each site within the project are listed in the below Sizing Summary table.

Site Name	Catchment 2100 + 2400
Target TSS Removal (%)	80
TSS Removal (%) Provided	81
Recommended Stormceptor Model	STC 6000

The recommended Stormceptor Model achieves the water quality objectives based on the selected inputs, historical rainfall records and selected particle size distribution.

Stormceptor Sizing Summary		
Stormceptor Model	% TSS Removal Provided	% Runoff Volume Captured Provided
STC 300	51	59
STC 750	64	76
STC 1000	66	76
STC 1500	66	76
STC 2000	71	85
STC 3000	72	85
STC 4000	77	91
STC 5000	78	91
STC 6000	81	94
STC 9000	85	96
STC 10000	85	96
STC 14000	88	98
StormceptorMAX	Custom	Custom

Sizing Details			
Drainage Area		Water Quality Objective	
Total Area (ha)	2.42	TSS Removal (%)	80.0
Imperviousness %	70.0	Runoff Volume Capture (%)	90.00
Rainfall		Oil Spill Capture Volume (L)	
Station Name	TORONTO CENTRAL	Peak Conveyed Flow Rate (L/s)	
State/Province	Ontario	Water Quality Flow Rate (L/s)	
Station ID #	0100	Up Stream Storage	
Years of Records	18	Storage (ha-m)	Discharge (cms)
Latitude	43°37'N	0.000	0.000
Longitude	79°23'W	Up Stream Flow Diversion	
		Max. Flow to Stormceptor (cms)	

Particle Size Distribution (PSD) The selected PSD defines TSS removal		
Fine Distribution		
Particle Diameter (microns)	Distribution %	Specific Gravity
20.0	20.0	1.30
60.0	20.0	1.80
150.0	20.0	2.20
400.0	20.0	2.65
2000.0	20.0	2.65

Notes
<ul style="list-style-type: none"> Stormceptor performance estimates are based on simulations using PCSWMM for Stormceptor, which uses the EPA Rainfall and Runoff modules. Design estimates listed are only representative of specific project requirements based on total suspended solids (TSS) removal defined by the selected PSD, and based on stable site conditions only, after construction is completed. For submerged applications or sites specific to spill control, please contact your local Stormceptor representative for further design assistance.

For Stormceptor Specifications and Drawings Please Visit:
<http://www.imbriumsystems.com/technical-specifications>

DRAWING NOT TO BE USED FOR CONSTRUCTION

THE STORMCEPTOR SYSTEM IS PROTECTED BY ONE OR MORE OF THE FOLLOWING PATENTS:

United States Patent No. 5,753,115 • 5,849,181 • 6,068,765 • 6,371,690 • 7,582,216 • 7,666,303 | Australia Patent No. 729,096 • 779,401 • 2008,279,378 • 2008,288,900 |

Canadian Patent No. 2,206,338 • 2,327,768 • 2,694,159 • 2,697,287 | Indonesian Patent No. 007058 | Japan Patent No. 9-11476 • 3,581,233 • 5,555,160 |

Korea Patent No. 10-1451593 • 0519212 | Malaysia Patent No. 118987 | New Zealand Patent No. 314,646 • 583,583 • 583,008 | South African Patent No. 2010,00683 • 2010,01796 |

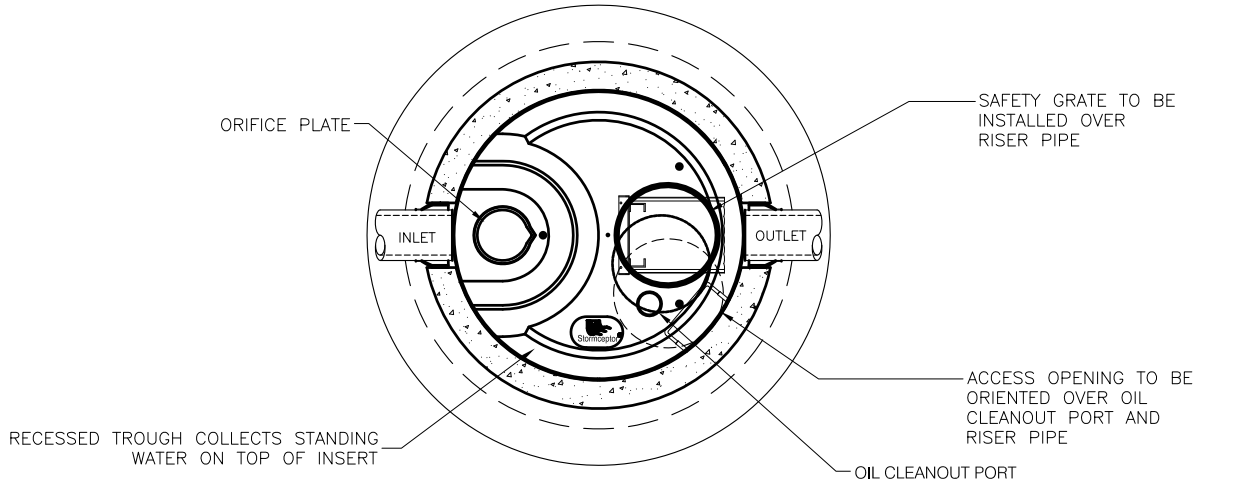

PLAN VIEW

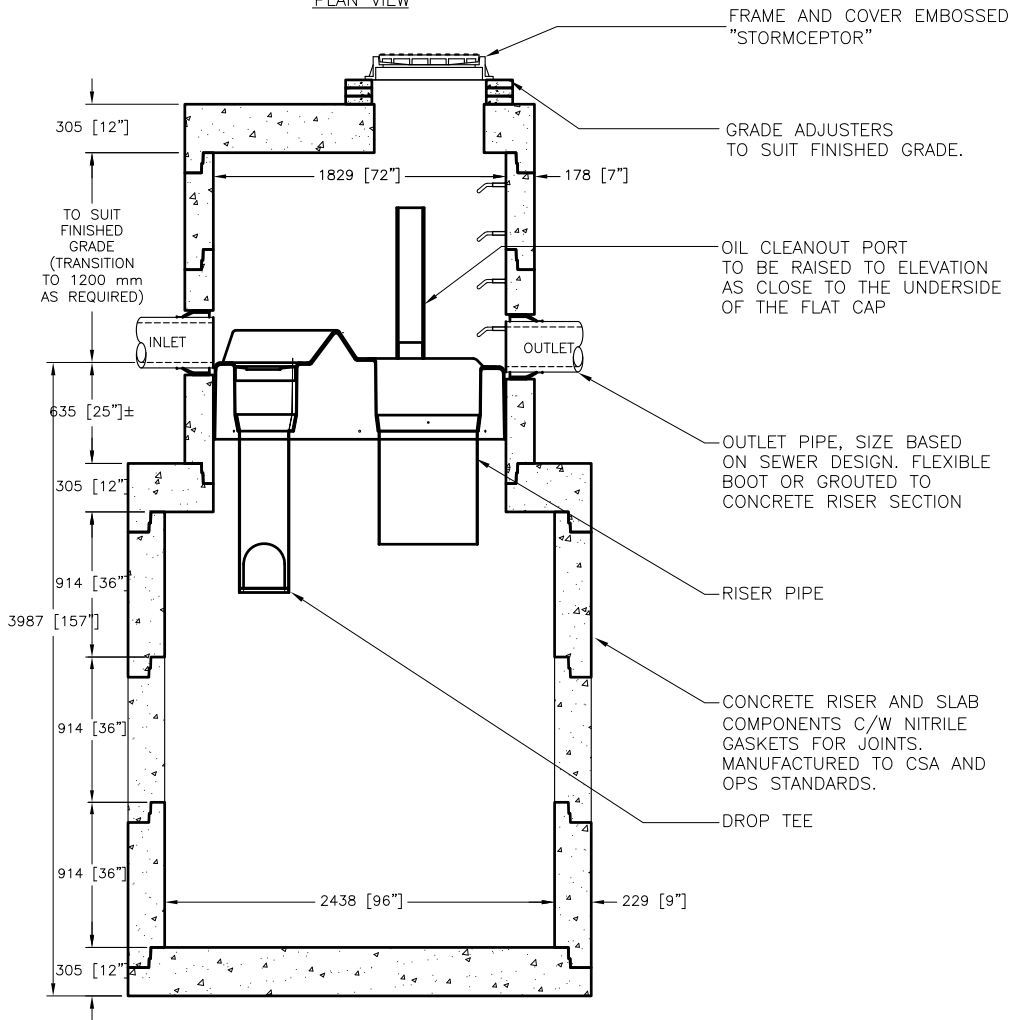

SECTION VIEW

Stormceptor

THE DESIGN AND INFORMATION SHOWN ON THIS DRAWING IS PROVIDED AS A SERVICE TO THE PROJECT OWNER, ENGINEER AND CONTRACTOR BY IMBRIUM SYSTEMS ("IMBRIUM"). NEITHER THIS DRAWING, NOR ANY PART THEREOF, MAY BE USED, REPRODUCED OR MODIFIED IN ANY MANNER WITHOUT THE PRIOR WRITTEN CONSENT OF IMBRIUM. FAILURE TO COMPLY IS DONE AT THE USER'S OWN RISK AND IMBRIUM EXPRESSLY DISCLAIMS ANY LIABILITY OR RESPONSIBILITY FOR SUCH USE. IF DISCREPANCIES BETWEEN THE SUPPLIED INFORMATION UPON WHICH THE DRAWING IS BASED AND ACTUAL FIELD CONDITIONS ARE ENCOUNTERED AS SITE WORK PROGRESSES, THESE DISCREPANCIES MUST BE REPORTED TO IMBRIUM IMMEDIATELY FOR RE-EVALUATION OF THE DESIGN. IMBRIUM ACCEPTS NO LIABILITY FOR DESIGNS BASED ON MISSING, INCOMPLETE OR INACCURATE INFORMATION SUPPLIED BY OTHERS.



7037 Ridge Road, Suite 350, Hanover, MD 21076

866-740-3318 410-796-5505 866-376-8511 FAX

STC 3000
STANDARD MODEL

####

DATE:##### SCALE: 50

REV #	DATE	REVISION DESCRIPTION	BY	SHEET NUMBER
				1
				OF 1

PROJECT No.: ##### DRAWN: ### CHECKED: ###

I:\AD\CONTECH\CPICOM\ROOT\CORPORATE\MARKETING\IMBRIUM\CAD & PDF\STORMCEPTOR\CANADIAN\STC 3000.DWG 8/8/2016 10:11 AM

DRAWING NOT TO BE USED FOR CONSTRUCTION

THE STORMCEPTOR SYSTEM IS PROTECTED BY ONE OR MORE OF THE FOLLOWING PATENTS:

United States Patent No. 5,753,115 • 5,849,181 • 6,068,765 • 6,371,690 • 7,582,216 • 7,666,303 | Australia Patent No. 729,096 • 779,401 • 2008,279,378 • 2008,288,900 |
 Canadian Patent No. 2,206,338 • 2,327,768 • 2,694,159 • 2,697,287 | European Patent No. EP 2,176,171 | Indonesian Patent No. 0,007,058 | Japan Patent No. 3,581,233 • 9-11476 • 5,555,160 |
 Korea Patent No. 10-1451593 • 0519,212 | Malaysia Patent No. 118,987 | New Zealand Patent No. 314,646 • 583,583 • 583,008 | South African Patent No. 2010,00683 • 2010,01796 |

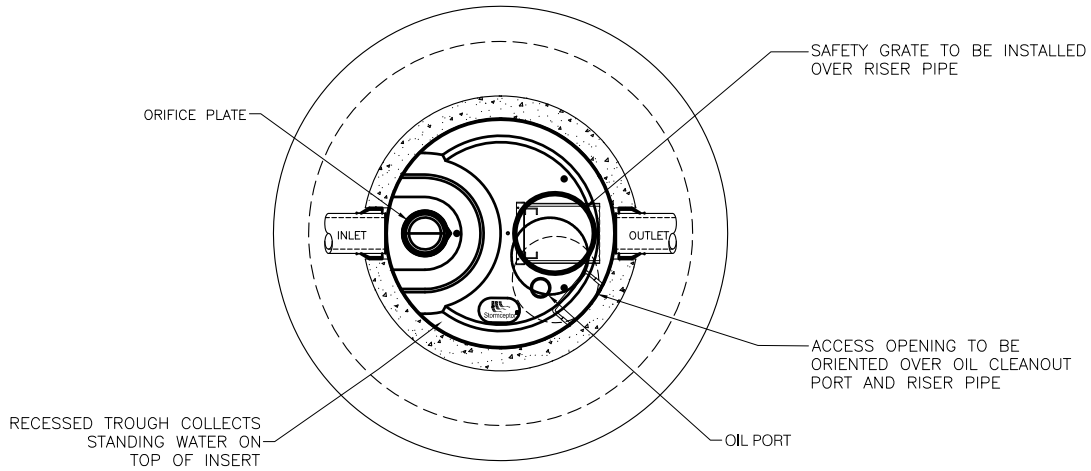

PLAN VIEW

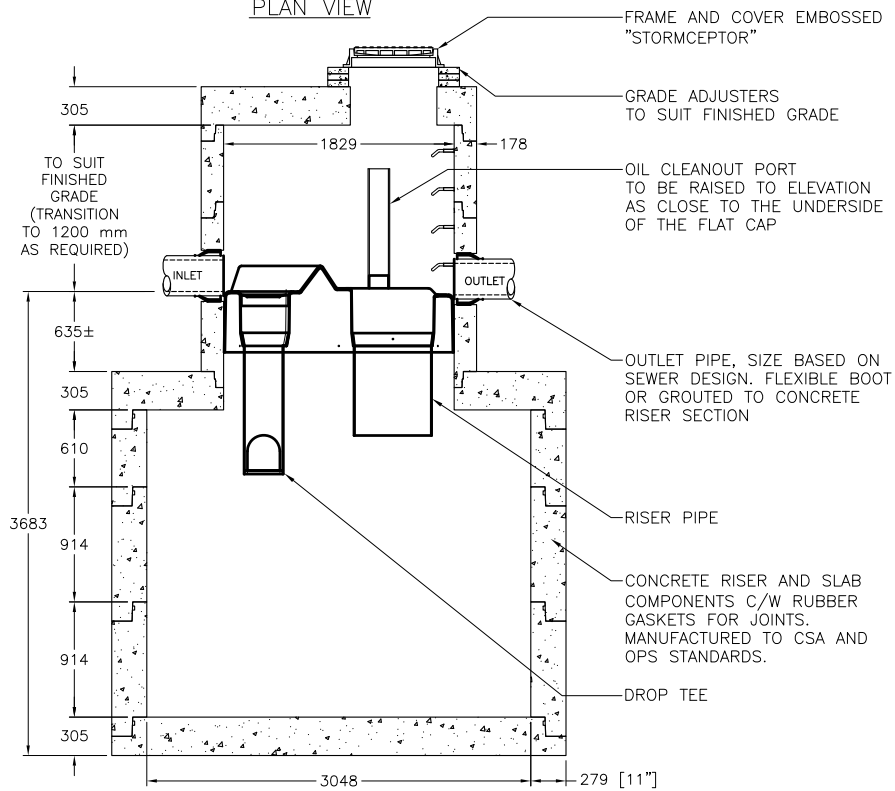

SECTION VIEW

Stormceptor

THE DESIGN AND INFORMATION SHOWN ON THIS DRAWING IS PROVIDED AS A SERVICE TO THE PROJECT OWNER, ENGINEER AND CONTRACTOR BY IMBRIUM SYSTEMS ("IMBRIUM"). NEITHER THIS DRAWING, NOR ANY PART THEREOF, MAY BE USED, REPRODUCED OR MODIFIED IN ANY MANNER WITHOUT THE PRIOR WRITTEN CONSENT OF IMBRIUM. FAILURE TO COMPLY IS DONE AT THE USER'S OWN RISK AND IMBRIUM EXPRESSLY DISCLAIMS ANY LIABILITY OR RESPONSIBILITY FOR SUCH USE. IF DISCREPANCIES BETWEEN THE SUPPLIED INFORMATION UPON WHICH THE DRAWING IS BASED AND ACTUAL FIELD CONDITIONS ARE ENCOUNTERED AS SITE WORK PROGRESSES, THESE DISCREPANCIES MUST BE REPORTED TO IMBRIUM IMMEDIATELY FOR RE-EVALUATION OF THE DESIGN. IMBRIUM ACCEPTS NO LIABILITY FOR DESIGNS BASED ON MISSING, INCOMPLETE OR INACCURATE INFORMATION SUPPLIED BY OTHERS.



605 GLOBAL WAY, SUITE 113, LINTHICUM, MD 21231

USA 888-279-8826 CA 800-565-4801 INTL +1-416-960-9900

STC 4000
STANDARD MODEL

####

DATE:##### SCALE: 50

REV #	DATE	REVISION DESCRIPTION	BY	SHEET NUMBER
				1
				OF 1

PROJECT No.: ##### DRAWN: ### CHECKED: ###

I:\AD\CONTECH-CPI\COM\ROOT\CORPORATE\MARKETING\IMBRIUM\CAD & PDF\STORMCEPTOR\CANADIAN\STC 4000.DWG 8/8/2016 9:23 AM

DRAWING NOT TO BE USED FOR CONSTRUCTION

THE STORMCEPTOR SYSTEM IS PROTECTED BY ONE OR MORE OF THE FOLLOWING PATENTS:

United States Patent No. 5,753,115 • 5,849,181 • 6,068,765 • 6,371,690 • 7,582,216 • 7,666,303 | Australia Patent No. 729,096 • 779,401 • 2008,279,378 • 2008,288,900 |

Canadian Patent No. 2,206,338 • 2,327,768 • 2,694,159 • 2,697,287 | Indonesian Patent No. 007058 | Japan Patent No. 9-11476 • 3,581,233 • 5,555,160 |

Korea Patent No. 10-1451593 • 0519212 | Malaysia Patent No. 118987 | New Zealand Patent No. 314,646 • 583,583 • 583,008 | South African Patent No. 2010,00683 • 2010,01796 |

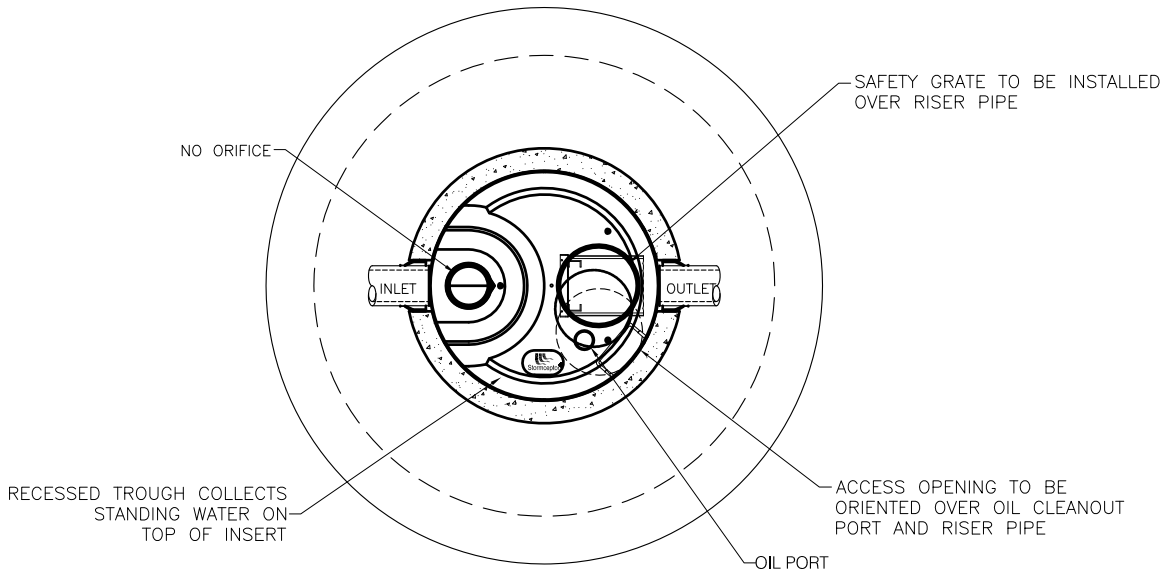

PLAN VIEW

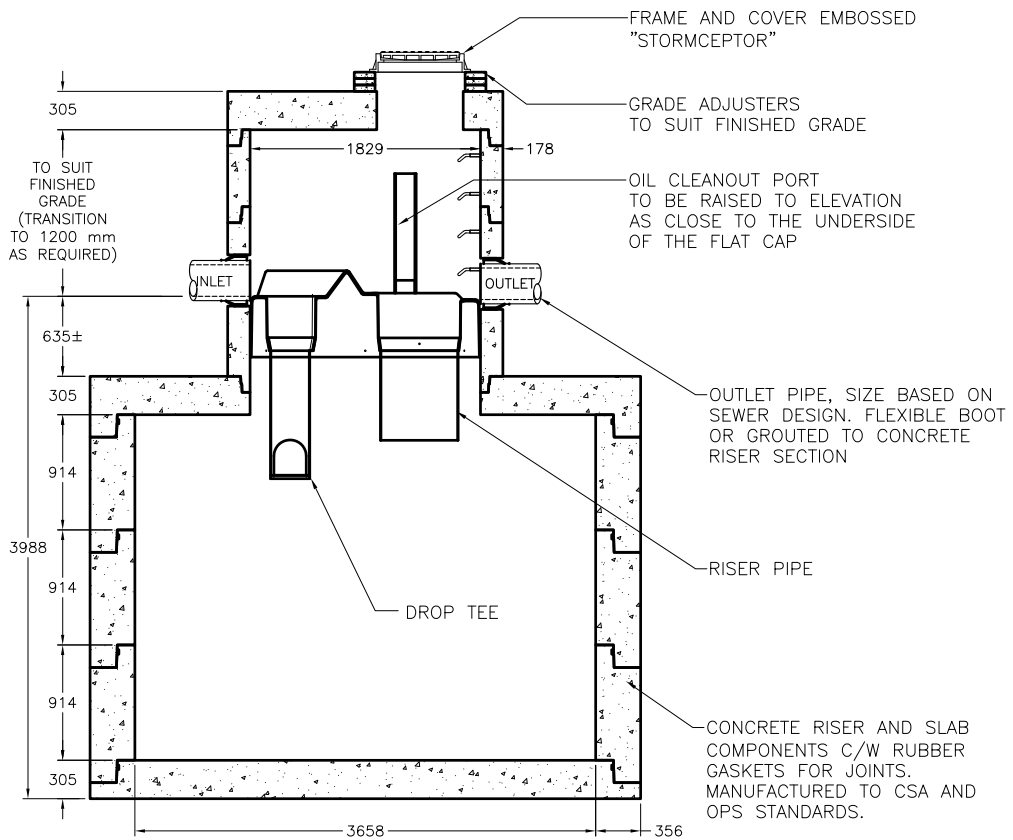

SECTION VIEW

Stormceptor

THE DESIGN AND INFORMATION SHOWN ON THIS DRAWING IS PROVIDED AS A SERVICE TO THE PROJECT OWNER, ENGINEER AND CONTRACTOR BY IMBRIUM SYSTEMS ("IMBRIUM"). NEITHER THIS DRAWING, NOR ANY PART THEREOF, MAY BE USED, REPRODUCED OR MODIFIED IN ANY MANNER WITHOUT THE PRIOR WRITTEN CONSENT OF IMBRIUM. FAILURE TO COMPLY IS DONE AT THE USER'S OWN RISK AND IMBRIUM EXPRESSLY DISCLAIMS ANY LIABILITY OR RESPONSIBILITY FOR SUCH USE. IF DISCREPANCIES BETWEEN THE SUPPLIED INFORMATION UPON WHICH THE DRAWING IS BASED AND ACTUAL FIELD CONDITIONS ARE ENCOUNTERED AS SITE WORK PROGRESSES, THESE DISCREPANCIES MUST BE REPORTED TO IMBRIUM IMMEDIATELY FOR RE-EVALUATION OF THE DESIGN. IMBRIUM ACCEPTS NO LIABILITY FOR DESIGNS BASED ON MISSING, INCOMPLETE OR INACCURATE INFORMATION SUPPLIED BY OTHERS.



7037 RIDGE ROAD, SUITE 305, HANOVER, MD 21076

866-740-3318 410-796-5505 866-376-8511 FAX

STC 6000
STANDARD MODEL

####

DATE:#####

SCALE: 60

REV #	DATE	REVISION DESCRIPTION	BY	SHEET NUMBER
				1
				OF 1

PROJECT No.: ##### DRAWN: ### CHECKED: ###

I:\AD\CONTECH-CPI\COMROO\TCORPORATE\MARKETING\IMBRIUM\CAD & PDF\STORMCEPTOR\CANADIAN\STC 6000.DWG 8/8/2016 10:18 AM



APPENDIX D
WATER BUDGET ANALYSIS

**Ainley Farm Subdivision
Township of Centre Wellington (Elora)
Monthly Water Balance (Thornthwaite and Mather Method)**

Date: February 2019

EXISTING CONDITION

Contributing Catchments:

Contributing Area = 22.70 ha

Percent Impervious = 0% %

All Soil Type: Clay Loam

Vegetation: Shallow-rooted crops

Root Zone Depth = 0.40m

Soil Moisture Retention Capacity = 100mm

Runoff Factor = 0.84

Evapotranspiration Factor for

Impervious Surfaces = 0.36

Month	Daily Average Temperature (°C)	Monthly Heat Index	Unadjusted Daily Potential Evapotranspiration (mm)	Correction Factors	Adjusted Potential Evapotranspiration (mm)	Average Precipitation (mm)	P-PE (mm)	Accum. Pot. Water Loss (mm)	Storage (mm)	ΔS (mm)	Pervious ET (mm)	Actual Evapotranspiration (mm)	Pervious ET - Actual ET (mm)	Moisture Deficit (mm)	Moisture Surplus (mm)	Water Runoff (mm)	Snow Melt Runoff (mm)	Total Recharge & Runoff (mm)	Actual Runoff (mm)	Runoff Volume (m ³)	Recharge Volume (m ³)
Jan	-7.40	0.00	0.00	24.3	0.00	67.90	67.9		236.5	0.0		0.0	0.0	0.0	0.0	9.9	0.0	9.9	8.3	1,894	352
Feb	-6.30	0.00	0.00	24.6	0.00	55.90	55.9		292.4	0.0		0.0	0.0	0.0	0.0	4.9	0.0	4.9	4.2	947	176
Mar	-1.90	0.00	0.00	30.6	0.00	59.60	59.6		352.0	0.0		0.0	0.0	0.0	0.0	2.5	0.0	2.5	2.1	474	88
Apr	5.70	1.22	0.90	33.6	30.24	74.10	43.9		100.0	0.0	30.2	30.2	0.0	0.0	43.9	21.9	25.2	47.1	39.7	9,020	1,679
May	12.20	3.86	2.00	37.8	75.60	86.90	11.3		100.0	0.0	75.6	75.6	0.0	0.0	11.3	16.6	113.4	130.0	109.6	24,883	4,630
Jun	17.50	6.66	2.90	38.4	111.36	83.80	-27.6	-27.6	75.0	-25.0	108.8	108.8	0.0	2.6	-2.6	7.0	56.7	63.7	53.7	12,197	2,270
Jul	20.00	8.16	3.40	38.7	131.58	89.20	-42.4	-69.9	49.0	-26.0	115.2	115.2	0.0	16.4	-16.4	-4.7	28.4	23.7	20.0	4,531	843
Aug	19.00	7.55	3.20	36.0	115.20	96.60	-18.6	-88.5	40.0	-9.0	105.6	105.6	0.0	9.6	-9.6	-7.1	14.2	7.0	5.9	1,347	251
Sep	14.90	5.22	2.50	31.2	78.00	93.10	15.1		55.1	15.1	78.0	78.0	0.0	0.0	0.0	-3.6	7.7	4.1	3.5	791	147
Oct	8.30	2.15	1.30	28.5	37.05	77.20	40.2		95.3	40.2	37.1	37.1	0.0	0.0	0.0	-1.8	4.0	2.2	1.9	424	79
Nov	2.10	0.27	0.30	24.3	7.29	93.00	85.7		100.0	4.8	7.3	7.3	0.0	0.0	81.0	39.6	2.5	42.1	35.5	8,055	1,499
Dec	-3.90	0.00	0.00	23.1	0.00	68.60	68.6		168.6	0.0		0.0	0.0	0.0	0.0	19.8	0.0	19.8	16.7	3,788	705
Total		35.1				945.9	359.6				557.8	557.8		28.5	107.6	105.1	252.0	357.1	301.1	68,350	12,719

Notes: Precipitation and Temperature data from Environment Canada Climate Normals 1981-2010 for Fergus Shand Dam
 Monthly water balance strategy as outlined in the document *Instructions and Tables for Computing Potential Evapotranspiration and the Water Balance (Thornthwaite and Mather, 1957)*
 Monthly Heat Index (I) from Table 2 of *Instructions and Tables for Computing Potential Evapotranspiration and the Water Balance*
 Correction Factors from Table 6 of *Instructions and Tables for Computing Potential Evapotranspiration and the Water Balance*
 Evaporation Factor for Impervious Surfaces = Average Annual Evapotranspiration for Impervious Surfaces (200mm/year) / Average Annual Evapotranspiration for Pervious Surfaces (558mm/year) = 0.36
 Runoff Factor = [(Impervious Percentage of Site x Average Annual Runoff for Impervious Surfaces (745.9mm/year)) + (Pervious Silt Till Percentage of Site x Average Annual Runoff for Pervious Silt Till Surfaces (301.1 mm/year))] / Total Annual Recharge

Ainley Farm Subdivision
Township of Centre Wellington (Elora)
Monthly Water Balance (Thornthwaite and Mather Method)
Date: February 2019

POST-DEVELOPMENT CONDITIONS - TO WETLAND

Contributing Catchments: All
 Contributing Area = 22.70 ha
 Percent Impervious = 36%

Soil Type: Clay Loam
 Vegetation: Shallow-rooted crops
 Root Zone Depth = 0.40m
 Soil Moisture Retention Capacity = 100mm

Runoff Factor = 0.95
 Evapotranspiration Factor for Impervious = 0.36

Month	Daily Average Temperature (°C)	Monthly Heat Index	Unadjusted Daily Potential Evapotranspiration (mm)	Correction Factors	Adjusted Potential Evapotranspiration (mm)	Average Precipitation (mm)	P-PE (mm)	Accum. Pot. Water Loss (mm)	Storage (mm)	ΔS (mm)	Pervious ET (mm)	Actual Evapotranspiration (mm)	Pervious ET - Actual ET (mm)	Moisture Deficit (mm)	Moisture Surplus (mm)	Water Runoff (mm)	Snow Melt Runoff (mm)	Total Recharge & Runoff (mm)	Actual Runoff (mm)	Runoff Volume (m ³)	Recharge Volume (m ³)	Enhanced Recharge (m ³)
Jan	-7.40	0.00	0.00	24.3	0.00	67.90	67.9		236.5	0.0		0.0	0.0	0.0	0.0	11.9	0.0	11.9	11.3	2,377	135	197
Feb	-6.30	0.00	0.00	24.6	0.00	55.90	55.9		292.4	0.0		0.0	0.0	0.0	0.0	6.0	0.0	6.0	5.7	1,189	68	98
Mar	-1.90	0.00	0.00	30.6	0.00	59.60	59.6		352.0	0.0		0.0	0.0	0.0	0.0	3.0	0.0	3.0	2.8	594	34	49
Apr	5.70	1.22	0.90	33.6	30.24	74.10	43.9		100.0	0.0	30.2	23.3	7.0	7.0	50.8	25.4	25.2	50.6	48.1	10,093	573	825
May	12.20	3.86	2.00	37.8	75.60	86.90	11.3		100.0	0.0	75.6	58.1	17.5	17.5	28.8	27.1	113.4	140.5	133.5	28,654	1,590	1,648
Jun	17.50	6.66	2.90	38.4	111.36	83.80	-27.6	-27.6	75.0	-25.0	108.8	83.7	25.1	27.7	22.6	24.8	56.7	81.5	77.5	16,234	922	1,351
Jul	20.00	8.16	3.40	38.7	131.58	89.20	-42.4	-69.9	49.0	-26.0	115.2	88.6	26.6	43.0	10.2	17.5	28.4	45.9	43.6	9,113	519	782
Aug	19.00	7.55	3.20	36.0	115.20	96.60	-18.6	-88.5	40.0	-9.0	105.6	81.2	24.4	34.0	14.8	16.2	14.2	30.3	28.8	6,009	343	532
Sep	14.90	5.22	2.50	31.2	78.00	93.10	15.1		55.1	15.1	78.0	60.0	18.0	18.0	18.0	17.1	7.7	24.8	23.5	4,908	280	438
Oct	8.30	2.15	1.30	28.5	37.05	77.20	40.2		95.3	40.2	37.1	28.5	8.6	8.6	8.6	12.8	4.0	16.8	16.0	3,330	190	298
Nov	2.10	0.27	0.30	24.3	7.29	93.00	85.7		100.0	4.8	7.3	5.6	1.7	1.7	82.6	47.7	2.5	50.2	47.7	10,007	568	827
Dec	-3.90	0.00	0.00	23.1	0.00	68.60	68.6		168.6	0.0		0.0	0.0	0.0	0.0	23.9	0.0	23.9	22.7	4,754	270	393
Total		35.1				945.9	359.6				557.8	429.0	128.8	157.3	236.4	233.4	252.0	485.4	461.2	97,261	5,492	7,438
																			Total Recharge Volume		12,930	
																			Total Enhanced Recharge Surplus (post-development volume - pre-development volume)		211	

Notes: Precipitation and Temperature data from Environment Canada Climate Normals 1981-2010 for Fergus Shand Dam
 Monthly water balance strategy as outlined in the document *Instructions and Tables for Computing Potential Evapotranspiration and the Water Balance (Thornthwaite and Mather, 1957)*
 Monthly Heat Index (I) from Table 2 of *Instructions and Tables for Computing Potential Evapotranspiration and the Water Balance*
 Correction Factors from Table 6 of *Instructions and Tables for Computing Potential Evapotranspiration and the Water Balance*
 Evaporation Factor for Impervious Surfaces = Average Annual Evapotranspiration for Impervious Surfaces (200mm/year) / Average Annual Evapotranspiration for Pervious Surfaces (558mm/year) = 0.36
 Runoff Factor = [(Impervious Percentage of Site x Average Annual Runoff for Impervious Surfaces (745.9mm/year)) + (Pervious Silt Till Percentage of Site x Average Annual Runoff for Pervious Silt Till Surfaces (301.1 mm/year))] / Total

Ainley Farm Subdivision
Township of Centre Wellington (Elora)
Monthly Water Balance (Thorntwaite and Mather Method)
Date: February 2019

Catchment 1200 - Design of Infiltration Structure

Infiltration Gallery No. 1

Length = 85.00 m
 Width = 3.50 m
 Depth= 0.87 m
 Perforated Pipe Diameter= 0.60 m
 No. of Pipes= 4.00

Area of Material = 297.50 sq m

Volume of Perforated Pipe 93.31
 Volume of Clear Stone = 165.52 cu m
 Clear Stone Void Ratio= 0.33

Total Storage Volume of Structure = 147.93 cu m

Infiltration Gallery No. 2

Length = 60.00 m
 Width = 5.00 m
 Depth= 0.87 m
 Perforated Pipe Diameter= 0.60 m
 No. of Pipes= 6.00

Area of Material = 300.00 sq m

Volume of Perforated Pipe 98.39
 Volume of Clear Stone = 162.61 cu m
 Clear Stone Void Ratio= 0.33

Total Storage Volume of Structure = 152.05 cu m

A = contact area of structure = 597.50 sq m
 V = runoff volume to be infiltrated = 299.98 cu m
 P = percolation rate of native soils = 4.00 mm/h
 n = porosity of storage media (weighted) = 0.68
 T = retention time = Solve for T

$T = (1000 \times V) / (P \times n \times A) = 183.47 \text{ hours or } 7.6 \text{ day draindown perio}$

Contributing Area 1.32 ha
 Recharge Time 183.5 hours 7.6 days
 Recharge Volume Potential 299.98 m³

Month	Total Runoff from Contributing Area (mm)	No. of days	Max Potential Recharge (m ³)	Available Recharge (m ³)	Enhanced Recharge (m ³)
Jan	11.0	31	1,216	145	138
Feb	5.5	28	1,099	72	69
Mar	2.7	31	1,216	36	34
Apr	44.8	30	1,177	591	562
May	124.6	31	1,216	1,645	1,156
Jun	76.2	30	1,177	1,006	956
Jul	46.9	31	1,216	620	589
Aug	33.9	31	1,216	447	425
Sep	28.2	30	1,177	373	354
Oct	19.4	31	1,216	256	243
Nov	46.0	30	1,177	607	577
Dec	21.9	31	1,216	290	275
Total	461.2	365	14,323	6,088	5,377

Ainley Farm Subdivision
Township of Centre Wellington (Elora)
Monthly Water Balance (Thorntwaite and Mather Method)
Date: February 2019

Catchment 1400 - Design of Infiltration Structure

Infiltration Gallery No. 3

Length = 80.00 m
 Width = 4.00 m
 Depth = 0.70 m
 Perforated Pipe Diameter = 0.60 m
 No. of Pipes = 3.00

Area of Material = 320.00 sq m

Volume of Perforated Pipe = 71.59
 Volume of Clear Stone = 152.41 cu m
 Clear Stone Void Ratio = 0.33

Total Storage Volume of Structure = 122.39 cu m

A = contact area of structure = 320.00 sq m
 V = runoff volume to be infiltrated = 122.39 cu m
 P = percolation rate of native soils = 4.00 mm/h
 n = porosity of storage media (weighted) = 0.54
 T = retention time = Solve for T

$T = (1000 \times V) / (P \times n \times A) = 175.73 \text{ hours or } 7.3 \text{ day draindown perio}$

Contributing Area 0.62 ha
 Recharge Time 175.7 hours / 7.3 days
 Recharge Volume Potential 122.39 m³

Month	Total Runoff from Contributing Area (mm)	No. of days	Max Potential Recharge (m ³)	Available Recharge (m ³)	Enhanced Recharge (m ³)
Jan	10.0	31	518	62	59
Feb	5.0	28	468	31	30
Mar	2.5	31	518	16	15
Apr	44.7	30	501	277	263
May	123.7	31	518	767	492
Jun	67.0	30	501	416	395
Jul	32.8	31	518	203	193
Aug	18.2	31	518	113	107
Sep	14.2	30	501	88	84
Oct	9.4	31	518	58	55
Nov	42.4	30	501	263	250
Dec	20.1	31	518	125	118
Total	390.1	365	6,101	2,418	2,061