

SCOPED HERITAGE IMPACT ASSESSMENT & CONSERVATION PLAN

7450 Middlebrook Road,
Elora, ON

Date:

November 21, 2022

Prepared for:

Melinda and Tim Croft

Prepared by:

**MacNaughton Hermsen Britton Clarkson
Planning Limited (MHBC)**

200-540 Bingemans Centre Drive
Kitchener, ON N2B 3X9

T: 519 576 3650

F: 519 576 0121

Project No. 21161B



MHBC
PLANNING
URBAN DESIGN
& LANDSCAPE
ARCHITECTURE

Table of Contents

Project Personnel	3
Glossary of Abbreviations	3
Acknowledgement of Indigenous Communities	4
Executive Summary	5
1.0 Introduction	6
1.1 Location of Subject Property	6
1.2 Heritage Status	9
1.3 Land Use and Zoning	10
2.0 Policy Context	12
2.1 The Planning Act and PPS 2020	12
2.2 Ontario Heritage Act	13
2.3 Wellington County Official Plan	13
2.4 Township of Centre Wellington Official Plan	14
2.5 County of Wellington Terms of Reference	15
3.0 Historical Overview	16
3.1 Indigenous Community and Pre-contact History	16
3.2 Historical Overview of the Village of Elora	16
3.3 Historical Overview of 7450 Middlebrook Road, "The McDonald Farmstead"	17
4.0 Detailed Description of Potential Cultural Heritage Resources	25
4.1 Description of Subject Property	25
4.1.1 Description of Built Features	26
4.1.2 Building Condition Report	32
4.1.3 Landscape Features	32
5.0 Evaluation of Cultural Heritage Resources	34
5.1 Evaluation Criteria	34
5.2 Evaluation of 7450 Middlebrook Road	35
5.2.1 Design/Physical Value	35

5.2.2	Historical/Associative Value	35
5.2.3	Contextual Value	35
5.2.4	List of Heritage Attributes	36
5.2.5	O-REG 9/06 EVALUATION.....	36
6.0	Description of Site Alteration.....	38
7.0	Impact Analysis	42
7.1	Introduction.....	42
7.2	Impact Analysis	43
7.2.1	7450 Middlebrook Road.....	43
7.3	Summary of Impacts	44
8.0	Mitigation Recommendations.....	45
9.0	Conservation Memo.....	46
9.1	Standards and Guidelines for the Conservation of Historic Places in Canada (2 nd Edition)	46
9.1.1	Review and Application of the Standards for Rehabilitation	46
9.1.2	Review and Application of the Guidelines.....	52
9.2	Eight Guiding Principles in the Conservation of Built Heritage Properties.....	52
9.3	Conservation Plan	53
	Short-Term (12 Months)	53
	Medium Term (24 Months).....	54
	Long Term (Maintenance and Monitoring).....	55
10.0	Conclusions.....	57
11.0	Bibliography.....	58
	Appendix A – Maps.....	60
	Appendix B – Site Plan and Architectural Drawings.....	61
	Appendix C –Tacoma Condition Assessment Report.....	62
	Appendix D – Scoped HIA Terms of Reference	63
	Appendix E–Curriculum Vitae	64

Project Personnel

Dan Currie, MA, MCIP, RPP, CAHP	<i>Managing Director of Cultural Heritage</i>	Senior Review
Rachel Redshaw, MA, HE Dipl, CAHP	<i>Senior Heritage Planner</i>	Co-author, Fieldwork, Research
Robyn McIntyre, BES	<i>Planner</i>	Field Work, Co-author

Glossary of Abbreviations

CHVI	<i>Cultural Heritage Value or Interest</i>
HIA	<i>Heritage Impact Assessment</i>
HCD	<i>Heritage Conservation District</i>
MHBC	<i>MacNaughton Hermsen Britton Clarkson Planning Limited</i>
MHSTCI	<i>Ministry of Heritage, Sport, Tourism and Culture Industries</i>
OHA	<i>Ontario Heritage Act</i>
OHTK	<i>Ontario Heritage Toolkit</i>
O-REG 9/06	<i>Ontario Regulation 9/06 for determining cultural heritage significance</i>
PPS 2020	<i>Provincial Policy Statement (2020)</i>

Disclaimers:

Maps and aerial photographs used in this document are for research purposes and not intended to be used for reproduction and/ or sale. The use of these maps and aerial photographs are to be protected under the fair use of copyrighted work.

Due to the Covid-19 pandemic, in-person research has been limited and therefore, this report may not be able to reference relevant hard copy sources that are within collections that are temporarily closed to the public.

Acknowledgement of Indigenous Communities

This Heritage Impact Assessment acknowledges that the subject property is located at 7450 Middlebrook Road, Elora, Ontario which is situated within territory of the Petun, Anishinabewaki, Anishinaabe, Mississaugas of the Credit First Nation, Missisauga and Odawa. These lands are acknowledged as being associated with the following treaties (accessed from www.native-land.ca):

- *Haldimand Treaty*
- *The Simcoe Patent, Treaty 4, 1793*

This document takes into consideration the cultural heritage of Indigenous communities including their oral traditions and history when available and related to the scope of work.

Executive Summary

A scoped Heritage Impact Assessment (HIA) was requested by the municipality for the proposed alterations to the property located at 7450 Middlebrook Road, Elora, Ontario which includes “The Fieldstone Barn”. This report has determined that the subject property has significant cultural heritage value or interest (CHVI) for its design/ physical, historical/ associative and contextual values. The property includes a farmhouse representative of the Gothic Revival architectural style as well as a stone, slit barn which is representative of a banked, fieldstone slit barn, however, unique in its mass and scale. The barn is an early example of a style, type and construction method for the fieldstone slit barn construction but also includes tenon and mortise joints in the interior of the barn and displays a high degree of craftsmanship. It has direct association with the theme of early agricultural Euro-Canadian farmsteads and can yield information as it relates to 19th century agricultural architecture in Centre Wellington. The property supports the agricultural character of the surrounding area and is functionally linked to the area as an operational agricultural property, and historically as it retains the original features of the historic farmstead which corresponds with others in the surrounding area.

In summary, the proposal has a beneficial impact as it will result in the adaptive re-use and long-term conservation of the buildings on-site, in particular, the slit barn. The report also identified a negligible adverse impact as a result of the alterations to the barn, however, these alterations are required for the adaptive re-use of the building and its overall conservation. The re-use of the barn for commercial purposes will likely have a positive economic impact which will allow for a stable form of funding for on-going maintenance required for a historic building. In order to mitigate impacts of proposed alterations, it is recommended that conservation measures outlined in Section 9.0 of this report, which are consistent with the *Standards and Guidelines for the Conservation of Historic Places in Canada*, be followed in order to ensure the least amount of intervention and therein impact.

1.0 Introduction

MHBC Planning, Urban Design and Landscape Architecture (“MHBC”) was retained in April of 2022 by Melinda and Tim Croft to undertake a scoped Heritage Impact Assessment (HIA) for the proposed development at 7450 Middlebrook Road, Elora, Ontario hereinafter referred to as “the subject property” (see Figure 1 and **Appendix ‘A’**). The development includes a proposed agri-tourism use within the existing barn which will require some alterations to support the use of the lower level for agricultural use and the upper level as an event space with mezzanine. New surface parking and laneways will also be introduced to facilitate the parking required for the new use of the barn.

The subject property is currently ‘listed’ (non-designated) as per Section 27 of the *Ontario Heritage Act (OHA)* on the *Centre Wellington’s Heritage Register*. The Register describes the property as a, “Three storey barn built in 1890 with coursed rubble, high gable roof, still used and maintained by current owner.”

The Township of Centre Wellington (“the municipality”) has requested a scoped HIA to review heritage values/ attributes and address potential impacts on the heritage resource(s) specifically the historic barn on the property, as a result of any proposed physical changes to the building (s) and/ or landscape. As part of this report, a scoped Conservation Plan is included in Section 9.0 of this report to ensure short, medium and long term conservation objectives are achieved.



1.1 Location of Subject Property

The subject property is located at 7450 Middlebrook Road, Elora (legal description is Pt Lt 1 Con A Wgr Pilkington Part 1, 61r9984, Centre Wellington). The property includes: a farmhouse, a shed/outbuilding, and a barn and includes some wooded areas and agricultural fields (see Figure 1). The total area of the subject property is approximately 7.2 hectares. The property is north of Middlebrook Road and the Grand River, west of Wellington Road 7 and the urban area of the Village of Elora, south of County Road 18 and east of one line west. The property is surrounded on the south, west and north by agricultural land.



Figure 1- Aerial view of subject property outlined in red and surrounding properties; approximate (Source: MHBC, 2022).

Table 1.0- Buildings and Structures on the Subject Property

Building/ Structures	Description	Photograph
Farmhouse	Two storey, wood frame single family dwelling in the Georgian architectural style.	
Slit-Barn	Three storey, banked, slit barn with southern wood addition.	
Shed/ Outbuilding	One storey wood frame outbuilding.	

1.2 Heritage Status

The subject property is a 'listed' (non-designated) property on the *Centre Wellington's Municipal Heritage Register*. The property is described as "3 storey barn built in 1890 with coursed rubble, high gable roof." The property is not adjacent to a 'listed' (non-designated) or designated property. Furthermore, the property is not located in the identified 'Heritage Area' as per Schedule A-1 of the *Township of Centre Wellington's Official Plan* or within a cultural heritage landscape as identified in the *Cultural Heritage Landscape Study of the Township of Centre Wellington*.



Figure 2- Aerial view of subject property and surrounding area; the red outline and yellow shading indicate the location of the subject property which is a 'listed' property (Source: MHBC, 2022).

1.3 Land Use and Zoning

The subject lands are split zoned with the majority identified as Agricultural (“A”) and a portion identified as Environmental Protection (“EP”). Additionally, the site has an Environmental Protection overlay extending from the Environmental Protection zone; this overlay exists on approximately half of the lot. These zones are identified in the Township of Centre Wellington Comprehensive Zoning By-law No. 2009-045 and are depicted by Figure 3, below:



Figure 3- Excerpt of Map 49 of Schedule 'A' of the Township of Centre Wellington's Zoning By-law; red boundary indicated location of the subject property (Source: Township of Wellington's Zoning By-law).

Section 6.0 of the Zoning Bylaw discusses the permitted uses within the Agricultural Zone. This zone permits: agricultural uses/buildings/structures, single detached dwellings, single detached dwellings accessory to an agricultural use, a group home, a commercial kennel, a lawfully existing institutional use, a pit or quarry, a temporary portable asphalt plant, and uses accessory to the foregoing. This zone has a minimum lot area of 10 hectares and a minimum lot frontage

of 120 metres. The maximum lot coverage is 1%. Various setbacks are in place for front, back, and side yard lot lines in addition to setbacks from various agricultural uses.

Section 9.0 includes discussion on the use of Environmental Protection zone. Permitted uses in the EP overlay include the following: agricultural uses, conservation and resource management, forest management, fish and wildlife management, flood or erosion control facilities, passive recreation, uses/buildings/structures existing prior to the passing of the zoning bylaw, and uses/buildings/structures accessory to the foregoing with the prior written approval of the Grand River Conservation Authority where applicable.

The permissions for the EP overlay are discussed in Section 9.2.3 of the Zoning Bylaw. This section states that the EP overlay identifies natural heritage features included in the 'Greenlands' Designation within the County & Township's Official Plans. The Environmental Protection overlay permits the uses and regulations of the underlying zone—in this instance, Agricultural. Where specific features are identified, the permissions for this overlay change. These features could include habitats, streams/valleys, significant woodlands, Environmentally Sensitive Areas, ponds/lakes/reservoirs, and or GRCA regulation areas. Details are included in Section 9.2.3.2 of the Zoning Bylaw.

2.0 Policy Context

2.1 The Planning Act and PPS 2020

The *Planning Act* makes a number of provisions respecting cultural heritage, either directly in Section 2 of the Act or Section 3 respecting policy statements and provincial plans. In Section 2, the *Planning Act* outlines 18 spheres of provincial interest that must be considered by appropriate authorities in the planning process. One of the intentions of *The Planning Act* is to “encourage the co-operation and co-ordination among the various interests”. Regarding cultural heritage, Subsection 2(d) of the Act provides that:

The Minister, the council of a municipality, a local board, a planning board and the Municipal Board, in carrying out their responsibilities under this Act, shall have regard to, among other matters, matters of provincial interest such as, ...

(d) the conservation of features of significant architectural, cultural, historical, archaeological or scientific interest;

The *Planning Act* therefore provides for the overall broad consideration of cultural heritage resources through the land use planning process.

In support of the provincial interest identified in Subsection 2 (d) of the *Planning Act*, and as provided for in Section 3, the Province has refined policy guidance for land use planning and development matters in the *Provincial Policy Statement, 2020* (PPS). The PPS is “intended to be read in its entirety and the relevant policy areas are to be applied in each situation”. This provides a weighting and balancing of issues within the planning process. When addressing cultural heritage planning, the PPS provides for the following:

2.6.1 Significant built heritage resources and significant cultural heritage landscapes shall be conserved.

Significant: *e) in regard to cultural heritage and archaeology, resources that have been determined to have cultural heritage value or interest. Processes and criteria for determining cultural heritage value or interest are established by the Province under the authority of the Ontario Heritage Act.*

2.6.3 Planning authorities shall not permit *development* and *site alteration* on *adjacent lands* to *protected heritage property* except where the proposed *development* and *site alteration* has been evaluated and it has been demonstrated that the *heritage attributes* of the *protected heritage property* will be *conserved*.

Built Heritage Resource: means a building, structure, monument, installation or any manufactured or constructed part or remnant that contributes to a property's cultural heritage value or interest as identified by a community, including an Indigenous community. Built heritage resources are located on property that may be designated under Parts IV or V of the Ontario Heritage Act, or that may be included on local, provincial, federal and/or international registers.

Protected Heritage Property: means property designated under Parts IV, V or VI of the Ontario Heritage Act; property subject to a heritage conservation easement under Parts II or IV of the Ontario Heritage Act; property identified by the Province and prescribed public bodies as provincial heritage property under the Standards and Guidelines for Conservation of Provincial Heritage Properties; property protected under federal legislation, and UNESCO World Heritage Sites.

2.2 Ontario Heritage Act

The *Ontario Heritage Act*, R.S.O., 1990, c.o.18 remains the guiding legislation for the conservation of significant cultural heritage resources in Ontario. This HIA has been guided by the criteria provided with *Regulation 9/06* of the *Ontario Heritage Act* outlines the mechanism for determining cultural heritage value or interest. The regulation sets forth categories of criteria and several sub-criteria.

2.3 Wellington County Official Plan

The Wellington County Official Plan provides policies under section 4.1 in regard to Cultural Heritage. Key policies include:

- ***Section 4.1.4 Heritage Areas***
"It is the policy of this plan that any development, redevelopment or public work shall respect the goals and objectives relating to the protection and enhancement of heritage resources, within designated Heritage Areas."
- ***Section 4.1.5 Policy Direction***

- a) Built heritage resources shall be conserved, in such a way that their heritage value, attributes, and integrity are retained;
- b) A HIA will be based on the heritage attributes or reasons why the attributes are significant;
- g) Where a property has been identified as a protected heritage property, development may be permitted on adjacent lands where it has been demonstrated that the heritage attributes will be protected; and
- h) The county recognizes the cultural significance of the Grand River as a Canadian Heritage River and the need to conserve its inherent values.

2.4 Township of Centre Wellington Official Plan

The Township of Centre Wellington Official Plan sets forth policies that guide heritage conservation and planning within the Township. In section B, the Plan maintains that Heritage Architecture is a unique quality that contributes to community value. As such, Goal 11 of the Plan is to “Protect the unique cultural heritage resources of the community”.

Section C.2 of the Centre Wellington Official Plan sets out the Goals and Objectives for protecting Cultural Heritage Resources, including to protect the Township’s heritage resources from redevelopment or changes in use which threaten their existence, to support the use of heritage buildings, to identify and protect natural areas, and to encourage public awareness and appreciation towards heritage resources.

Schedule A of the Official Plan identifies Heritage Areas within the Township. Section C.2.10 Development and Redevelopment speaks to development within Heritage Areas, stating that any development or redevelopment shall respect the goals and objectives relating to the protection of cultural heritage resources. The Township will encourage the design of new development that is compatible, sensitive, and sympathetic to existing heritage buildings or neighbouring buildings.

Section C.2.15 Heritage Resources Inventory states that the Township will complete an inventory of heritage resources as a means to increase awareness of existing heritage resources to owners and developers and Section C.2.18 Heritage Centre Wellington (LACAC) speaks to the appointment of a committee to aid council with the identification, conservation, protection and preservation of heritage resources. Responsibilities of the Committee include maintaining an inventory, conserving and preserving heritage features, preventing construction or alteration that would adversely impact heritage resources, and establish criteria for the approval of development affecting heritage properties.

This HIA will be guided by the policy framework of provincial, regional and local governments.

2.5 County of Wellington Terms of Reference

This heritage impact assessment is based on the requirements of Section 4.6.7 of the County Official Plan, which is as follows:

A heritage impact assessment and conservation plan may be required to determine if any significant cultural heritage resources are impacted by a development proposal.

In this case, the municipality has requested a scoped HIA and Conservation Memo. The following the required contents of an HIA are guided by the Ministry of Heritage, Sport, Tourism and Culture Industries *Info Sheet #5*:

- Historical research, site analysis and evaluation
- Identification of the significance and heritage attributes of the cultural heritage resources
- Description of the proposed development
- Assessment of development or site alteration impact
- Consideration of alternatives, mitigation and conservation methods. Methods to minimize or avoid a negative impact on a significant cultural heritage resource include:
 - Alternative development approaches
 - Isolating development and site alteration from significant built and natural features
 - Design guidelines that harmonize mass, setback, setting, and materials
 - Limit height and density
 - Allow only compatible infill and additions
 - Reversible alterations
 - Buffer zones, and
 - Site plan control
- Implementation and monitoring
- Summary statement and conservation recommendations

The Township of Centre Wellington has requested a scoped Heritage Impact Assessment which is:

- To review heritage values/attributes and address potential impacts on the heritage resource(s), specifically including the historic barn on the property, as a result of any proposed physical changes to the building(s) and/or landscape; and,
- A conservation plan (memo) should be prepared to ensure short and long term conservation objectives are achieved for identified heritage resources and their attributes.

3.0 Historical Overview

3.1 Indigenous Community and Pre-contact History

The Township of Centre Wellington is covered by several treaties and land cessions that occurred across southern Ontario. These treaties transferred land, and rights to land, between First Nations and the Crown. Particularly the Haldimand Proclamation Treaty established settlement patterns, which have led to the established communities within Centre Wellington. The Mississaugas of the Credit were the original occupants of the lands known today as Centre Wellington. In the late 1700's, during the American Revolution, the Six Nations entered into negotiations with the Crown for additional tracts of land as they had lost much of it during the war (Six Nations, 2019). This agreement or proclamation became known as The Haldimand Tract Treaty, which resulted in the Mississaugas of the Credit ceding a large portion of their land to the Crown. A portion of this ceded land was then granted to the Six Nations as a reward for their loyalty during the war which is known as the Haldimand Tract, which spanned approximately 10 kilometres on either side of the Grand River and provided the basis for the Six Nations reserve (Six Nations, 2019). Today, Elora resides on territory of the Haudenosaunee and what forms part of the Crown Grant to the Six Nations or Haldimand Tract (Ministry of Indigenous Affairs, 2021).

3.2 Historical Overview of the Village of Elora

In 1832, Captain Willian Gilkison purchased 14,000 acres in Nichol Township and subsequently founded the Village of Elora. It originally was called "Irvine Settlement" after Irvine Scotland, where Gilkison had lived prior to immigration to Canada (McLaughlin). The village was renamed upon the establishment of a post office in 1839 (McLaughlin). Elora was named after "Ellora", the name of Gilkison's brother's ship (McLaughlin). Within a year of its founding, Gilkison erected a sawmill and general store; by the following year, however, Gilkison passed away. In 1832, the land was originally laid out by Lewis Burwell at the time when it was called Irvine Settlement. Following this survey, the village was laid out by Charles Allan and Andrew Geddes along the west side of the Grand River and by 1848, lots were being sold.

In 1846, *Smith's Canadian Gazetteer* is described as "A Village in the township of Nichol, beautifully and romantically situated on the Grand River" (p 54). It states that at the time there were about 100 inhabitants, an Episcopal church and a Methodist Chapel (p 54). The industries were comprised of the following: "One physician and surgeon, one grist and oatmeal mill, one

saw mill, carding machine and cloth factory, one store, one tavern, one chemist and druggist, two blacksmiths, three shoemakers, two waggon makers and two tailors” (p 54).

The Village saw significant growth between 1850 and 1870 which included its incorporation in 1858. By 1869, the Village had a population of approximately 1,500 and the Village included other mills, two distilleries, carpet factory, tannery and two furniture factories in 1870 (McEvoy). The provision of Ontario Hydropower began in 1914 (Centre Wellington Hydro). In 1999, Elora amalgamated into the Township of Centre Wellington.

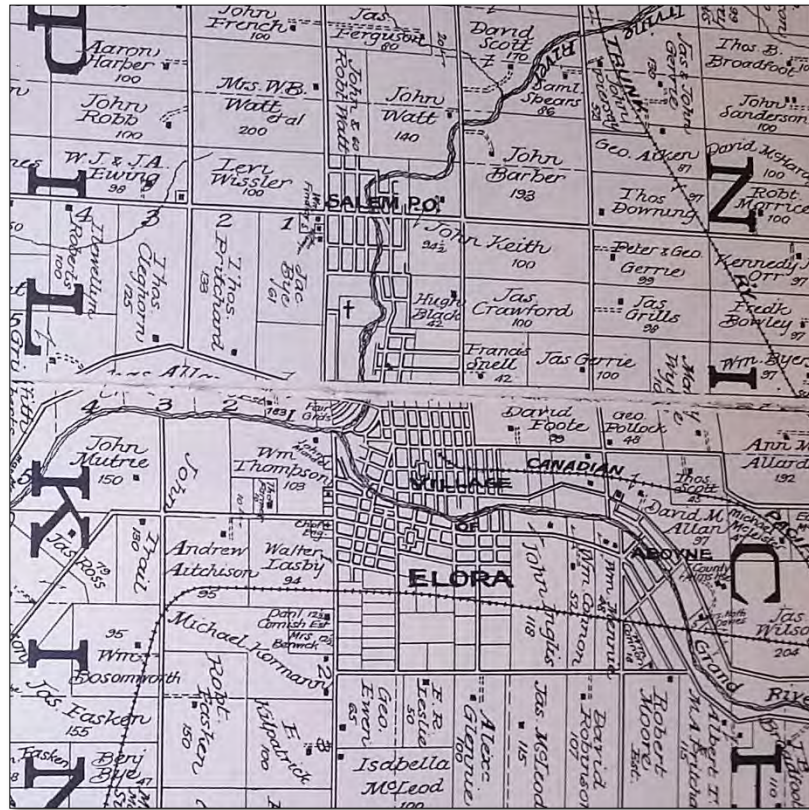

Figure 4- Excerpt of the 1861 Tremain Map of the County of Waterloo (Courtesy of the University of Waterloo Geospatial Centre, 2020).

3.3 Historical Overview of 7450 Middlebrook Road, “The McDonald Farmstead”

The first recorded resident on the subject lands was Allan McDonald, a widower originally from Scotland. Allan McDonald lived alone in a single storey log home on the lands and was there as

early as 1851 when the lands were still included in General Robert Pilkington's Estate. At this time, Pilkington Township's Tax Assessment Roll indicated that the property had a real estate value of £152 (Oakenwood Research Services, 2021). Allan McDonald was born in 1789 and was from the Island of Uist, Scotland (Library and Archives Canada).

Allan was recorded as the householder (likened to 'renter') of the subject lands in 1852 when the property had a recorded real estate value of £162 and again in 1853 when the property had a real estate value of £116. The 1853 Tax Assessment Roll indicates that the subject lands were 100 acres (Oakenwood Research Services, 2021).

In 1858, the Pilkington Township Tax Assessment Roll indicated two resident of the subject lands: The first was Jeremiah Callaghan, a 48 year-old mason living in a house with no acreage likely at the north end of the lot. Although the description of the barn in the Municipal Heritage Register is 1890, it is possible that the barn was actually constructed in the late 1850s or early 1860s when Jeremiah Callaghan occupied the north side of the lot which would make the dating more consistent with stone, slit barns in other parts of south western Ontario.

The second was Levi Erb of Salem, a non-resident with 66 acres of land indicated as "part of Lot 1, Concession A". There are no recordings of someone living at the southern end of the lot—being the subject property—however John McDonald, a 28 year-old farmer, was recorded as living at Lot 3, Concession A at the time of this census. As it was recorded that John's father, Allan McDonald, lived on the southern portion of Lot 1, Concession A, it is possible that "Lot 3" is a mistake in the transcription. It is possible that John lived on Lot 1, Concession A like his father and not Lot 3, Concession A (Oakenwood Research Services, 2021).

Allan's son, John McDonald, and his wife, Agnes McDonald (née Knox), took over ownership of Allan's lands between 1852 and 1860. In 1860, John McDonald took out a mortgage on 20 acres of the subject lands; land abstract indices for Pilkington Township indicate that this 20 acre mortgage was in the southern portion of 80 acres (Oakenwood Research Services, 2021). (note: property was 100 acres in 1853 and only 80 acres in 1860).

During the McDonald's ownership, two notable land transfers took place. In 1862, John McDonald along with Edward Tylee, a representative of Pilkington's Estate, gave 66 acres of the property to Levi Erb; the remainder of the lands were left to John McDonald. In 1865, John McDonald and his wife Agnes gave 0.5 acres of the remaining property to Jannett McDonald. No financial transactions were recorded for either of these transfers (Oakenwood Research Services, 2021).

John, Agnes, and their children: Allan, Adam, John, Agnes and William as well as Janet Knox (likely Agnes' sister) lived on the subject property. In the 1871 census, John is identified as a

'carpenter' and Janet as a 'seamstress' (see Figure 5). Based on the architectural style of the existing dwelling on-site and wood frame construction, it is likely that John McDonald constructed this building.

Year	Name	Sex	Age	Marital Status	Occupation	Other
1871	McDonald John	M	40	-	Scottland le Presb	Worshiper
	Agnes	F	37	-	W.S.	"
	Adam	M	14	-	0	"
	John	M	12	-	0	"
	Agnes	F	10	-	0	"
	William	M	5	-	0	"
	Janet	F	2	-	0	"
1871	Knox Janet	F	35	-	W.S.	Seamstress

Figure 5- Excerpt of the 1871 census of John McDonald and his family (Source: Library and Archives Canada).

At this time, the lot was 80 acres in total with 50 acres of cultivated land and 30 acres of naturalized forest. The McDonalds grew crops of spring wheat, peas, oats, potatoes, turnips, and hay in addition to their livestock which included cattle, horses, sheep, and pigs; the farm was estimated to be \$5,000 (Oakenwood Research Services, 2021).



Figure 6- Excerpt of 1861 George Tremaine Map of the County of Wellington; red outline indicates location of subject property (the Wellington County Archives and Museum).

In 1867, the McDonalds sold all but 1.5 acres of the land to Grace Allan. The McDonalds moved into Elora where they lived for the remainder of their lives with their children. John's occupation was recorded as transitioning from farmer to carpenter and then license inspector. Agnes McDonald passed away in 1902 and John McDonald in 1908 (Oakenwood Research Services, 2021).



Figure 7- Excerpt of 1877 Illustrated historical atlas of the County of Wellington (Courtesy of the Canadian County Atlas Digital Project).

John and Agnes McDonald then sold 1.0 acres of their land to Charles Allan Jr. in 1876. The property stayed in the Allan Family's custody and was transferred to Jemima Allan in 1915 by David M. Allan & wife, Martin Allan & wife, John D. Allan & wife, & Margaret Allan (Oakenwood Research Services, 2021).

Jemima Allan sold the farm to Harold K. Stark in 1931. Harold Stark was a baker in both Fergus and Elora who found himself in various legal troubles throughout his life. Notably, Stark was recorded as setting fire to a long home he owned that neighboured the subject lands in order to collect the insurance money (Oakenwood Research Services, 2021).

In the sale from Allan to Stark, Allan was recorded as “reserving rt re. spring – others”; this is the first indication of a well on the subject lands. This well was further recorded during a 1933 agreement between Stark and the Corporation of the Village of Elora in which the Village was provided the “right to install and maintain pipe to convey water from the spring for 9 years.” (Oakenwood Research Services, 2021). In the 1935 topographic map, it shows the barn and farmhouse.

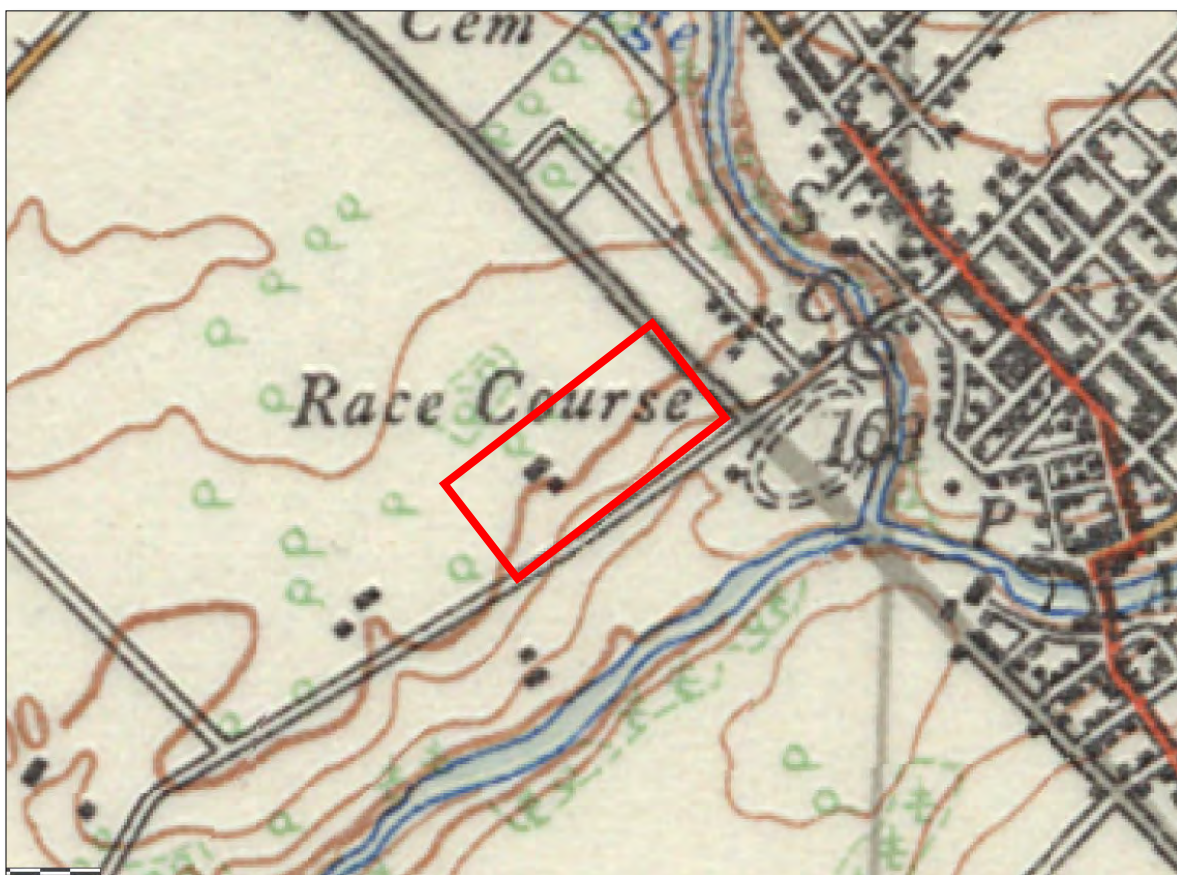

Figure 8- Topographic map from 1935 when Harold K. Stark owned the lands; red box identifying approximate location of subject property (Source: Ontario Council of University Libraries Historical Topographic Map Digitization Project).

Harold Stark owned the lands until 1940 when there were liens registered with his property. These liens remained in place until 1947 when the lands were transferred back to Harold and his wife. The Starks maintained ownership of the subject lands until 1953 when the 86-acre property was sold to George Maitland (Oakenwood Research Services, 2021).



Figure 9- 1945 aerial view of Elora, Ontario where the red arrow points to the subject lands that were under liens at the time, looking north from Grand River to cemetery, reference no. ph 4023 (Courtesy of the Wellington County Archives and Museum).



Figure 10- Excerpt of the 1954 aerial photo of Elora (and Nichol Township) (Source: University of Toronto Map Library, accessed 2021).

In 1957, George Maitland, Shirley Maitland, and David Maitland were recorded as farmers on the subject land's 80-acres of which 70 acres were cleared. At this time, the property was recorded as having a land value of \$2,100 and a building value of \$3,200. During Maitland's ownership of the property, he granted the Grand River Conservation Authority the "right to enter re. spring" in 1953 (Oakenwood Research Services, 2021).

Maitland and his wife took out a \$4,000 mortgage on the 86-acre property in 1968 which was transferred to another holder in 1972 before being fully paid off in 1975. No other land transactions were recorded for the property until 1978 (Oakenwood Research Services, 2021).

4.0 Detailed Description of Potential Cultural Heritage Resources

4.1 Description of Subject Property

The subject property is located at 7450 Middlebrook Road in the Township of Elora, Ontario. The lands are approximately 7.24 hectares (17.90 acres) in area with split frontage measuring approximately 309.00 metres (1,013.78 feet) on Middlebrook Road and approximately 51.60 metres (169.29 feet) on Wellington Road 7. Access to the lands is obtained via a gravel driveway connecting to Middlebrook Road.

The subject property contain three (3) buildings that are identified in Figure 11 below. The dwelling is one and a half storeys tall with stucco cladding. The shed/outbuilding is one storey with a wood frame construction. The barn is three storeys constructed of both masonry and wood (the addition).

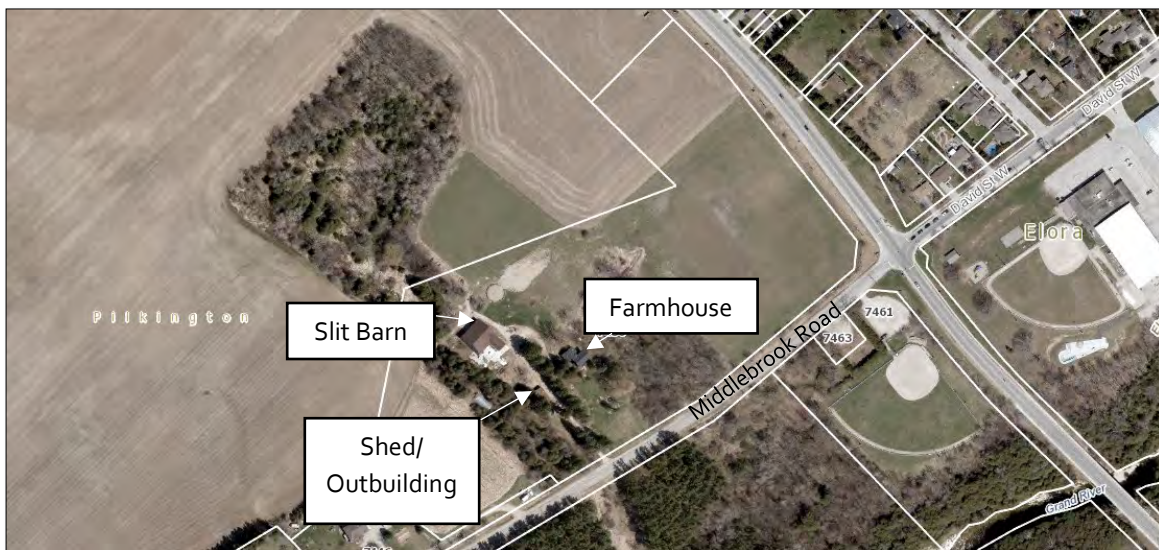

Figure 11- The locations of the three structures on the subject lands where the house is shown in the yellow circle, the shed in the blue circle, and the barn in the red circle. (Source: Township of Wellington Map Centre, 2022).

4.1.1 Description of Built Features

Farmhouse

The farmhouse on the subject property is clad in stucco with the exception of the addition on the north elevation which is of a wood frame construction clad in siding. The farmhouse has a low-pitched open gable roof line with returning eaves and the addition has a medium-pitched open gabled roofline. The front (south) elevation contains 5 window openings and centred entry with a pediment portico. The west elevation includes an enclosed addition/ sunroom and two window openings that appear to have been altered. The rear (south) elevation includes the rear addition which is 'tucked' under the returning eave of the north elevation of the farmhouse.



Figures 12 & 13- The front (southeast-facing) elevation of the dwelling (right) The left (southwest-facing) elevation of the house (Source: MHBC, 2022).

Shed/Outbuilding

There is a one storey wood frame shed / outbuilding with platform roofline. The building is along the west side of the main gravel driveway. This structure functions as a carport/ drive shed and has the capacity of approximately five vehicles.



Figures 14 & 15- (left) A view of the shed looking northwest from the base of the driveway (right) A view of the front (east-facing) elevation of the shed (Source: MHBC, 2022).

Slit Barn

Exterior

A three-storey field/ rubble stone banked slit barn located on the northwest portion of the subject property. The main barn has a rectangular footprint with an open gabled roof line constructed of metal sheathing and southern mid-century addition on the south with concrete foundation and wood frame construction with a gambrel roofline, also constructed of metal sheathing.



Figures 16 & 17- (left) The front (northwest-facing) elevation of the barn (right) A view of the east elevation with addition (Source: MHBC, 2022).



Figures 18-20- (left) The south elevation of the barn with gambrel barn addition (right) A view of the south elevation of main barn; (below centre) View of west elevation of main barn (Source: MHBC, 2022).

The main entry to the barn is on the north elevation, although there are human door entries on the other elevations. The north, east and west elevation include vertical slit openings which were used for ventilation. There are also louvered windows below the open gable on the west and east elevation of the main barn.

Interior

The main barn includes rows of narrow, slit openings and a centred window opening below the gable end. Some flooring and wood joists have been removed and replaced due to extreme deterioration. The mezzanine also was removed due to health and safety concerns and is planned to be reinstated.



Figures 21 & 22- (above) View of the interior of the west elevation; (below) View of the interior of the east elevation also showing interior of wood roof structure (Source: MHBC, 2022).

Work has commenced by masons to repair and repoint the existing masonry of the main barn structure; this process includes removing the existing mortar and replacing it with new lime based mortar.



Figures 23 & 24- (above) View of progress of repair to masonry on west elevation; ((below) View of progress of repair on lower level of south elevation (Source: MHBC, 2022).

The vertical slots begin as a larger rectangular opening in the interior and gradually narrow to the vertical 'slit' that is visible from the exterior of the building (Figure 22). The barn also includes mortise and tenon construction which is visible in Figure 23.



Figures 25 & 26- (above) Detailed view of stone slit opening construction from interior; (below) View of mortise and tenon construction in the interior of the barn (Source: MHBC, 2022).

4.1.2 Building Condition Report

Tacoma Engineers Inc. completed a condition assessment of the aforementioned barn on the subject lands in September, 2019 (see **Appendix 'C'**). Their report indicates that the barn can be visually separated into two sections: the original barn and the addition. The original barn was the focus of the building condition report. Tacoma noted deteriorating mortar and cracking walls throughout the barn. They recommended a lime-based mortar be used to repair the deterioration. Tacoma also noted potential, though not active, insect damage to the floor joists. They recommended reinforcing the joists and monitoring for further insect damage. Ultimately, Tacoma made recommendations in three categories:

- **Short Term (12 months) Remedial Action:** repair both the exterior masonry with a lime-based mortar and deterioration below windows with a compatible product.
- **Medium Term (24 months) Remedial Action:** replace or reinforce deteriorated joists in the original barn.
- **Items Requiring Routine Maintenance:** monitoring both drainage systems for the barn and the condition of the floor joists for potential insect damage.

4.1.3 Landscape Features

The property includes a tree-lined driveway leading northwards from Middlebrook Road and a tree-lined path eastward towards the house from the main driveway.

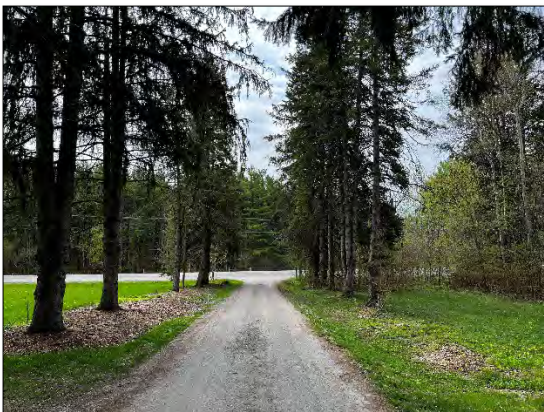

Figures 27 & 28- (above) View of tree-lined driveway; (below) View of tree-lined pathway to farmhouse (Source: MHBC, 2022).

The east and north elevation of the barn is surrounded by gravel, however, the west elevation includes a natural open space followed by a wooded area to the west. There is some split rail

fencing along the lane that runs parallel to the barn. The property includes some wooded areas and open agricultural fields.



Figures 29 & 30- (left) View looking southwards of immediate context/ setting of slit barn; (right) View looking eastwards towards slit-barn showing some split rail fencing (Source: MHBC, 2022).

5.0 Evaluation of Cultural Heritage Resources

5.1 Evaluation Criteria

The following sub-sections of this report will provide an analysis of the cultural heritage value of the subject property as per *Ontario Regulation 9/06*, which is the legislated criteria for determining cultural heritage value or interest. This criteria is related to design/physical, historical/associative and historical values as follows:

1. *The property has design or physical value because it:*
 - a. *Is a rare, unique, representative or early example of a style, type, expression, material or construction method,*
 - b. *Displays a high degree of craftsmanship or artistic merit, or*
 - c. *Demonstrates a high degree of technical or scientific achievement.*
2. *The property has historical value or associative value because it,*
 - a. *Has direct associations with a theme, event, belief, person, activity, organization or institution that is significant to a community,*
 - b. *Yields, or has the potential to yield, information that contributes to an understanding of a community or culture, or*
 - c. *Demonstrates or reflects the work or ideas of an architect, artist, builder, designer or theorist who is significant to a community.*
3. *The property has contextual value because it,*
 - a. *Is important in defining, maintaining or supporting the character of an area,*
 - b. *Is physically, functionally, visually or historically linked to its surroundings, or*
 - c. *Is a landmark.*

5.2 Evaluation of 7450 Middlebrook Road

5.2.1 Design/Physical Value

The three-storey barn is a representative of a banked, fieldstone slit barn. Slit barns, named for their long vertical slit windows, are rare, particularly ones that are of this mass and scale. This barn is an early example of a style, type and construction method for the fieldstone slit barn construction but also includes tenon and mortise joints in the interior of the barn. The barn displays a high degree of craftsmanship to construct a stone building of this size and the ability to adequately engineer the fieldstone walls with the inclusion of frequently placed slits for ventilation. It is likely that it was constructed around 1860 due to its construction method and composition (slit barns in the south-western Ontario were typically constructed in this time period) as well as the fact that the tax assessments indicate that a mason lived on the property in 1858 when the property was under the ownership of the McDonald Family.

The farmhouse is representative of the Georgian architectural style which is demonstrated by the symmetry of the front façade including the window openings, the centred entryway and returning gabled eaves.

5.2.2 Historical/Associative Value

The property has direct association with the theme of early agricultural Euro-Canadian farmsteads and can yield information as it relates to the construction of stone slit barns in Centre Wellington by Scottish settlers.

5.2.3 Contextual Value

The property is important in maintaining the character of the area which continues to be agricultural, although within proximity of the urban sprawl of Elora. It is functionally linked to its surroundings as an operating agricultural property.

5.2.4 List of Heritage Attributes

Farmhouse

- Original massing and scale;
- Original roofline of medium pitched open gabled roof;
- Centre hall plan including centred entryway and symmetrical placement of doors and windows;
- Original window and door openings including remaining original windows and doors (interior and exterior).

Barn

- Fieldstone construction including all elevations with the exception of the southern gambrel addition;
- Architectural elements including the vertical 'slits' in the west and east elevation and stone quoins;
- Original window and door openings including the segmental arched window openings under the gable of the west and east elevation;
- Interior mortise and tenon joint timber structural beams and posts;
- Interior loft ladder; and,
- Location and orientation of the barn in relation to the farmhouse.

5.2.5 O-REG 9/06 EVALUATION

Table 2.0

Ontario Regulation 9/06		7450 Middlebrook Rd
1. Design/Physical Value		
i.	Rare, unique, representative or early example of a style, type, expression, material or construction method	Yes.
ii.	Displays high degree of craftsmanship or artistic merit	Yes.
iii.	Demonstrates high degree of technical or scientific achievement	No.
2. Historical/Associative value		

iv.	Direct associations with a theme, event, belief, person, activity, organization, institution that is significant	No.
v.	Yields, or has potential to yield information that contributes to an understanding of a community or culture	Yes.
vi.	Demonstrates or reflects the work or ideas of an architect, artist, builder, designer, or theorist who is significant to the community.	No.
3. Contextual Value		
vii.	Important in defining, maintaining or supporting the character of an area	Yes.
viii.	Physically, functionally, visually, or historically linked to its surroundings	Yes.
ix.	Is a landmark	No.

5.2.5.1 Statement of Cultural Heritage Value

The property has cultural heritage value or interest for its design/ physical, historical/ associative and contextual values. The three-storey barn is a representative of a banked, fieldstone slit barn. Slit barns, named for their long vertical slit windows, are rare, particularly ones that are of this mass and scale. This barn is an early example of a style, type and construction method for the fieldstone slit barn construction but also includes tenon and mortise joints in the interior of the barn. The barn displays a high degree of craftsmanship to construct a stone building of this size and the ability to adequately engineer the fieldstone walls with the inclusion of frequently placed slits for ventilation. The farmhouse is representative of the Georgian architectural style which is demonstrated by the symmetry of the front façade including the window openings, the centred entryway and returning gabled eaves.

The property has direct association with the theme of early agricultural Euro-Canadian farmsteads and can yield information as it relates to the construction of stone slit barns in Centre Wellington in the 19th century.

The property is important in maintaining the character of the area which continues to be agricultural, although within proximity of the urban sprawl of Elora. It is functionally linked to its surroundings as an operating agricultural property. Furthermore, it is historically linked to the surrounding area as it retains the original features of the historic farmstead which corresponds with others in the surrounding area.

6.0 Description of Site Alteration

The property owners will be altering the site to function as a commercial property which includes: new circulation routes, including pedestrian paths, parking (including accessible parking) and landscape features such as the proposed garden to the west of the historic barn (see Figure 31). The majority of the new parking will be to the west of the farmhouse and barn and will be screened by existing vegetation and the improved circulation is required for a fire route. Also, the proposal includes the rehabilitation of the historic barn to operate as a commercial space for public events, private events, and seasonal markets. The basement storey of the original barn will function as storage space for the owners while the basement of the barn addition will operate as additional seasonal market space. These uses will be in place annually from May to October. The proposal does not include the removal of existing buildings or structures on the property or alteration to the general landscape.

In facilitating this project, the owners of 7450 Middlebrook Road have retained the services of Tacoma Engineers Inc. (CAHP), Fryett Turner Architects Inc., B.E.N. Stoneworks Ltd., and Fine Finish Renovations in addition to MHBC Planning Ltd. Together, this team is working to complete the proposed alterations to the barn:

- Repair and repointing of fieldstone masonry with lime based mortar;
- Installation of wood flooring (European Larch) and replace or reinforce deteriorated joists in the original barn;
- Rebuild mezzanine in the interior;
- Replace louvered window inserts with stained glass;
- Install new electrical system;
- Partition walls for shop space and washrooms on south side of barn;
- Roof repair/ replacement with like material;
- Install new window frames to replace rotten window frames at basement level;
- Replace main barn slider doors and human door entries with similar, new doors; and
- Concrete flooring in basement.

Architectural drawings and renderings related to the above proposal are included in **Appendix 'B'** of this report.

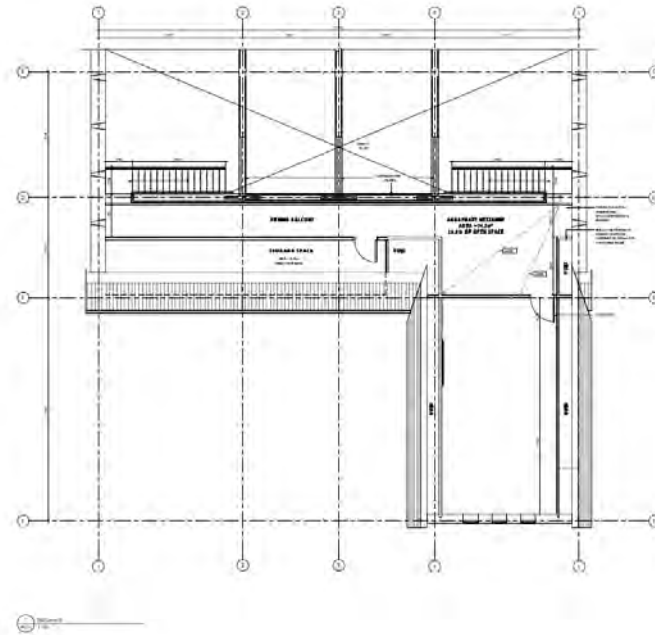
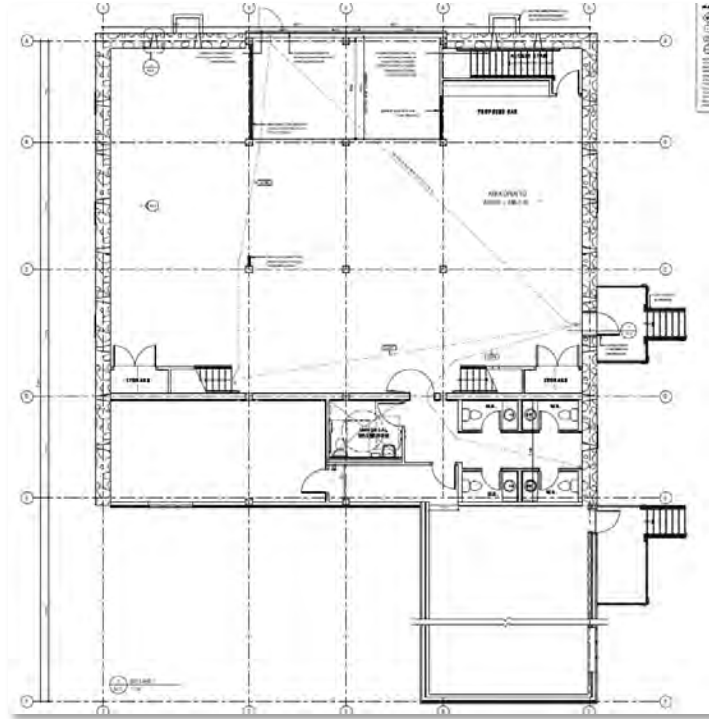

Figures 32 & 33- (above) Proposed main floorplan of the slit barn post rehabilitation; (below) Proposed second floor plan (Source: Fryett Turner Architects Inc.).

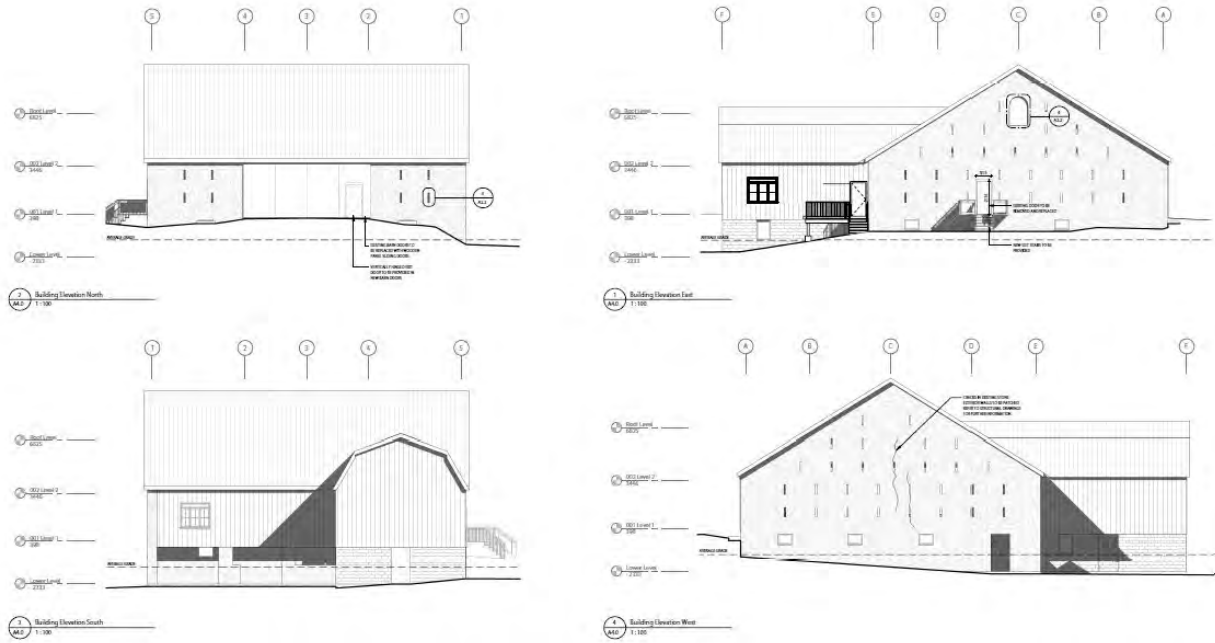

Figure 34- Proposed elevations of slit barn rehabilitation (Source: Fryett Turner Architects Inc.).

7.0 Impact Analysis

7.1 Introduction

The impacts of a proposed development or change to a cultural heritage resource may be direct or indirect. They may occur over a short term or long term duration, and may occur during a pre-construction phase, construction phase or post-construction phase. Impacts to a cultural heritage resource may also be site specific or widespread, and may have low, moderate or high levels of physical impact.

The following sub-sections of this report provide an analysis of the impacts which may occur as a result of the proposed development.

- **Destruction:** of any, or part of any *significant heritage attributes* or features;
- **Alteration:** that is not sympathetic, or is incompatible, with the historic fabric and appearance;
- **Shadows:** created that alter the appearance of a *heritage attribute* or change the viability of a natural feature or plantings, such as a garden;
- **Isolation:** of a *heritage attribute* from its surrounding environment, context or a significant relationship;
- **Direct or Indirect Obstruction:** of significant views or vistas within, from, or of built and natural features;
- **A change in land use:** such as rezoning a battlefield from open space to residential use, allowing new development or site alteration to fill in the formerly open spaces;
- **Land disturbances:** such as a change in grade that alters soils, and drainage patterns that adversely affect a cultural heritage resource.

This report utilizes guides published by the *International Council on Monuments and Site (ICOMOS)*, Council of UNESCO, from the World Heritage Convention of January of 2011. The grading of impact is based on "Guide to Assessing Magnitude of Impact" as a framework for this report:

Impact Grading	Description
Major	Change to key historic building elements that contribute to the cultural heritage value or interest (CHVI) such that the resource is totally altered. Comprehensive changes to the setting.

Moderate	Change to many key historic building elements, such that the resource is significantly modified. Changes to the setting an historic building, such that it is significantly modified.
Minor	Change to key historic building elements, such that the asset is slightly different. Change to setting of an historic building, such that is it noticeably changed.
Negligible/ Potential	Slight changes to historic building elements or setting that hardly affect it.
No change	No change to fabric or setting.

7.2 Impact Analysis

7.2.1 7450 Middlebrook Road

The adaptive re-use of the barn on-site is considered a beneficial impact as it will promote the long-term conservation of the significant cultural heritage resource. The proposed alterations including the cleaning and repair in addition to the repointing of masonry which is an integral part of the conservation of this building. Since taking ownership, the owners have stabilized the barn by reinforcing timber beams and posts in the basement.

The following **Table 4.0** evaluates the potential impacts as a result of the adaptive re-use of the barn:

<i>Impact</i>	<i>Level of Impact (Potential, No, Minor, Moderate or Major)</i>	<i>Analysis</i>
Destruction or alteration of heritage attributes	Negligible.	The alterations to the barn will not destroy or alter the farmhouse on-site. The proposed alterations to the barn will not negatively impact the barn. Some attributes may be required to be altered to ensure the building is consistent with the Ontario Building Code (OBC). There are also attributes that are beyond repair (rotting wood window frames and doors) that will be replaced with similar frames and doors.
Shadows	N/A	
Isolation	No.	The proposal will not isolate the property's attributes including its context value. All existing buildings and structures will remain

		in-situ as well as existing landscape features which retains the overall contextual value of the property.
Direct or Indirect Obstruction of Views	No.	There will no direct or indirect obstruction of views of the barn or farmhouse.
A Change in Land Use	No.	The change in the use of the barn for commercial purposes will benefit the long-term conservation of the building.
Land Disturbance	No.	There will not be ground/ earthworks that are required for the proposed alterations that will cause land disturbances.

7.3 Summary of Impacts

In summary, there is a beneficial impact as the retrofitting and adaptive re-use of the barn will provide a functional use for the building which is supportive of long-term conservation. There is also a negligible adverse impact as a result of the alterations to the barn, however, these alterations are required for the adaptive re-use of the building which is consistent with the overall conservation of the building. The re-use of the building for commercial purposes will likely have a positive economic impact which will allow for a stable form of funding for on-going maintenance required for a historic building.

8.0 Mitigation Recommendations

Section 7.0 impact analysis has identified a negligible impact of alteration as a result of the alterations to slit barn on the property. In order to mitigate impacts of alteration it is recommended that conservation measures that will be provided in the following Section 9.0 of this report be followed in order to ensure the least amount of impact to the significant cultural heritage resource.

9.0 Conservation Memo

The following sub-section briefly reviews the applicable conservation principles as it relates to the conservation of 7450 Middlebrook Road, Elora, Ontario. This Section reviews the Standards and Guidelines for the Conservation of Historic Places in Canada and the Eight Guiding Principles in the Conservation of Built Heritage Properties and provides short-term, medium-term and long-term conservation goals. Information related to this section can be viewed in **Appendix 'B'** and **Appendix 'C'** of this report.

9.1 Standards and Guidelines for the Conservation of Historic Places in Canada (2nd Edition)

9.1.1 Review and Application of the Standards for Rehabilitation

The Standards and Guidelines for the Conservation of Historic Places in Canada (2011) provide standards for rehabilitation; this includes the 12 General Standards:

- 1. Conserve the Heritage value of an historic place. Do not remove, replace or substantially alter its intact or repairable character-defining elements. Do not move a part of an historic place if its current location is a character-defining element.**

The proposal will conserve the historic place and will not remove, replace or substantially alter its intact or repairable character defining elements. Elements that will be removed or replaced or only elements that have are beyond repair and/ or risk to health and safety.

- 2. Conserve changes to a historic place that, over time, have become character-defining elements in their own right.**

The majority of the character-defining elements are original and limited, significant additions/ alterations have been made to either the farmhouse or barn.

3. Conserve heritage value by adopting an approach calling for minimal intervention.

The proposal was strategically planned with heritage professionals to approach the retrofitting of the barn in a manner resulting in the least intervention.

4. Recognize each historic place as a physical record of its time, place and use. Do not create a false sense of historical development by adding elements from other historic places or other properties, or by combining features of the same property that never existed.

A false sense of historical development will not be created within the retrofit.

5. Find a use for an historic place that requires minimal or no change to its character-defining elements.

The building will be used for commercial purposes including a local market and entertainment venue. These uses require minimal changes that are relevant to the Ontario Building Code to ensure health, safety and barrier free access.

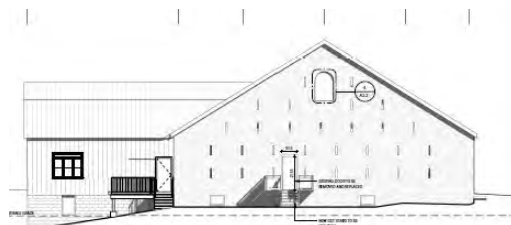

Figures 35 & 36- (above) Doorway that will be minimally altered to allow for barrier free access (Source: MHBC 2022) (below) Proposed elevation (Source: Fryett Turner Architects Inc., 2022).

- 6. Protect and, if necessary, stabilize an historic place until any subsequent intervention is undertaken. Protect and preserve archaeological resources in place. Where there is potential for disturbing archaeological resources, take mitigation measures to limit damage and loss of information.**

The heritage buildings are in good condition. Repair and repointing of masonry for the barn has already commenced, although the repair is not required to stabilize the structure. There are no archaeological resources perceived to be or identified on either the current site of the heritage building.



Figure 37- Detailed view of rubble stone facade (Source: MHBC 2022).

- 7. Evaluate the existing condition of character-defining elements to determine the appropriate intervention needed. Use the greatest means possible for any intervention. Respect heritage value when undertaking an intervention.**

The existing condition has been evaluated by Tacoma Engineers Inc. in 2019 by a member of the Canadian Association of Heritage Professionals (CAHP); they also determined the appropriate intervention corresponding to the identification of deteriorating mortar and cracking walls throughout the barn, recommending a lime-based mortar for repair.

- 8. Maintain character-defining elements on an ongoing basis. Repair character-defining elements by reinforcing their materials using recognized conservation methods. Replace in kind any extensively deteriorated or missing parts of character-defining elements, where there are surviving prototypes.**

An annual inspection of character-defining elements has been recommended in the long-term conservation goals of this report in Sub-section 9.3. The character-defining elements of the heritage barn will be repaired appropriately and materials reinforced. The owner has acquired two reputable conservators for these tasks: B.E.N. Stoneworks Ltd., and Fine Finish Renovations.

9. **Make any intervention needed to preserve character defining elements physically and visually compatible with the historic place and identifiable on close inspection. Document any intervention for future reference.**

The proposed intervention will be physically and visually compatible as this was taken into consideration during the assessment of the barn and the approach to its repair which is consistent with conservation principles.

10. **Repair rather than replace character-defining elements. Where character-defining elements are too severely deteriorated to repair, and where sufficient physical evidence exists, replace them with new elements that match the forms, materials and detailing of sound versions of the same elements. Where there is insufficient physical evidence, make the form, material and detailing of the new elements compatible with the character of the historic place.**

The majority of the character-defining elements are in good condition and do not require replacement. If replacement is required, there is sufficient physical evidence to replace them with new elements that match the forms, materials and detailing of sound versions of the same elements. The louvered window insert will be replaced with stained glass to better insulate the interior and to allow for more light for the venue.

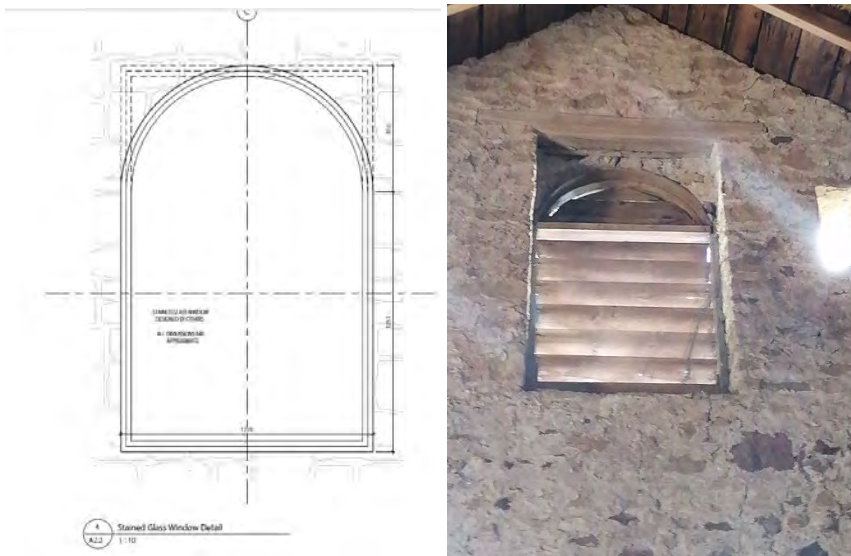

Figures 38 & 39- (above) Sketch of semi-arched window opening which is on the west and east elevation of the original barn (Source: Fryett Turner Architects Inc., 2022); (below) Photograph of semi-arched window opening of the slit-barn (Source: MHBC, 2022).

- 11. Conserve the heritage value and character-defining elements when creating any new additions to an historic place or any related new construction. Make the new work physically and visually compatible with, subordinate to and distinguishable from the historic place.**

The proposed new construction, which would include some partition walls in the later addition to facilitate washrooms (etc.) are intended to be physically and visually compatible to the historic barn.



Figures 40-42- (above) Proposed 3D renderings of the interior construction of the slit-barn (Source: Fryett Turner Architects Inc., 2022); (below left) View of south end of original barn installation of updated wood framing and joists; (below right) View of east end of southern portion of original barn transitioning to the south addition (Source: MHBC., 2022).

- 12. Create any new additions or related new construction so that the essential form and integrity of an historic place will not be impaired if the new work is removed in the future**

The work proposed in the interior of the barn to facilitate washrooms (etc) will be completed in a manner that is reversible and will not impair the building.

9.1.2 Review and Application of the Guidelines

The Standards and Guidelines (2011) provide specific guidelines regarding the conservation of elements of a historic place. The following guidelines for a) buildings and b) materials will be applied as it relates to the proposal and the conservation of heritage attributes located on the subject lands.

Guidelines for Buildings:

- Exterior Form;
- Exterior Walls; and,
- Roofs.

Guidelines for Materials:

- All Materials;
- Wood and Wood Products; and,
- Masonry.

9.2 Eight Guiding Principles in the Conservation of Built Heritage Properties

The following Eight Guiding Conservation Principles used by the Ontario Ministry of Tourism, Culture and Sport as well as the Ontario Heritage Trust will be evaluated in this report:

1. Respect for documentary evidence;

The barn has been documented through photographic documentation as well as by the project's architect for the purpose of designing the retrofitting.

2. Respect for original location;

The existing buildings on-site will remain in-situ.

3. Respect for historic material;

Any repairs as part of the retrofitting of the historic barn will be respectful of the existing historic material used including mortar.

4. Respect for original fabric;

The proposal will use original fabric (masonry) where feasible to make repairs to the barn.

5. Respect for the building’s history

The historic barn will be respectful of the property’s history and will be incorporated into the venue. The history of the barn is inherent in the marketing of the venue.

6. Reversibility;

The addition of partition walls to facilitate washrooms and other spaces will be completed in a manner that is appropriate and reversible.

7. Legibility;

Any alterations (i.e. mezzanine and flooring) will be compatible with the historic barn but should be legible as new and not historic.

8. Maintenance.

This report includes a Conservation Plan which includes maintenance in its long-term conservation goals.

9.3 Conservation Plan

Short-Term (12 Months)

Immediate Issue	Action	Project Team Member		
1. Security	For the duration of time that the building is no operating, it is important that the barn be monitored regularly to ensure that there is no evidence of trespassing or vandalism to the property. Regular inspections of the property should ensure that all smoke detectors	Owner		

	are properly operating and there are no fire hazards.			
2. Repair of Masonry	Repair both the exterior masonry with a lime-based mortar and deterioration below windows with a compatible product.	B.E.N. Stoneworks Ltd.		

Medium Term (24 Months)

	Action	Project Team Member
1. Repair/replace wood features	Replace or reinforce deteriorated joists in the original barn and flooring.	Fine Finish Renovations
2. Rebuild mezzanine	Rebuild mezzanine based on the form, material and style of the former mezzanine which had deteriorated.	Fine Finish Renovations Fryett Turner Architects Inc
3. Install new electrical system	Remove dated electrical system and install new electrical system for efficiently, functionality and safety.	Fine Finish Renovations
4. Retrofitting	Construct partition walls for shop space and washrooms in a reversible manner. Install washroom facilities.	Fine Finish Renovations Fryett Turner Architects Inc
5. Roof repair/ replacement	Roof repair or replacement with like material and style.	Fine Finish Renovations

<p>6. Repair/ replacement of window openings on basement level</p>	<p>Repair or replace window frames at basement level. Attempt to repair window frames, however, if they are too deteriorated, replace with frames that are of the same form, material and detailing.</p>	<p>Fine Finish Renovations</p>
<p>7. Replace door frames</p>	<p>Replace barn slider doors and human door entries with new doors as part of the retrofit. The doors should be of similar form, material and detailing.</p>	<p>Fine Finish Renovations</p>
<p>8. Install concrete basement</p>	<p>Install concrete basement as part of the retrofit for the shop for accessibility/ even walking surface.</p>	<p>Fine Finish Renovations</p>

Long Term (Maintenance and Monitoring)

Long term conservation is achieved through maintenance and regular monitoring. Regular maintenance is the best way to ensure that a cultural heritage resource is appropriately conserved over the long-term and ensures that damages (including wear and tear, exposure to the elements) are routinely inspected and repaired as necessary. By maintaining a status quo, there should not be the requirement to replace heritage attributes and the need for major interventions. All maintenance, repair or restoration or new design should respect heritage attributes and the original fabric or historic materials, should be based on the documentary evidence.

Attributes and elements of a building will deteriorate over time through daily use. As such, all materials are expected to have a 'lifetime'. It is recommended that the elements of the building be routinely inspected on an annual basis to repair elements which are at the end of their lifespan, including roof and windows for example. Major elements should be considered for repair or replacement at the end of their life spans, including roofs (20+ years), doors and windows (20-30+ years) and masonry (+/- 100 years). The average lifespans of these elements vary greatly and thus a detailed review is required. In order to supplement the historic record, it is recommended that a record of all restoration and maintenance work is documented over time. Conservation measures for the long-term include regular monitoring and maintenance to uphold the level of care and function that is apparent today. Regular monitoring will identify maintenance issues to be addressed on an ongoing basis. On-going maintenance consists of visual assessments to identify any commencement of deterioration that can be intervened at the earliest time possible.

Table 7.0		
Long-Term	Action	Time Frame
Maintenance Record Keeping	That a record be kept of maintenance and repairs over the long-term to supplement the historic record of the building.	<i>Annually</i>
Cleaning of Heritage Attributes	Heritage elements/ features should be cleaned safely following the correct protocol for cleaning techniques of each particular feature subsequent to its material.	<i>Every five (5) years</i>
Monitor Drainage and Condition of Wood Features	Monitor drainage systems for the barn and the condition of the floor joists for potential insect damage.	<i>Monthly</i>

10.0 Conclusions

In conclusion, this scoped Heritage Impact Assessment has determined that the subject property has significant cultural heritage value or interest for its design/ physical, historical/ associative and contextual values. The property includes a farmhouse representative of the Gothic Revival architectural style as well as a stone, slit barn which is representative of a banked, fieldstone slit barn, however, unique in its mass and scale. The barn is an early example of a style, type and construction method for the fieldstone slit barn construction but also includes tenon and mortise joints in the interior of the barn and displays a high degree of craftsmanship. It has direct association with the theme of early agricultural Euro-Canadian farmsteads and can yield information as it relates to 19th century agricultural architecture in Centre Wellington. The property supports the agricultural character of the surrounding area and is functionally linked to the area as an operational agricultural property, and historically as it retains the original features of the historic farmstead which corresponds with others in the surrounding area.

In summary, the proposal has a beneficial impact as it will result in the adaptive re-use and long-term conservation of the building. There is also a negligible adverse impact as a result of the alterations to the barn, however, these alterations are required for the adaptive re-use of the building and overall conservation of the building. The re-use of the building for commercial purposes will likely have a positive economic impact which will allow for a stable form of funding for on-going maintenance required for the historic building. In order to mitigate impacts of alteration it is recommended that conservation measures in Section 9.0 of this report be followed in order to ensure the least amount of impact.

11.0 Bibliography

- County of Wellington Official Plan. June 1, 2022 consolidation. Adopted September 24th, 1998. Approved by the Ministry of Municipal Affairs April 13, 1999. Came into effect May 6, 1999.
- Centre Wellington Hydro. A History of the Electrical Industry in Fergus and Elora. (PDF).
- Library and Archives Canada; Ottawa, Ontario, Canada; *Voters Lists, Federal Elections, 1935-1980*
- Library and Archives Canada. *Sixth Census of Canada, 1921*. Ottawa, Ontario, Canada: Library and Archives Canada, 2013. Series RG31. Statistics Canada Fonds.
- McLaughlin, Kenneth. "Elora". The Canadian Encyclopedia. November 9, 2009. Accessed September 13, 2021. Elora | The Canadian Encyclopedia
- Ontario Ministry of Tourism Culture and Sport. Ontario Heritage Act Ontario Heritage Act 2005, R.S.O. 1990, c. o.18 . Retrieved from the Government of Ontario website: <https://www.ontario.ca/laws/statute/90o18>.
- Oakenwood Research Services (27 July, 2021). Prepared for Melinda Croft regarding 7450 Middlebrook Road, Elora, ON, NoB 150.
- Ontario Ministry of Tourism, Culture and Sport. Ontario Heritage Tool Kit: Heritage Resources in the Land Use Planning Process, InfoSheet #5 Heritage Impact Assessments and Conservation Plans . Queens Printer for Ontario, 2006.
- Six Nations. "Land Rights: A Global Solution for the Six Nations of the Grand River". Impact Assessment Agency of Canada, 2019. <https://iaac-aeic.gc.ca/050/documents/p80100/130877E.pdf>.
- Township of Centre Wellington, Municipal Official Plan. Adopted November 24th, 2003. Approved May 31st, 2003.
- Township of Centre Wellington Comprehensive Zoning Bylaw No.2009-045. Office consolidation from February 2018.

MAPS & IMAGES

- Google Maps & Google Earth Pro. 7450 Middlebrook Road, Elora, *Ontario*. Accessed May 8, 2022.
- Topographic maps of the Village of Elora from 1935 and 1939*. Courtesy of the Ontario Council of University Libraries Historical Topographic Map Digitization Project.
- Tremaine, George R. *Map of Waterloo County, Canada West. Compiled and Drawn from Actual and Original Surveys*. George R. and G.M. Tremaine, Toronto, Ontario, 1861.

Unknown. 1954 aerial photograph of southwestern Ontario. Courtesy of the University of Toronto Map Library, accessed 2021. [1954 Air Photos of Southern Ontario | Map and Data Library \(utoronto.ca\)](#).

Appendix A – Maps



Location Map

LEGEND

 Subject Lands

DATE: May 2022

SCALE: 1:7,500

FILE: 21161B

DRAWN: LC

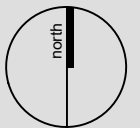

K:\21161B - HIA MIDDLEBROOK ROAD, ELORA\RP\TLOCATION.DWG

7450 Middlebrook Road
Elora, ON
Wellington County



MHBC PLANNING
URBAN DESIGN
& LANDSCAPE
ARCHITECTURE
200-540 BINGEMANS CENTRE DR. KITCHENER, ON, N2B 3X9
P: 519.576.3650 F: 519.576.0121 | WWW.MHBCPLAN.COM



Listed Property

7450 Middlebrook Road
 Elora, ON
 Wellington County

LEGEND

-  Subject Lands
-  Listed Property

DATE: May 2022

SCALE: 1:7,500

FILE: 21161B

DRAWN: LC

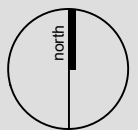

K:121161B - HIA MIDDLEBROOK ROAD, ELORA\IPTLISTED PROPERTY.DWG

MHBC PLANNING
 URBAN DESIGN
 & LANDSCAPE
 ARCHITECTURE

200-540 BINGEMANS CENTRE DR. KITCHENER, ON, N2B 3X9
 P: 519.576.3650 F: 519.576.0121 | WWW.MHBCPLAN.COM



**1861 Historical
County Map of
Wellington County**

LEGEND

 Subject Lands

DATE: May 2022

SCALE: 1:10,000

FILE: 21161B

DRAWN: LC

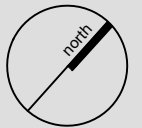

K:\21161B - HIA MIDDLEBROOK ROAD, ELORA\RP\HISTORIC OVERLAY.DWG

**7450 Middlebrook Road
Elora, ON
Wellington County**

MHBC PLANNING
URBAN DESIGN
& LANDSCAPE
ARCHITECTURE
200-540 BINGEMANS CENTRE DR. KITCHENER, ON, N2B 3X9
P: 519.576.3650 F: 519.576.0121 | WWW.MHBCPLAN.COM



**1877 Illustrated
Historical Atlas of
the County of
Wellington**

LEGEND

 Subject Lands

DATE: May 2022

SCALE: 1:12,500

FILE: 21161B

DRAWN: LC



K:\21161B - HIA MIDDLEBROOK ROAD, ELORA\RP\HISTORIC OVERLAY.DWG

7450 Middlebrook Road
Elora, ON
Wellington County

MHBC PLANNING
URBAN DESIGN
& LANDSCAPE
ARCHITECTURE
200-540 BINGEMANS CENTRE DR. KITCHENER, ON, N2B 3X9
P: 519.576.3650 F: 519.576.0121 | WWW.MHBCPLAN.COM

Appendix B – Site Plan and Architectural Drawings

2022-03-02 4:01:57 PM

1 Site
A1.0 1 : 400

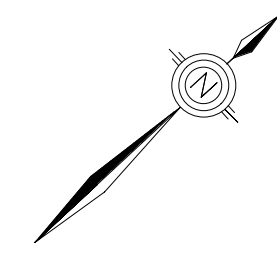

SITE PLAN LEGEND

- GRASS OR NATURAL LANDSCAPE AREA
- TREE CANOPY
- EXISTING CROP FIELD
- POND
- GRAVEL
- CONCRETE
- EXISTING BUILDING STRUCTURES
- EXISTING BUILDING STRUCTURE WITH AREA OF DEVELOPMENT
- GRCA REGULATED WETLAND
- STREAM
- FENCE
- FIRE ROUTE

NOTES:
 1) PROJECT TO BE COMPLETED IN TWO PHASES. ALL SITE WORK SHOWN TO BE COMPLETED IN PHASE 1 UNLESS NOTED OTHERWISE.
 2) EXTENTS OF EXISTING SITE MATERIALS AND TREE CANOPY COVERAGE ARE APPROXIMATE.

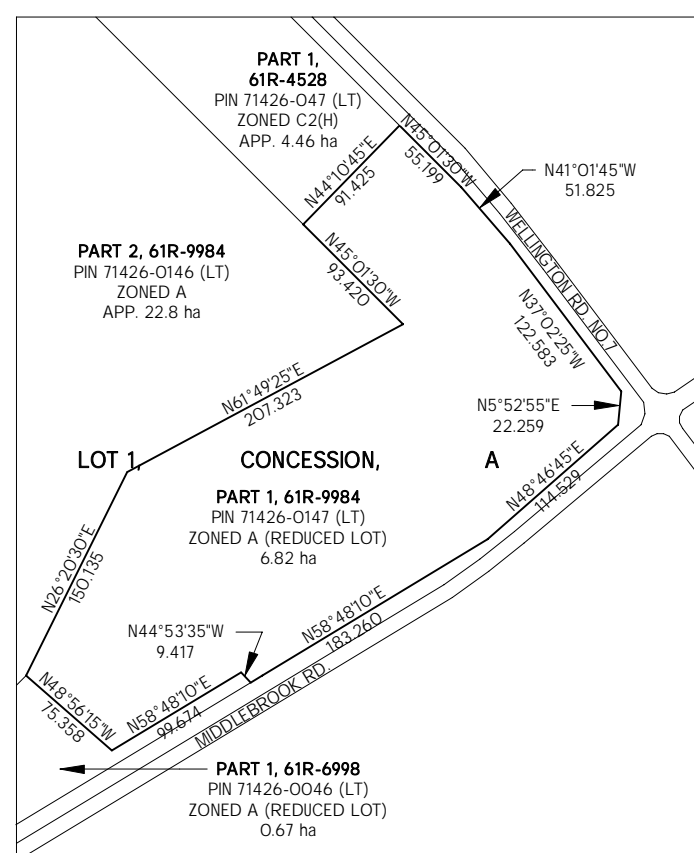

THE CONTRACTOR SHALL VERIFY ALL DIMENSIONS IN THE COURSE OF THE WORK. THE ARCHITECT SHALL BE RESPONSIBLE FOR THE WORK UNDER NO CIRCUMSTANCES SHALL THE CONTRACTOR PROCEED IN UNCERTAINTY.
 ALL DRAWINGS AND SPECIFICATIONS PREPARED BY THE ARCHITECT SHALL BE FOR THE ARCHITECT'S USE ONLY AND ARE TO BE RETURNED AT HIS REQUEST.
 © COPYRIGHT
 DO NOT SCALE DRAWINGS.

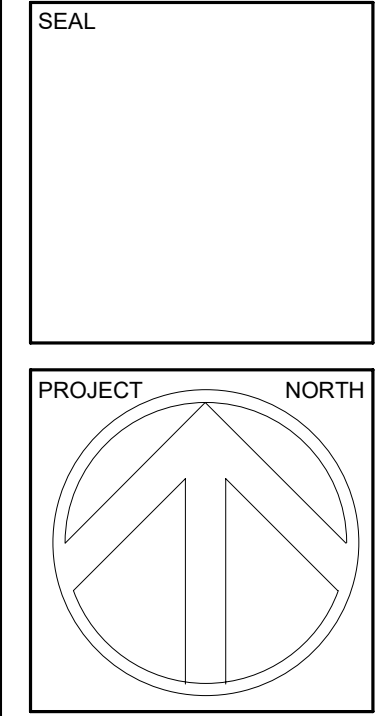

Middlebrook Barn
 7450 Middlebrooke Rd. Elora
 Site Plan

STATUS	Repair Permit
PROJECT #	20037
CHKD	RT
DRAWN	MA
SCALE	As indicated
DATE DWN	20200723
ISSUED	20220302

REVISIONS	DATE

A1.0

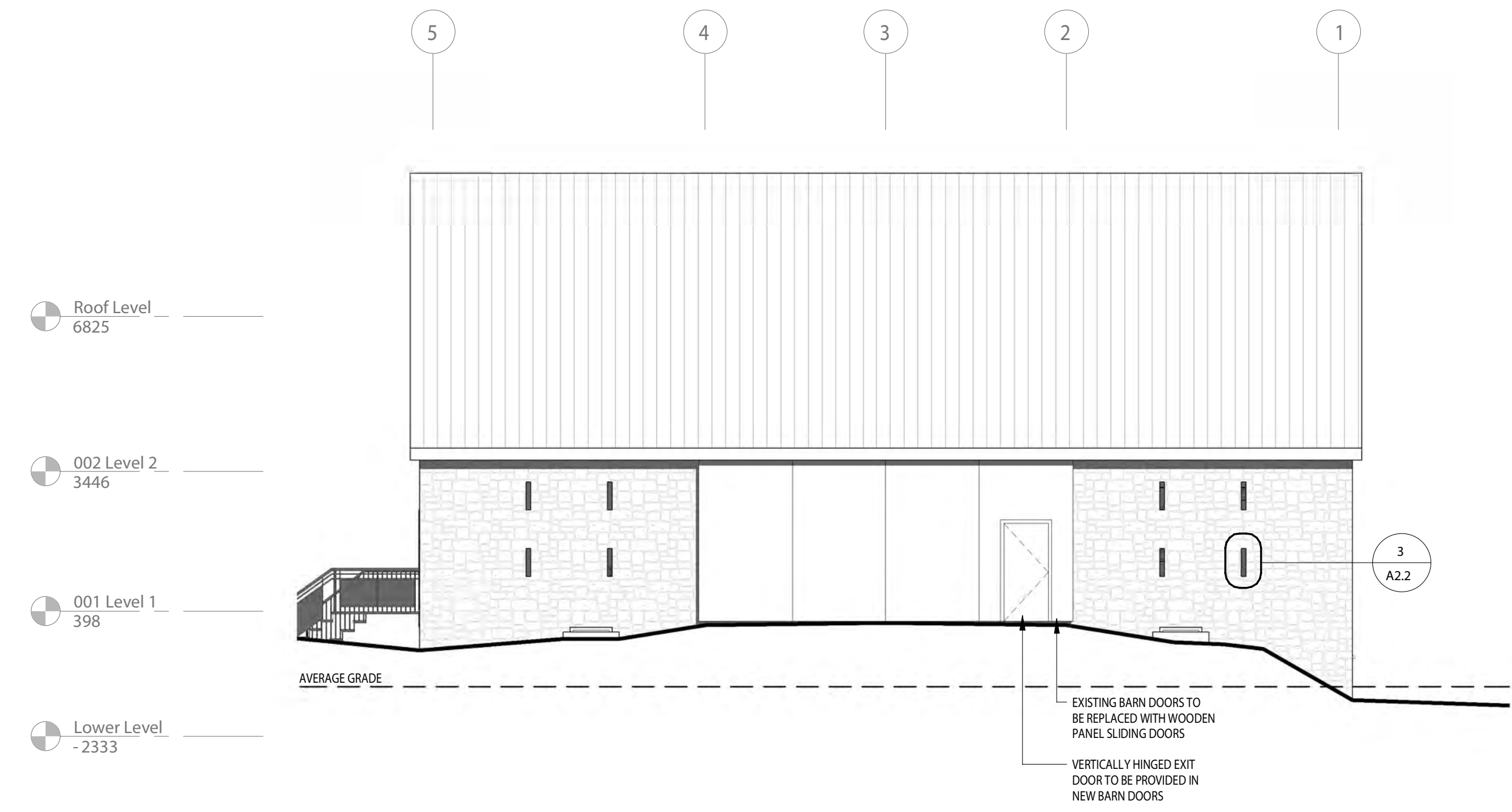

2 Building Elevation North
A4.0 1:100

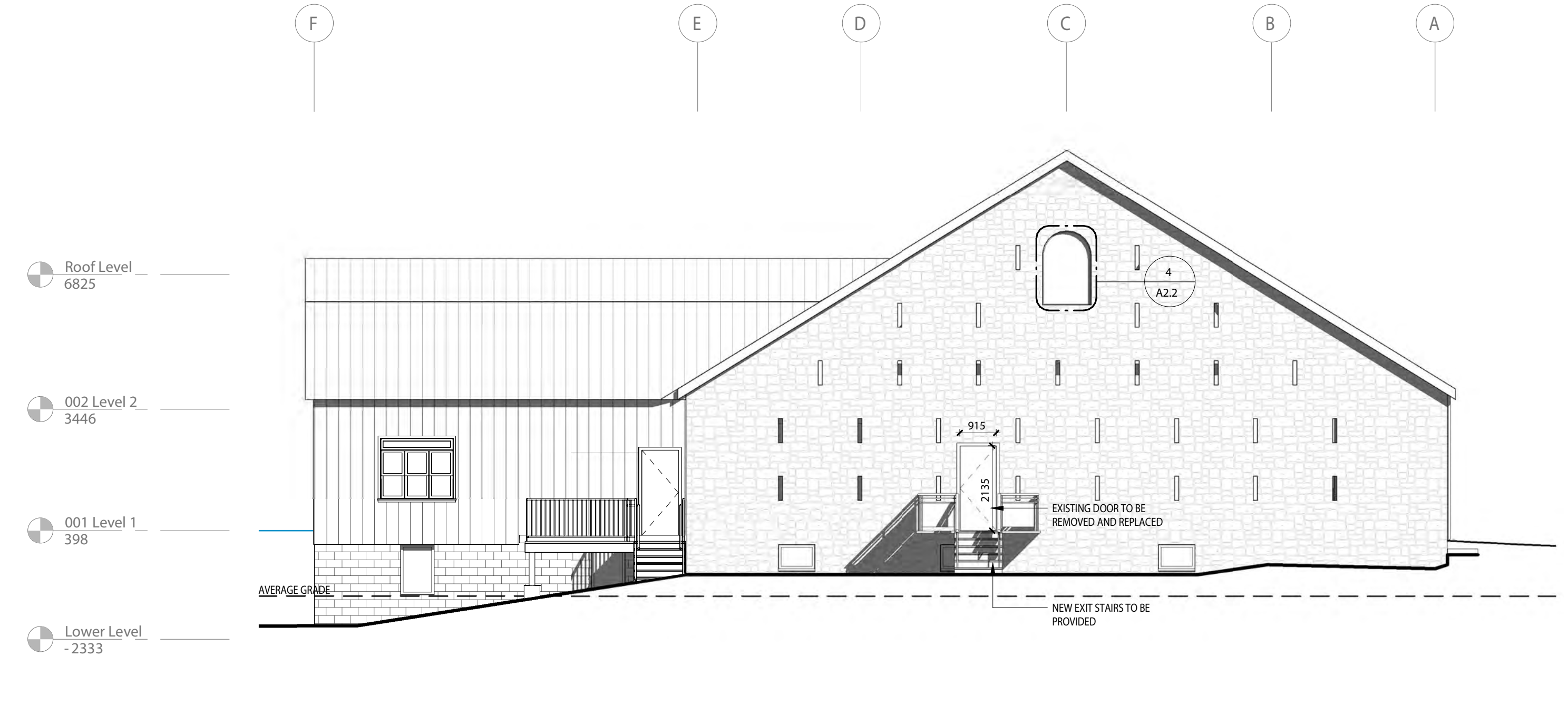

1 Building Elevation East
A4.0 1:100

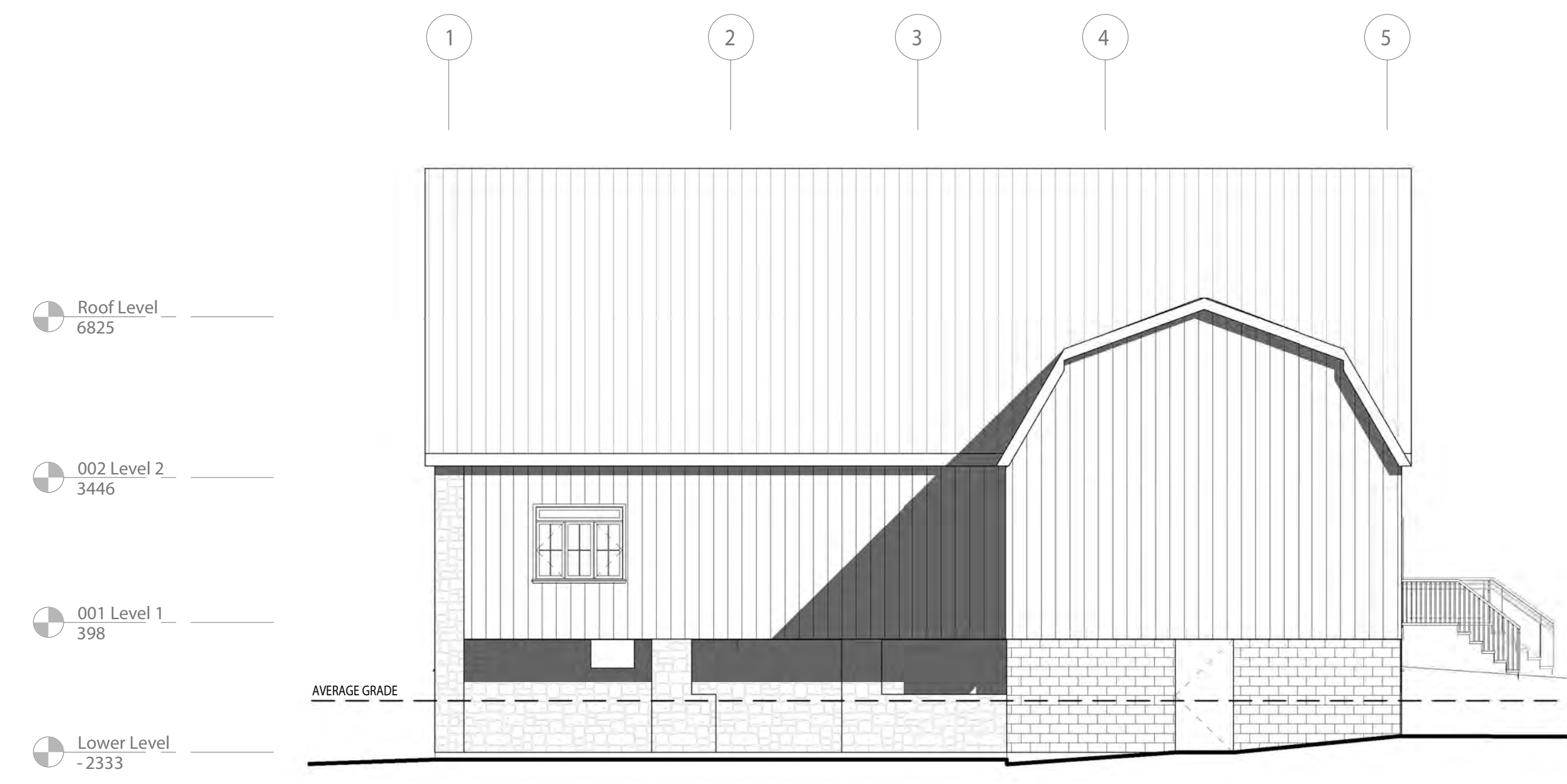

3 Building Elevation South
A4.0 1:100

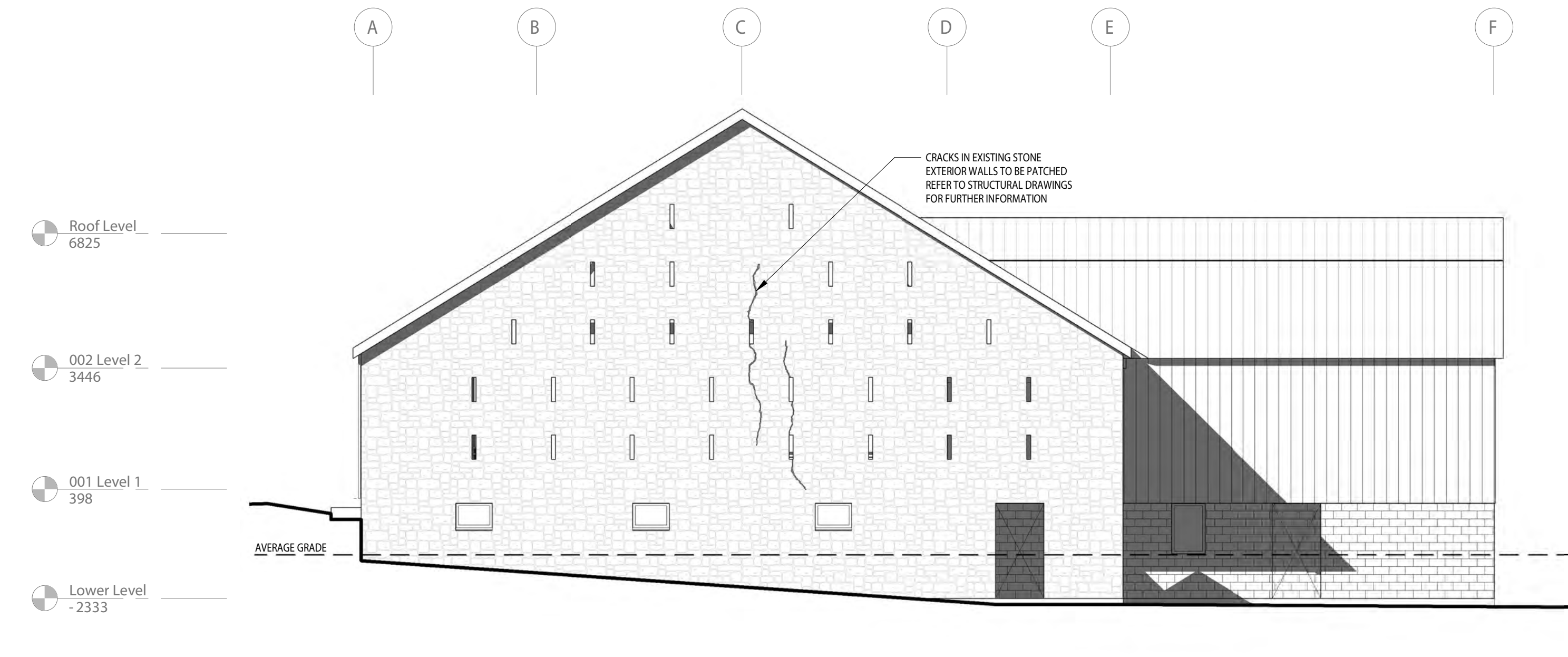

4 Building Elevation West
A4.0 1:100

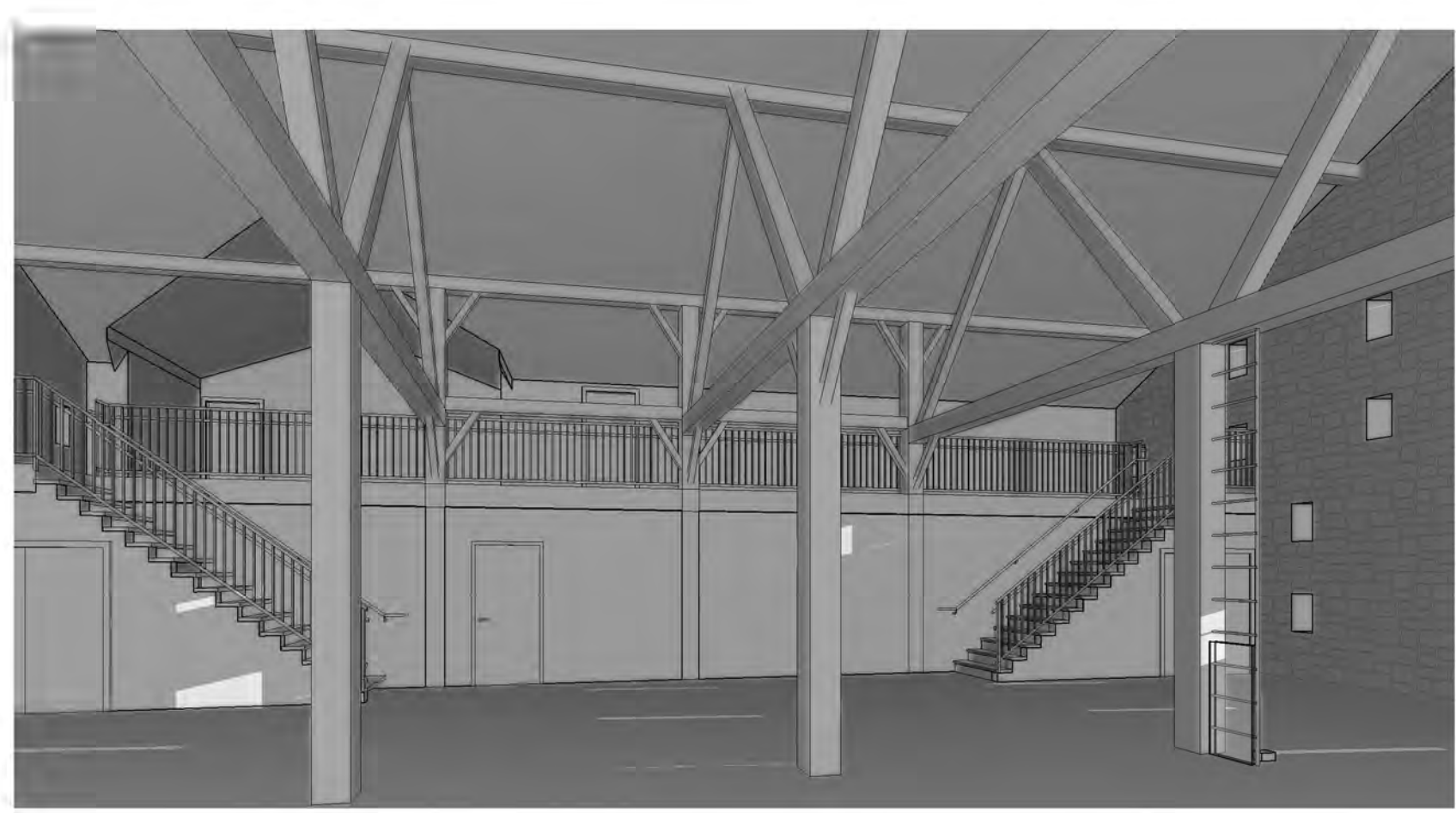

5 Interior View from Front Entrance
A4.0

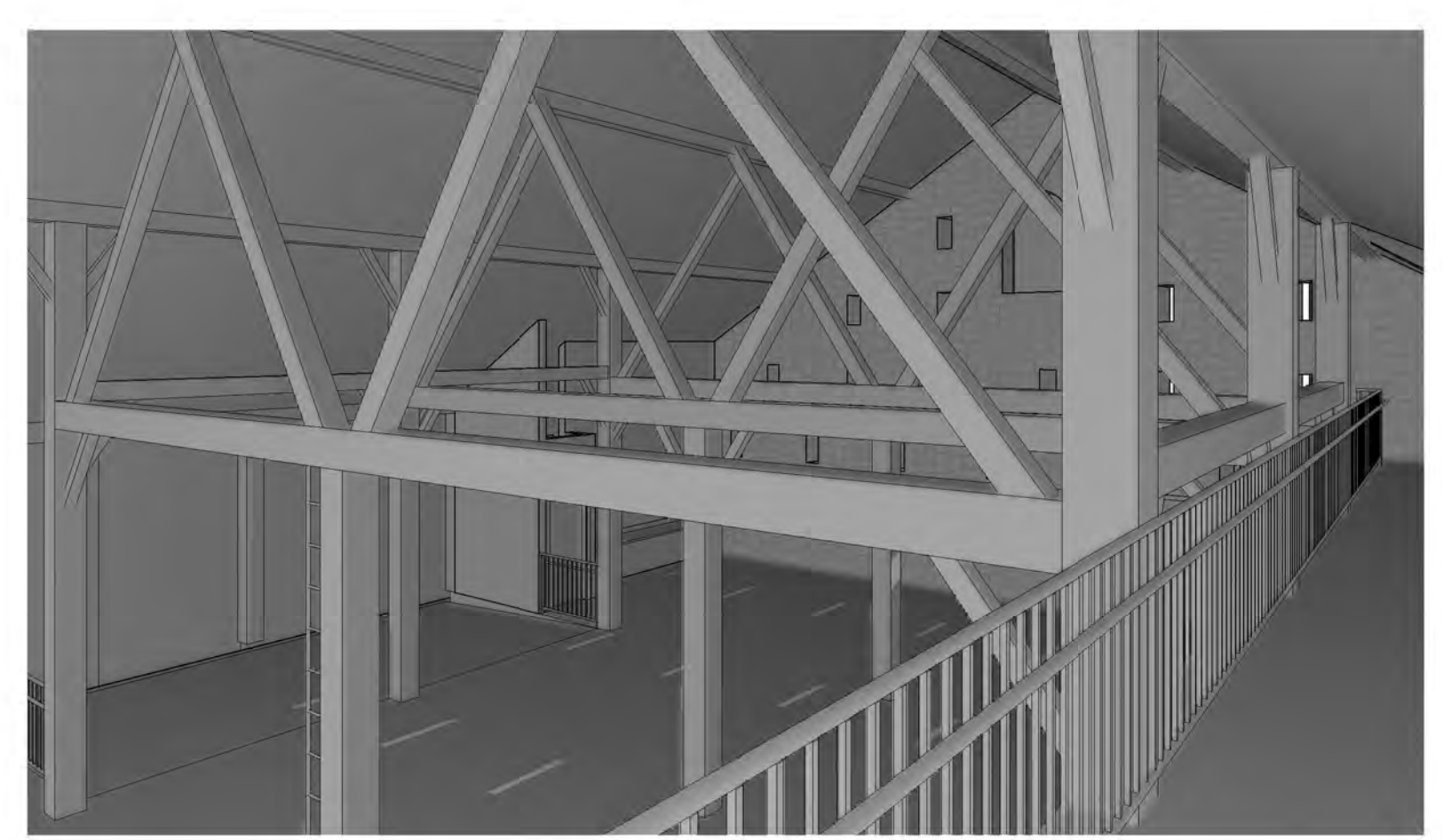

6 Interior View from Gallery
A4.0



7 Interior View from Front Entrance - Looking East
A4.0

2020-11-16 4:06:30 PM

REVISIONS _____ DATE _____

THE CONTRACTOR SHALL VERIFY ALL DIMENSIONS IN THE COURSE OF CONSTRUCTION AND REPORT TO THE ARCHITECT PRIOR TO THE COMMENCEMENT OF THE WORK. UNDER NO CIRCUMSTANCES SHALL THE CONTRACTOR PROCEED IN UNCERTAINTY.
ALL DRAWINGS AND SPECIFICATIONS PREPARED BY THE ARCHITECT TO BE RETURNED AT HIS REQUEST TO BE RETURNED AT HIS REQUEST. DO NOT SCALE DRAWINGS.
© COPYRIGHT

SEAL

PROJECT NORTH

Event Barn
7450 Middlebrooke Rd. Elora
Building Elevations

STATUS	Preliminary
PROJECT #	20037
CHKD	Checker
DRAWN	Author
SCALE	1:100
DATE DWN	20200723
ISSUED	20200904

2021-03-31 11:41:25 AM

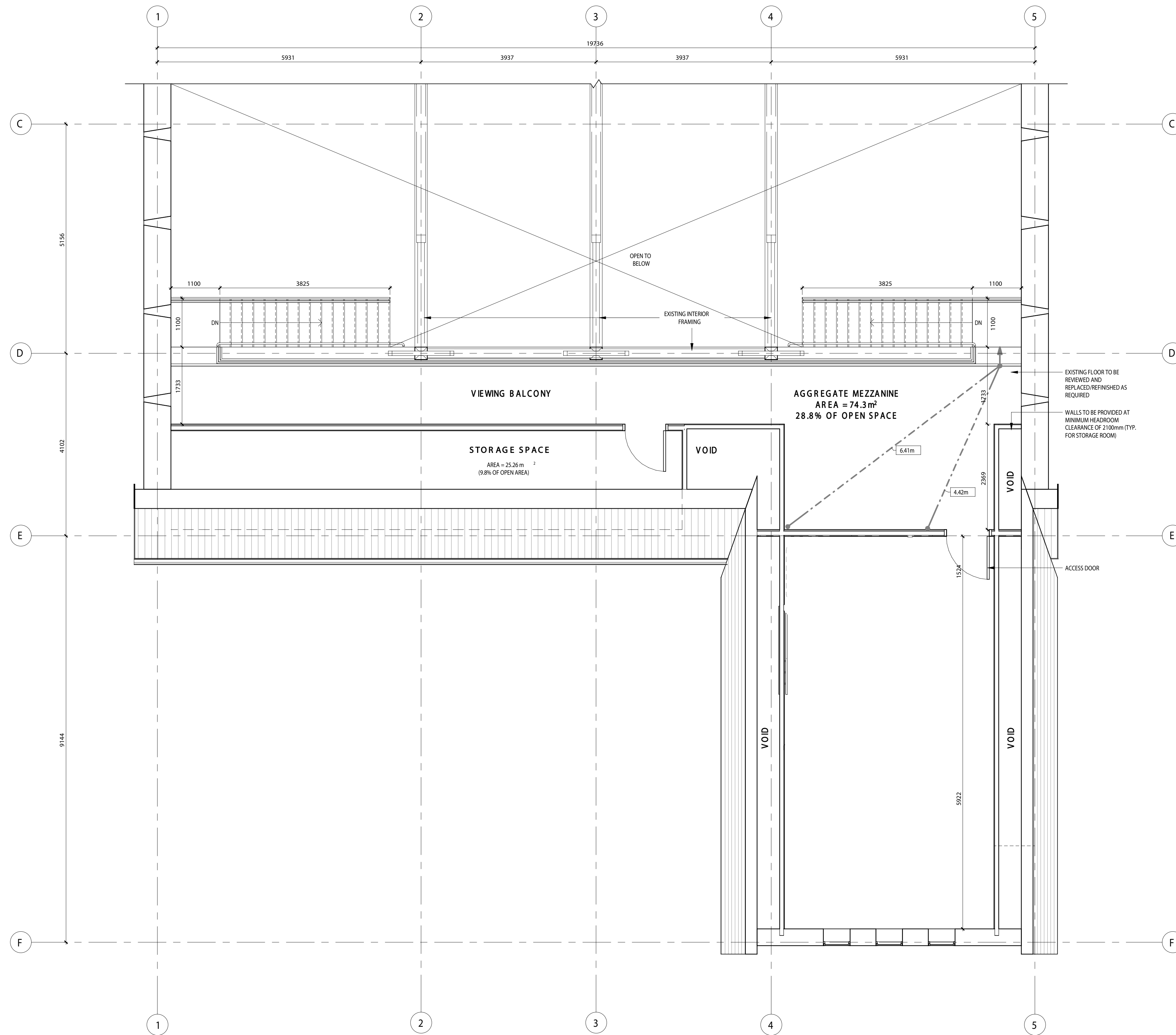

1 002 Level 2
A2.2 1:50

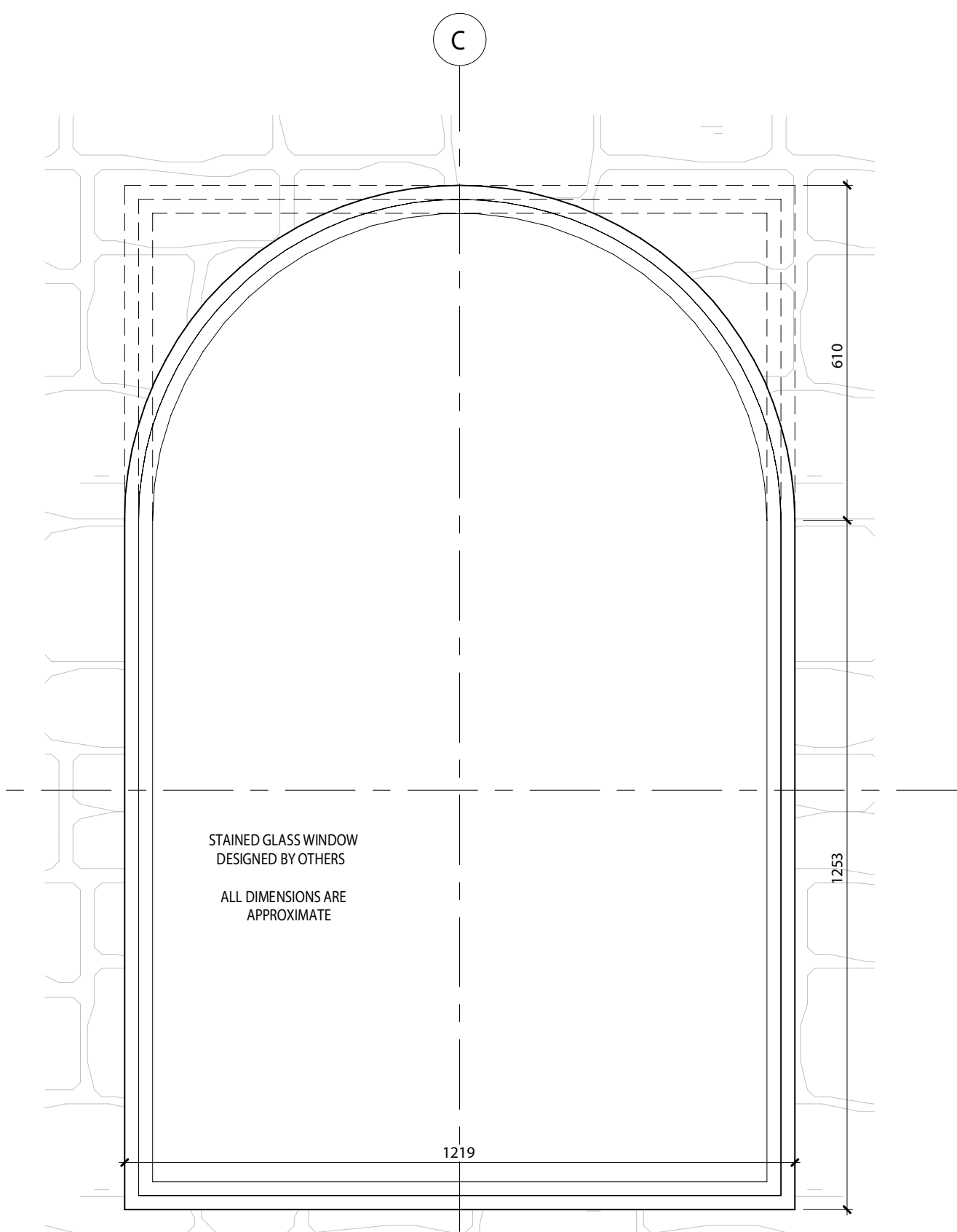

4 Stained Glass Window Detail
A2.2 1:10

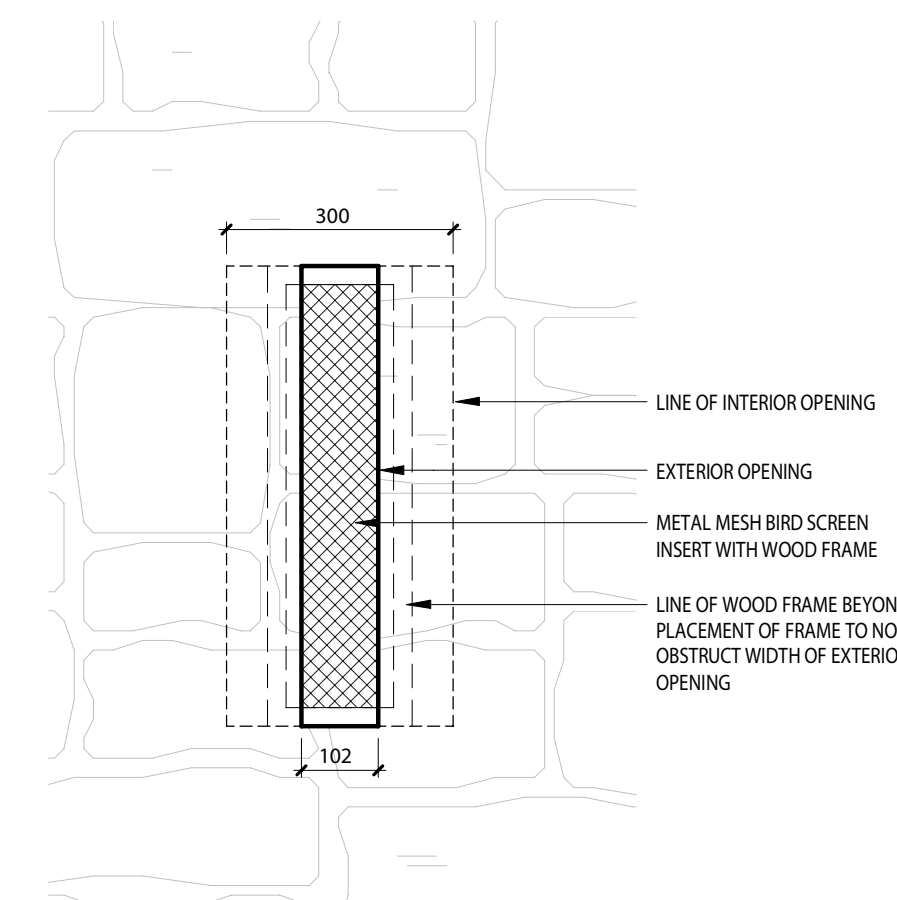

3 Tapered Window Elevation Detail
A2.2 1:10

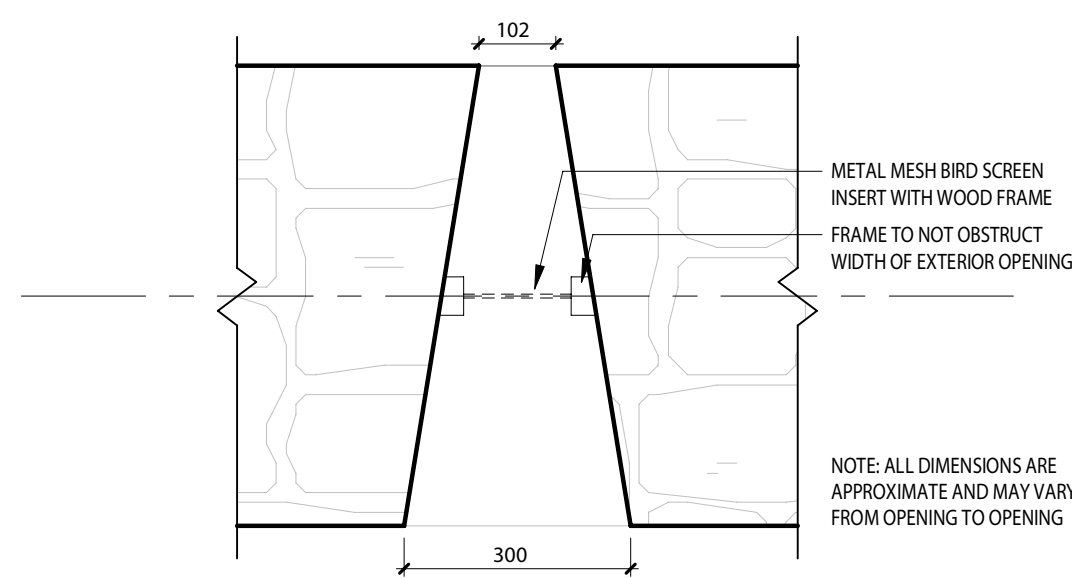

2 Tapered Window Plan Detail
A2.2 1:10

REVISIONS	DATE

THE CONTRACTOR SHALL VERIFY ALL DIMENSIONS IN THE COURSE OF CONSTRUCTION AND REPORT ANY DISCREPANCIES TO THE ARCHITECT PRIOR TO THE COMMENCEMENT OF THE WORK. UNDER NO CIRCUMSTANCES SHALL THE CONTRACTOR PROCEED IN UNCERTAINTY.
ALL DRAWINGS AND SPECIFICATIONS PREPARED BY THE ARCHITECT SHALL BE CONSIDERED AS THE BASIS FOR THE CONTRACT AND ARE TO BE RETURNED AT HIS REQUEST.
© COPYRIGHT
DON'T SCALE DRAWINGS.

SEAL

PROJECT NORTH

Middlebrook Barn
7450 Middlebrooke Rd. Elora
2nd Floor Plan

STATUS	Repair Permit
PROJECT #	20037
CHKD	Checker
DRAWN	Author
SCALE	As Indicated
DATE DWN	20200723
ISSUED	20200904
SHEET #	

Appendix C –Tacoma Condition Assessment Report

7450 Middlebrook Road Barn Condition Assessment

7450 Middlebrook Road
Elora, Ontario



Prepared by:



176 Speedvale Avenue West
Guelph, ON
TE-34810-19

September 23, 2019

1. Introduction

Tacoma Engineers has been retained by Melinda Croft to provide a structural assessment on an existing barn located at 7450 Middlebrook Road in Elora, Ontario. The property has been recently purchased by the client. This assessment is being performed to identify areas of deterioration on the structure and to inform maintenance planning for the barn. The potential adaptive reuse of the structure is also under consideration; therefore, this report also presents considerations for the next steps in this process.

2. Background

This assessment is being undertaken by the future Owner, and is intended to form maintenance plans for the building. This report is not being prepared as a response to an Order, recommendations, or request by any regulatory body. No previous work has been completed by Tacoma Engineers on this building for this or any other owner. No sub-consultants have been retained to participate in this assessment.

This report is based on a visual inspection only and does not include any destructive testing. Where no concerns were noted the structure is assumed to be performing adequately. The structure is assumed to have been constructed in accordance with best building practices common at the time of construction. No further structural analysis or building code analysis has been carried out as part of this report unless specifically noted.

The undersigned attended the site on September 16, 2019, accompanied by Melinda Croft and Melissa Seagrove (realtor).

3. Definitions

The following is a summary of definitions of terms used in this report describing the condition of the structure as well as recommended remedial actions. Detailed material condition definitions are included in Appendix A of this report.

- **Condition States¹:**
 1. Excellent – Element(s) in “new” condition. No visible deterioration type defects present, and remedial action is not required.
 2. Good – Element(s) where the first signs of minor defects are visible. These types of defects would not normally trigger remedial action since the overall performance is not affected.
 3. Fair – Element(s) where medium defects are visible. These types of defects may trigger a “preventative maintenance” type of remedial action where it is economical to do so.
 4. Poor – Element(s) where severe or very severe defects are visible. These types of defects would normally trigger rehabilitation or replacement if the extent and location affect the overall performance of that element.
- **Immediate remedial action¹:** these are items that present an immediate structural and/or safety hazards (falling objects, tripping hazards, full or partial collapse, etc.). The remedial recommendations will need to be implemented immediately and may include restricting access, temporary shoring/supports or removing the hazard.

¹ Adapted from “Structural Condition Assessment”, 2005, American Society of Civil Engineers/Structural Engineering Institute

- **Priority remedial action¹:** these are items that do not present an immediate hazard but still require action in an expedited manner. The postponement of these items will likely result in the further degradation of the structural systems and finishes. This may include interim repairs, further investigations, etc. and are broken down into timelines as follows:
 1. **Short-term:** it is recommended that items listed as short-term remedial action are acted on within the next 12 months.
 2. **Medium-term:** it is recommended that items listed as medium-term remedial action are acted on within the next 24 months.
 3. **Long-term:** it is recommended that items listed as long-term remedial action are acted on within the next 5-10 years. Many of these items include recommendations of further review/investigation.
- **Routine maintenance¹:** these are items that can be performed as part of a regularly scheduled maintenance program.

4. General Structural Conditions

The existing barn can be separated into two distinct sections, the original barn and a more modern addition. For the purpose of this assessment, the original barn was the main focus. The original barn is a traditional southern Ontario style bank-barn with local field stone exterior mass masonry walls and a wood framed gable roof. Traditional timber frames form the interior roof structure of the barn. The main floor framing of the barn is comprised of hand-hewn timber beams. The exact construction date was not available at the time of the assessment but based on its framing it is expected that the barn was built approximately 100 years ago. A more modern wood framed addition was added to the South-East of the barn; however, records of these renovations and framing changes were not available at the time of the assessment.

At the time of the site visit the original barn was essentially unoccupied besides a few small pieces of equipment in the basement and riding lawnmower on the main floor. The barn addition was occupied with a small wood shop on the main floor (no heavy equipment on site at the time of the visit) and hay storage in the attic.

4.1. Original Barn

The mass masonry barn located at 7450 Middlebrook Road is a one storey structure with an approximate footprint of 60' by 60'. It has an accessible basement including several pens on the low soil side of the structure. The roof of the barn is wood framed with interior hand-hewn heavy timber frames and hand-hewn heavy timber main floor framing. The foundation walls of the barn are rubble stone.

The rubble stone foundation walls are in good to fair condition with localized areas of mortar deterioration. The mortar deterioration is generally more concentrated to the base of the wall and corners as can be seen in Figure 1a and 1b below.



Figure 1a,b: Mortar deterioration of foundation walls

Mortar deterioration was also present on the exterior faces of the mass masonry walls as can be seen in Figure 2 below.



Figure 2: Mortar deterioration on exterior face of gable end wall

This deterioration was most prominent on the South-West gable end wall. Repointing or deep repointing with a compatible lime based in these areas is recommended to support the long-term performance of the structure.

Some of the main floor joists were deteriorated at the time of the site visit as can be seen in Figure 3 below.



Figure 3: Joist deterioration in main floor framing

It is suspected that this damage is insect related; however, it is unclear if the insect damage is active. Some joists bearing on the exterior foundation walls were also deteriorated, likely due to increased moisture exposure at grade. It is recommended that the deteriorated joists be replaced or reinforced to maintain the original design capacity of the main floor framing. It is also recommended that the framing be incrementally monitored to ensure the insect related damage does not progress.

Deterioration and cracking were noted in some locations on interior faces of the mass masonry walls as can be seen in Figure 4a and 4b.



Figure 4: Cracking around openings on masonry walls

It appears that some of these cracks have been previously repaired using cement-based mortar. Cement based mortar is an incompatible mortar for these walls given its high compressive strength relative to the wall and impermeability to moisture, which can lead to accelerated deterioration in the existing

masonry. It is suspected that this cracking is a result of prolonged moisture exposure at the wall openings or possible shrinkage of the mass masonry walls. Both causes are common in walls of this type of construction and age. It is recommended that the cracking be repointed with compatible lime-based mortar to promote the long-term performance of the structure.

4.2. Barn Addition

The wood framed barn addition at 7450 Middlebrook Road is a two-storey structure with an approximate footprint of 22' by 29'. It is constructed with dimensional wood framed floors and a wood framed gambrel roof. It has a walk-out style basement constructed of board formed concrete foundations walls.

Deterioration was noted at the basement window locations in the addition an example of which can be seen in Figure 6 below.

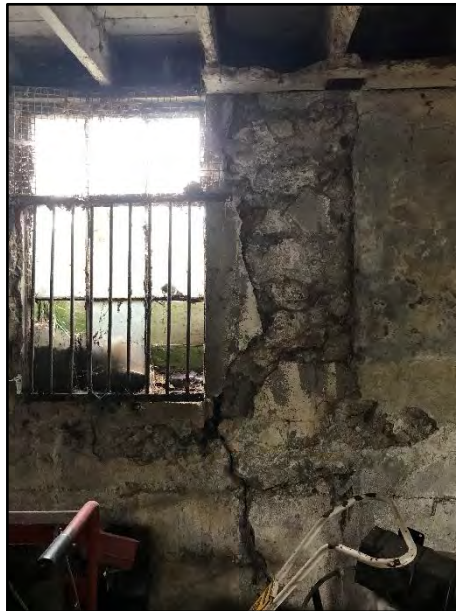

Figure 5: Foundation wall deterioration

This deterioration is likely the result of prolonged moisture exposure at the windows. It is recommended that these areas be repaired with a suitable concrete repair product and that drainage around the building be monitored and repaired as required to ensure water ingress is not occurring at these openings.

5. Summary of Recommendations

The following provides a summary of the recommendations for the existing structure.

Items requiring short-term (next 12 months) remedial action:

1. Repointing of the exterior masonry walls of the original barn with compatible lime-based mortar
2. Repair of deterioration below windows in the barn addition with suitable concrete repair product

Items requiring medium-term (next 24 months or prior to occupying the space beyond current occupancy) remedial action:

1. Replacement or reinforcement of deteriorated joists in the original barn. Tacoma Engineers did not perform a detailed structural capacity analysis of the floor system as part of this investigation.

Items requiring routine maintenance:

1. Monitoring of drainage systems (and repair as required) for the barn and barn addition.
2. Monitoring of floor joists to ensure insect damage is not active.

6. Adaptive Reuse of the Structure

The adaptive reuse of this structure is currently under consideration. At present, this barn is an active agricultural property. Changing the use from an agricultural occupancy to an assembly occupancy (event space) would require the following, from a structural perspective:

- A detailed analysis of the floor framing and reinforcing to suit the new loading (as required).
- A lateral analysis, including seismic analysis, of the structure. It is likely that some bracing will need to be introduced to ensure that the lateral bracing system meets current building code requirements.

It is recommended that the zoning changes be addressed first with the Township of Centre Wellington and that an architect be retained to begin looking at the life safety requirements of this change of use prior to undertaking a full structural analysis.

7. Conclusions

In general, the original barn and barn addition are in good to fair condition with localized areas of deterioration. It is expected that most of the deterioration is related to long-term moisture exposure; therefore, monitoring drainage and preventing active water ingress will minimize future deterioration to the structure. The structure is a candidate for adaptive reuse for an event space; however, further analysis to confirm the structural adequacy and bracing requirements will be required.

Please contact the undersigned with any further questions or comments.

Per:

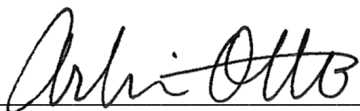
Arlin Otto, EIT, CAHP Intern
Structural Designer
Tacoma Engineers Inc.

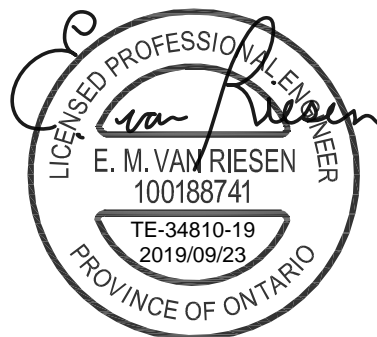

Appendix D – Scoped HIA Terms of Reference



Centre Wellington

Lighting

- At time of site plan application lighting details to be confirmed, including all public access and parking areas. All lighting to be dark sky compliant. Full photometric details need to be provided at time of site plan application, including light spillover onto adjacent properties.

Road Access

- Any alteration proposed to road entrance (widening, culverts, etc.) requires permit from Infrastructure Services

Signage

- Any proposed signage must conform to Sign By-law 2013-004 (<https://www.centrewellington.ca/en/township-services/resources/Documents/LegislativeServices/13-004.pdf>) or requires sign variance approval

The following studies and further information will be required in support of a rezoning application at the time of submission:

Planning Justification Report

- To address compliance and/or conformity with all applicable policies of the Provincial Policy Statement 2020, Provincial Growth Plan (A Place to Grow), Guidelines on Permitted Uses in Ontario's Prime Agricultural Areas (Publication 851), County Official Plan, and Minimum Distance Separation requirements
- To address potential land use impacts as a result of the proposed use(s) in terms of noise and traffic
- To provide rationale and justification for such use in the Prime Agricultural area, with specific restrictions to ensure policies can be met
- Further details required regarding specific uses proposed, including parameters for each use (size, scale, capacity, frequency, etc.) to determine compliance with applicable policies and restrictive measures necessary
- County to comment on policy framework and additional application requirements

Heritage Impact Assessment (Scoped)

- To review heritage values/attributes and address potential impacts on the heritage resource(s), specifically including the historic barn on the property, as a result of any proposed physical changes to the building(s) and/or landscape
- A conservation plan (memo) should be prepared to ensure short and long term conservation objectives are achieved for identified heritage resources and their attributes

Appendix E—Curriculum Vitae



CURRICULUM VITAE

EDUCATION

2006

Masters of Arts (Planning)
University of Waterloo

1998

Bachelor of Environmental Studies
University of Waterloo

1998

Bachelor of Arts (Art History)
University of Saskatchewan

Dan Currie, MA, MCIP, RPP, CAHP

Dan Currie, a Partner and Managing Director of MHBC's Cultural Heritage Division, joined MHBC Planning in 2009, after having worked in various positions in the public sector since 1997. Dan provides a variety of planning services for public and private sector clients including a wide range of cultural heritage policy and planning work including strategic planning, heritage policy, heritage conservation district studies and plans, heritage master plans, cultural heritage evaluations, heritage impact assessments and cultural heritage landscape studies.

PROFESSIONAL ASSOCIATIONS

Full Member, Canadian Institute of Planners

Full Member, Ontario Professional Planners Institute

Professional Member, Canadian Association of Heritage Professionals

SELECTED PROJECT EXPERIENCE

Heritage Conservation District Studies and Plans

Stouffville Heritage Conservation District Study
Alton Heritage Conservation District Study, Caledon
Port Stanley Heritage Conservation District Plan
Port Credit Heritage Conservation District Plan, Mississauga
Town of Cobourg Heritage Conservation District Plan updates
Rondeau Heritage Conservation District Study & Plan, Chatham Kent,
Barriefield Heritage Conservation District Plan Update, Kingston
Victoria Square Heritage Conservation District Study, Markham
Bala Heritage Conservation District Study and Plan, Township of Muskoka Lakes
Downtown Meaford Heritage Conservation District Study and Plan
Brooklyn and College Hill Heritage Conservation District Plan, Guelph
Garden District Heritage Conservation District Study and Plan, Toronto

Heritage Master Plans and Management Plans

Town of Aurora Municipal Heritage Register Update
City of Guelph Cultural Heritage Action Plan
Town of Cobourg Heritage Master Plan
Burlington Heights Heritage Lands Management Plan
City of London Western Counties Cultural Heritage Plan

CONTACT

540 Bingemans Centre Drive,
Suite 200
Kitchener, ON N2B 3X9
T 519 576 3650 x 744
F 519 576 0121
dcurrie@mhbcplan.com
www.mhbcplan.com

CURRICULUM VITAE

Dan Currie, MA, MCIP, RPP, CAHP

Cultural Heritage Evaluations

Morningstar Mill, St Catherines
MacDonald Mowatt House, University of Toronto
City of Kitchener Heritage Property Inventory Update
Niagara Parks Commission Queen Victoria Park Cultural Heritage Evaluation
Designation of Main Street Presbyterian Church, Town of Erin
Designation of St Johns Anglican Church, Norwich
Cultural Heritage Landscape evaluation, former Burlingham Farmstead, Prince Edward County

Heritage Impact Assessments

Heritage Impact Assessment for Pier 8, Hamilton
Homer Watson House Heritage Impact Assessment, Kitchener
Expansion of Schneider Haus National Historic Site, Kitchener
Redevelopment of former industrial facility, 57 Lakeport Road, Port Dalhousie
Redevelopment of former amusement park, Boblo Island
Redevelopment of historic Waterloo Post Office
Redevelopment of former Brick Brewery, Waterloo
Redevelopment of former American Standard factory, Cambridge
Redevelopment of former Goldie and McCullough factory, Cambridge
Mount Pleasant Islamic Centre, Brampton
Demolition of former farmhouse at 10536 McCowan Road, Markham

Heritage Assessments for Infrastructure Projects and Environmental Assessments

Heritage Assessment of 10 Bridges within Rockcliffe Special Policy Area, Toronto
Blenheim Road Realignment Collector Road EA, Cambridge
Badley Bridge EA, Elora
Black Bridge Road EA, Cambridge
Heritage and Cultural Heritage Landscape Assessment of Twenty Mile Creek Arch Bridge, Town of Lincoln
Heritage Evaluation of Deer River, Burnt Dam and MacIntosh Bridges, Peterborough County

Conservation Plans

Black Bridge Strategic Conservation Plan, Cambridge
Conservation Plan for Log house, Beurgetz Ave, Kitchener
Conservation and Construction Protection Plan - 54 Margaret Avenue, Kitchener

CONTACT

540 Bingham Centre Drive,
Suite 200
Kitchener, ON N2B 3X9
T 519 576 3650 x 744
F 519 576 0121
dcurrie@mhbcpplan.com
www.mhbcpplan.com

CURRICULUMVITAE

Dan Currie, MA, MCIP, RPP, CAHP

Tribunal Hearings:

Redevelopment of 217 King Street, Waterloo (OLT)
Redevelopment of 12 Pearl Street, Burlington (OLT)
Designation of 30 Ontario Street, St Catharines (CRB)
Designation of 27 Prideaux Street, Niagara on the Lake (CRB)
Redevelopment of Langmaids Island, Lake of Bays (LPAT)
Port Credit Heritage Conservation District (LPAT)
Demolition 174 St Paul Street (Collingwood Heritage District) (LPAT)
Brooklyn and College Hill HCD Plan (OMB)
Rondeau HCD Plan (LPAT)
Designation of 108 Moore Street, Bradford (CRB)
Redevelopment of property at 64 Grand Ave, Cambridge (LPAT)
Youngblood subdivision, Elora (LPAT)
Downtown Meaford HCD Plan (OMB)
Designation of St Johns Church, Norwich (CRB - underway)

LAND USE PLANNING

Provide consulting services for municipal and private sector clients for:

- Secondary Plans
- Draft plans of subdivision
- Consent
- Official Plan Amendment
- Zoning By-law Amendment
- Minor Variance
- Site Plan

CONTACT

540 Bingemans Centre Drive,
Suite 200
Kitchener, ON N2B 3X9
T 519 576 3650 x 744
F 519 576 0121
dcurrie@mhbcplan.com
www.mhbcplan.com



CURRICULUM VITAE

Rachel Redshaw, MA, H.E. Dipl., CAHP

EDUCATION

2011
Higher Education Diploma
Cultural Development/ Gaelic Studies
Sabhal Mòr Ostaig, University of the Highlands and Islands

2012
Bachelor of Arts
Joint Advanced Major in Celtic Studies and Anthropology
Saint Francis Xavier University

2014
Master of Arts
World Heritage and Cultural Projects for Development
The International Training Centre of the ILO in partnership with the University of Turin, Politecnico di Torino, University of Paris 1 Pantheon-Sorbonne, UNESCO, ICCROM, Macquarie University

www.linkedin.com/in/rachelredshaw

Rachel Redshaw, a Senior Heritage Planner with MHBC, joined the firm in 2018. Ms. Redshaw has a Bachelor of Arts in Anthropology and Celtic Studies and a Master of Arts in World Heritage and Cultural Projects for Development. Ms. Redshaw completed her Master's in Turin, Italy; the Master's program was established by UNESCO in conjunction with the University of Turin and the International Training Centre of the ILO. Rachel is professional member of the Canadian Association of Heritage Professionals (CAHP).

Ms. Redshaw provides a variety of heritage planning services for public and private sector clients. Ms. Redshaw has worked for years completing cultural heritage planning in a municipal setting. She has worked in municipal building and planning departments and for the private sector to gain a diverse knowledge of building and planning in respect to how they apply to cultural heritage. Rachel enjoys being involved in the local community and has been involved in the collection of oral history, in English and Gaelic, and local records for their protection and conservation and occasionally lecturers on related topics. Her passion for history and experience in archives, museums, municipal building and planning departments supports her ability to provide exceptional cultural heritage services.

PROFESSIONAL ASSOCIATIONS

Professional Member, Canadian Association of Heritage Professionals (CAHP)

PROFESSIONAL HISTORY

2022 - Present Senior Heritage Planner,
MacNaughton Hermsen Britton Clarkson Planning Limited

2018 - 2022 Heritage Planner,
MacNaughton Hermsen Britton Clarkson Planning Limited

2018 Building Permit Coordinator, (Contract)
Township of Wellesley

2018 Building Permit Coordinator (Contract)

CONTACT

540 Bingemans Centre Drive,
Suite 200
Kitchener, ON N2B 3X9
T 519 576 3650 x751
F 519 576 0121
rredshaw@mhbcpplan.com
www.mhbcpplan.com



CURRICULUM VITAE

Rachel Redshaw, MA, H.E. Dipl., CAHP

RSM Building Consultants

- 2017 Deputy Clerk,
Township of North Dumfries
- 2015-2016 Building/ Planning Clerk
Township of North Dumfries
- 2009-2014 Historical Researcher & Planner
Township of North Dumfries
- 2012 Translator, Archives of Ontario
- 2012 Cultural Heritage Events Facilitator (Reminiscence Journey) and
Executive Assistant, Waterloo Region Plowing Match and Rural
Expo
- 2011 Curatorial Research Assistant
Highland Village Museum/ Baile nan Gàidheal

PROFESSIONAL/COMMUNITY ASSOCIATIONS

- 2022-Present Professional Member, Canadian Association of Heritage
Professionals
- 2017-2020 Member, AMCTO
- 2018-2019 Member of Publications Committee, Waterloo Historical Society
- 2018 Member, Architectural Conservancy of Ontario- Cambridge
- 2018 - 2019 Secretary, Toronto Gaelic Society
- 2012 -2017 Member (Former Co-Chair & Co-Founder), North Dumfries
Historical Preservation Society
- 2011 - 2014 Member, North Dumfries Municipal Heritage Committee
- 2013 Greenfield Heritage Conservation District, Sub-committee,
Doors Open Waterloo Region
- 2012 Volunteer Historical Interpreter, Doon Heritage Village, Ken
Seiling Waterloo Region Museum
- 2008-2012 Member, Celtic Collections, Angus L. Macdonald Library
- 2012-2013 Member (Public Relations), Mill Race Folk Society

CONTACT

540 Bingham Centre Drive,
Suite 200
Kitchener, ON N2B 3X9
T 519 576 3650 x751
F 519 576 0121
redshaw@mhbcpplan.com
www.mhbcpplan.com



CURRICULUM VITAE

Rachel Redshaw, MA, H.E. Dipl., CAHP

- 2011 Member, University of Waterloo Sub-steering Committee for HCD Study, Village of Ayr, North Dumfries
- 2010-2011 Member (volunteer archivist), Antigonish Heritage Museum

AWARDS / PUBLICATIONS / RECOGNITION

- 2019 Waterloo Historical Society Publication, *Old Shaw: The Story of a Kindly Waterloo County Roamer*
- 2014 Master's Dissertation, *The Rise of the City: Social Business Incubation in the City of Hamilton*
- 2014 Lecture, *A Scot's Nirvana*, Homer Watson House and Gallery
- 2013 Lecture, *The Virtual Voice of the Past: The Use of Online Oral Accounts for a Holistic Understanding of History*, University of Guelph Spring Colloquium
- 2012-2013 Gaelic Events Facilitator, University of Guelph
- 2012-2015 Intermediate Gaelic Facilitator, St. Michael's College, University of Toronto
- 2012 *Nach eil ann tuilleadh: An Nòs Ùr aig nan Gàidheal* (BA Thesis)
Thesis written in Scottish Gaelic evaluating disappearing Gaelic rites of passage in Nova Scotia.
- 2012 Waterloo Historical Society Publication, *Harvesting Bees and Feasting Tables: Fit for the Men, Women and Children of Dickie Settlement and Area, Township of North Dumfries*
- 2007-2012 25 historical publications in the Ayr News (access to some articles <http://ayrnews.ca/recent>)

PROFESSIONAL DEVELOPMENT COURSES

- 2021 Certificate for Indigenous Relations Training Program with University of Calgary
- 2020 Condo Director Training Certificate (CAO)
- 2018 Building Officials and the Law (OBOA Course)
- 2017-2018 AMCTO Training (MAP 1)
- 2017 AODA Training

CONTACT

540 Bingham Centre Drive,
Suite 200
Kitchener, ON N2B 3X9
T 519 576 3650 x751
F 519 576 0121
rredshaw@mhbcpplan.com
www.mhbcpplan.com



CURRICULUM VITAE

Rachel Redshaw, MA, H.E. Dipl., CAHP

2010

Irish Archaeological Field School Certificate

COMPUTER SKILLS

- Microsoft Word Office
- Bluebeam Revu 2017
- ArcGIS
- Keystone (PRINSYS)
- Municipal Connect
- Adobe Photoshop
- Illustrator
- ABBYY Fine Reader 11
- Book Drive

SELECT PROJECT EXPERIENCE 2018-2022

CULTURAL HERITAGE IMPACT ASSESSMENTS

- Promenade at Clifton Hill, Niagara Falls (Niagara Parks Commission)
- 16-20 Queen Street North, Kitchener (Former Economical Insurance Building)
- Peterborough Lift Lock and Trent-Severn Waterway (TSW), National Historic Sites, Development for 380 Armour Road, City of Peterborough
- Middlesex County Court House, National Historic Site, for development at 50 King Street
- McDougall Cottage and National Historic Site, for development at 93 Grand Avenue South, City of Kitchener
- City of Waterloo Former Post Office, Development for 35-41 King Street North, City of Waterloo, Phase II
- Consumers' Gas Station B, Development for 450 Eastern Avenue, City of Toronto
- 82 Weber Street and 87 Scott Street, City of Kitchener
- 39 Wellington Street West, City of Brampton

CONTACT

540 Bingham Centre Drive,
Suite 200
Kitchener, ON N2B 3X9
T 519 576 3650 x751
F 519 576 0121
redshaw@mhbcpplan.com
www.mhbcpplan.com



CURRICULUM VITAE

Rachel Redshaw, MA, H.E. Dipl., CAHP

- 543 Ridout Street North, City of London
- 34 Manley Street, Village of Ayr, Township of North Dumfries
- Quinte's Isle Campark, 558 Welbanks Road, Prince Edward County (OLT)
- 174 St. Paul Street, Town of Collingwood (OLT)
- 45 Duke Street, City of Kitchener
- 383-385 Pearl Street, City of Burlington
- St. Patrick's Catholic Elementary School, (SPCES), 20 East Avenue South, City of Hamilton
- 250 Allendale Road, City of Cambridge
- 249 Clarence Street, City of Vaughan

Specific for Relocation of Heritage Buildings

- 1395 Main Street, City of Kitchener
- 10379 & 10411 Kennedy Road, City of Markham

CULTURAL HERITAGE SCREENING REPORT

Kelso Conservation Area, Halton County
5th Side Road, County Road 53, Simcoe County
Waterdown Trunk Watermain Twinning Project, City of Hamilton

CULTURAL HERITAGE EVALUATION REPORTS

- 52 King Street North, City of Kitchener
- Sarnia Collegiate Institute and Technical School (SCITS), 275 Wellington, City of Sarnia (Municipal contingency study)
- 10536 McCowan Road, City of Markham
- Former Burns Presbyterian Church, 155 Main Street, Town of Erin (Designation Report)
- Former St. Paul's Anglican Church, 23 Dover Street, Town of Otterville, Norwich Township (OLT)
- 6170 Fallsview Boulevard, City of Niagara Falls

CONSERVATION PLANS

- City of Waterloo Former Post Office, 35-41 King Street North, City of Waterloo
- 82 Weber Street East, City of Kitchener
- 87 Scott Street, City of Kitchener
- 107 Young Street, City of Kitchener

CONTACT

540 Bingham Centre Drive,
Suite 200
Kitchener, ON N2B 3X9
T 519 576 3650 x751
F 519 576 0121
redshaw@mhbcpplan.com
www.mhbcpplan.com



CURRICULUM VITAE

Rachel Redshaw, MA, H.E. Dipl., CAHP

- 1395 Main Street, City of Kitchener
- 10379 & 10411 Kennedy Road, City of Markham

Cultural Heritage Conservation Protection Plans (Temporary protection for heritage building during construction)

- 16-20 Queen Street North, Kitchener (included Stabilization, Demolition and Risk Management Plan)
- 12 & 54 Margaret Avenue, City of Kitchener
- 45 Duke Street, City of Kitchener
- 82 Weber Street West and 87 Scott Street, City of Kitchener
- 660 Sunningdale Road, London

DOCUMENTATION AND SALVAGE REPORTS

- 16-20 Queen Street North, City of Kitchener
- 57 Lakeport Road City of St. Catharines
- Gaslight District, 64 Grand Avenue South, City of Cambridge
- 242-262 Queen Street South, City of Kitchener
- 721 Franklin Boulevard, City of Cambridge

HERITAGE PERMIT APPLICATIONS

- 16-20 Queen Street North, Kitchener
- 50 King Street, London
- 35-41 King Street North, City of Waterloo (Old Post Office), Phase II (alteration to building with a municipal heritage easement, Section 37, OHA)
- 50-56 Weber Street West & 107 Young Street, City of Kitchener (demolition and new construction within HCD)
- 30-40 Margaret Avenue, City of Kitchener (new construction within HCD)
- 249 Clarence Street, City of Vaughan (alteration within HCD)
- 174 St. Paul Street, Town of Collingwood (demolition within HCD)

HERITAGE CONSERVATION DISTRICTS/ MASTER PLANS/ HERITAGE CHARACTER STUDY

- Elgin, Central and Memorial Neighbourhoods, Municipality of Clarington
- Stouffville Heritage Conservation District Study (Project Lead 2021-2022)
- Town of Aurora Heritage Register Update

CONTACT

540 Bingham Centre Drive,
Suite 200
Kitchener, ON N2B 3X9
T 519 576 3650 x751
F 519 576 0121
redshaw@mhbcpplan.com
www.mhbcpplan.com



CURRICULUM VITAE

Robyn McIntyre, BES

EDUCATION

2022

Bachelor of Environmental Studies
Honours Planning (Co-op)
University of Waterloo
Specialization: Land Development
Specialization: Urban Design

Robyn McIntyre formally joined MHBC as a Planner in 2022. Before joining the MHBC team, Robyn completed co-op placements with the Town of Bracebridge (2019), Borden Ladner Gervais LLP (2020), the County of Bruce (2020), and MHBC's Kitchener office (2021). Through these placements, Robyn focused on land development, municipal planning, tribunal hearings, and heritage planning.

At MHBC, Robyn works with both private and public sector clients on a variety of project. She completes research & compiles due diligence reports, reviews & applies policy, writes planning justification reports/urban design briefs, and prepares development applications among other responsibilities. Additionally, Robyn has experience preparing appeal documents for the Local Planning Appeal Tribunal (now Ontario Land Tribunal) and the Toronto Local Appeal Body.

Robyn is working towards becoming a full member of the Ontario Professional Planners Institute (OPPI) and Canadian Institute of Planners (CIP). She is currently completing her candidacy for her Registered Professional Planner Designation in Ontario.

PROFESSIONAL HISTORY

- 2022 – Present Planner
MacNaughton Hermsen Britton Clarkson Planning Ltd.
- 2021 – 2022 Student Planner (Co-op)
MacNaughton Hermsen Britton Clarkson Planning Ltd
- 2020 – 2020 Planning Student (Co-op)
The Corporation of the County of Bruce
- 2020 - 2020 Student Planner (Co-op)
Borden Ladner Gervais LLP
- 2018 - 2019 Planning Student (Co-op)
The Corporation of the Town of Bracebridge

CONTACT

540 Bingham Centre Drive,
Suite 200
Kitchener, ON N2B 3X9
T 519 576 3650 x737
F 519 576 0121
smirtitsch@mhbcplan.com
www.mhbcplan.com

CURRICULUM **VITAE**

Robyn McIntyre, BES

SELECTED PROJECT EXPERIENCE

Research, analysis, and preparation of submission materials (reports, studies, applications, etc.) for municipal land development projects.

Receive, process, and make recommendations on municipal land development applications while supporting municipal clients.

Field work, research, and report preparation for various heritage projects (Cultural Heritage Evaluation Reports, Heritage Impact Assessments, and Heritage Conservation District Studies) under Parts IV and V of the *Ontario Heritage Act*.

Submission and receipt of development applications under the Planning Act (Minor Variances, Zoning Bylaw Amendments, Consents, Official Plan Amendments, Plans of Subdivision, Plans of Condominium).

Organization of Case Management Conferences and preparation of appeal package documents (notices, affidavits, reports, applications, and forms) for appeals at the Local Planning Appeal Tribunal and Toronto Local Appeal Body.

PROFESSIONAL DEVELOPMENT

Candidate for Registered Professional Planner Designation.

Plain Language Seminar, Ontario Professional Planners Institute, November 2020.

CONTACT

540 Bingham Centre Drive,
Suite 200
Kitchener, ON N2B 3X9
T 519 576 3650 x737
F 519 576 0121
smirtitsch@mhbcplan.com
www.mhbcplan.com



MHBC
P L A N N I N G
U R B A N D E S I G N
& L A N D S C A P E
A R C H I T E C T U R E